



COMMISSIONING GUIDELINES



ASC-4

Automatic Sustainable Controller



1. General information	
1.1 Warnings and notes.....	4
1.2 Legal information and disclaimer.....	4
1.3 Safety issues.....	4
1.4 Electrostatic discharge awareness.....	4
1.5 Factory settings.....	4
1.6 General purpose.....	4
2. Overview	
2.1 Commissioning overview.....	6
2.2 Before commissioning starts.....	7
2.2.1 IP and ID plan.....	7
2.2.2 Power source data.....	8
3. Configuration of digital power meter	
4. Single line diagram	
4.1 Stand-alone application configuration.....	10
4.2 Power management application configuration.....	12
4.2.1 Power management CAN bus.....	14
5. Terminal overview	
6. AC configuration: Scaling	
7. Power supply alarms	
8. Breaker connections	
8.1 PV breaker is present.....	18
8.2 ESS breaker is present.....	19
8.3 Mains breaker is present.....	21
8.4 Generator breaker feedback inputs.....	22
9. Generator configuration	
9.1 Generator parameter settings.....	24
9.2 Power inputs.....	24
10. Mains configuration	
10.1 Mains parameter settings.....	27
11. PV configuratiion	
11.1 PV nominal values.....	28
11.1.1 Nominal ratings.....	28
11.1.2 Nominal current.....	28
11.1.3 Nominal voltage.....	29
11.1.4 Nominal frequency.....	32
12. ESS configuratiion	
12.1 ESS nominal values.....	33
12.1.1 Nominal ratings.....	33
12.1.2 Nominal current.....	33
12.1.3 Nominal voltage.....	34
12.1.4 Nominal frequency.....	37
13. Communication setup	
13.1 General Modbus communication.....	38

13.1.1 Modbus master, Serial 2.....	38
13.2 PV communication.....	40
13.2.1 Modbus master, Serial 1.....	40
13.2.2 Modbus protocol and write type.....	40
13.2.3 Verification of the communication.....	41
13.2.4 Alarms for unicast communication.....	42
13.2.5 Alarms for broadcast communication.....	42
13.3 ESS communication.....	42
13.3.1 Modbus master, Serial 1.....	42
13.3.2 Modbus protocol and write type.....	42
13.3.3 Verification of the communication.....	43
13.3.4 Alarms for unicast communication.....	43
13.3.5 Alarms for broadcast communication.....	44
13.4 ADFweb setup.....	44
14. Emergency stop	
15. Operating modes	
15.1 Stand-alone system.....	48
15.2 Power management system.....	49
16. Spinning reserve	
16.1 Spinning reserve alarms.....	50
16.2 Dynamic spinning reserve.....	50
17. Auto start/stop	
18. Transducer setup	
18.1 Multi-input setup.....	53
18.2 Transducer signals.....	53
18.2.1 4 - 20 mA values.....	53
18.2.2 Translation.....	54
18.3 Test procedure for transducer signals.....	55
18.3.1 Mains transducer.....	56
18.3.2 Transducer testing tables.....	56
19. Appendix A: Modified parameter list	

1. General information

1.1 Warnings and notes

Throughout this document, a number of warnings and notes with helpful user information will be presented. To ensure that these are noticed, they will be highlighted as follows in order to separate them from the general text.

Warnings



DANGER!

Warnings indicate a potentially dangerous situation, which could result in death, personal injury or damaged equipment, if certain guidelines are not followed.

Notes



INFO

Notes provide general information, which will be helpful for the reader to bear in mind.

1.2 Legal information and disclaimer

DEIF takes no responsibility for installation or operation of the generator set. If there is any doubt about how to install or operate the engine/generator controlled by the Multi-line 2 unit, the company responsible for the installation or the operation of the set must be contacted.

NOTE The Multi-line 2 unit is not to be opened by unauthorised personnel. If opened anyway, the warranty will be lost.

Disclaimer

DEIF A/S reserves the right to change any of the contents of this document without prior notice.

The English version of this document always contains the most recent and up-to-date information about the product. DEIF does not take responsibility for the accuracy of translations, and translations might not be updated at the same time as the English document. If there is a discrepancy, the English version prevails.

1.3 Safety issues

Installing and operating the Multi-line 2 unit may imply work with dangerous currents and voltages. Therefore, the installation should only be carried out by authorised personnel who understand the risks involved in working with live electrical equipment.



DANGER!

Be aware of the hazardous live currents and voltages. Do not touch any AC measurement inputs as this could lead to injury or death.

1.4 Electrostatic discharge awareness

Sufficient care must be taken to protect the terminals against static discharges during the installation. Once the unit is installed and connected, these precautions are no longer necessary.

1.5 Factory settings

The Multi-line 2 unit is delivered from the factory with default settings. These are not necessarily correct for the engine/generator set. Check all the settings before running the engine/generator set.

1.6 General purpose

The commissioning guidelines provide information for a thorough, safe and effective commissioning of controller(s), within the system.

**DANGER!**

Commissioning is the most risky period of operation. Commissioning errors can lead to personal injury or death, or equipment damage. These guidelines cannot anticipate or include every possible commissioning problem. Commissioning must therefore be done thoughtfully, systematically and carefully by qualified and experienced personnel.

**INFO**

DEIF does not accept any responsibility for wiring errors.

**INFO**

The controllers interface to third party equipment. DEIF does not accept any responsibility for the operation of third party equipment.

**INFO**

The commissioning guidelines provide information about checking third-party equipment, for example, the switchboard wiring. This information is provided to help ensure a successful commissioning of the entire system. However, DEIF does not accept any responsibility for the operation of third party equipment.

2. Overview

The commissioning guide is for the PV controller in the ASC series.

There are a few steps to follow when the ASC is configured. During the planning of the commissioning job, it can be useful to check whether the ASC is installed in the DEIF cabinet or in a customer-designed cabinet.

This document can be used in both cases.

The document contains the AGC terminal numbers even if installed in a switchboard. Please refer to the switchboard diagrams to see the actual terminal block and terminal number. If in doubt, ask the switchboard designer.

ASC-4	SW version 4.14 or later
-------	--------------------------

2.1 Commissioning overview

Before commissioning starts, a work breakdown structure must be created. The work breakdown structure includes the necessary planning from the start to the end of the commissioning and comprises of mechanical work, electrical DC work, electrical AC work and so on.

This guide only focusses on the work breakdown structure concerning the ASC configuration.

Chapter	DEIF control system commissioning
2.2.1	Create IP list of all devices in the plant with IP addresses and adjust Create list of power meters and inverters connected to the ASC with their ID numbers and baud rate and adjust
2.2.2	Create a complete list of the power source data
3	Configure all DPM from front face with CT ratio, PT ratio and relevant others
4	Establish communication with the ASC with PC Utility SW
4	Configure the application configuration
5	Wiring overview and parameters associated with the terminals
6	Configure AC configuration and scaling of the ASC
7	Configure power supply alarms
8.1	Configure settings for the breaker control and feedbacks PV breaker
8.2	Configure settings for the breaker control and feedbacks ESS breaker
8.3	Configure settings for the breaker feedbacks mains breaker
8.4	Configure input settings for breaker feedbacks
18.1	Configure multi-inputs 102,105,108
9	Configure generator values (nominal, power readings (P/Q) from input and scaling)
10	Configure mains values (power input (P/Q) and scaling)
11	Configure nominal values [U,I,f,P,S,Q,CT ratio, PT ratio] of the PV
12	Configure nominal values [U,I,f,P,S,Q,CT ratio, PT ratio] of the ESS
13.1	Configure DPM for mains incomer (number, ID and baud rate)
13.1	Configure DPM for generator (number, ID and baud rate)
13.2	Configure DPM for PV (number, ID and baud rate)
13.3	Configure DPM for ESS (number, ID and baud rate)
13.1	Configure M-Logic with breaker feedbacks from MIC 4000 series

Chapter	DEIF control system commissioning
13.2, 13.3	Configure inverter type, IDs and baud rate
14	Emergency stop
15	Configure plant modes and set points
15.2	Configure minimum DG load
16	Configure spinning reserve alarms
17	Configure M-Logic with AUTO start/stop
18	Transducer setup

2.2 Before commissioning starts

Before commissioning the ASC-system the commissioning engineer must have an overview of the IP and ID plan, and an overview of the power source data.

2.2.1 IP and ID plan

It is necessary to know all IDs and IP addresses of the plant. Below is an example. Please create a suitable IP plan in Excel so this is ready before commissioning.

These parameters are needed for the commissioning:

- Device
- IP address
- Modbus ID, monitoring
- Modbus ID, control
- Baud rate

Table 2.1 Example of selected communication data for commissioning

Device	IP address	Modbus ID, monitoring	Modbus ID, control	Baud rate
ASC	-	10	-	19200
ADFWEB HD67510	172.170.10.2		0	19200
	-			
Inverter #1	172.170.10.10	10	126	
Inverter #2	172.170.10.11	11	126	
Inverter #3	172.170.10.12	12	126	
Inverter #4	172.170.10.13	13	126	
Inverter #5	172.170.10.14	14	126	
Inverter #6	172.170.10.15	15	126	
Inverter #7	172.170.10.16	16	126	
Inverter #8	172.170.10.17	17	126	
Inverter #9	172.170.10.18	18	126	
DPM - MIC 4002 (mains)	-	1		19200
DPM - MIC 4002 (generator#1)	-	2		19200

Device	IP address	Modbus ID, monitoring	Modbus ID, control	Baud rate
DPM - MIC 4002 (generator#2)	-	3		19200
DPM - MIC 4002 (generator#3)	-	4		19200

Table 2.2 Menus for Ethernet connection

Connection	Function	Associated menus
Ethernet	ASC device IP number	9000 (9002 = IP/Subnet mask) (9003 = Gateway)

2.2.2 Power source data

The power source data must be available before the commissioning starts.

For the example the plant consists of one mains incomer, three generators and nine inverters.

Table 2.3 Example of power source data for plant

Power source	Frequency [Hz]	Voltage [V]	Current [A]	S [VA]	PF	P [kW]	CT ratio	PT ratio	Amount
generator 1	50	400		625	0.8	500	1000/5	1:1	
generator 2	50	400		625	0.8	500	1000/5	1:1	
generator 3	50	400		480	0.8	384	1000/5	1:1	
mains	50	400		600		480	1000/5	1:1	
solar panel						0.265			2100
solar park						557			
inverter size				60					9
inverter total	50	400	779	540			1000/5	1:1	

3. Configuration of digital power meter

With the collected information, it is possible to configure the digital power meters. If transducers are used instead of digital power meters, they must be configured instead.

Depending on the type of power meter, the configuration menu is accessed from the front, and configuration is done from the front. The programming of transducers and power meters are not done from the DEIF PC Utility SW.

On DEIF power meters, for instance MIB 7000C, the configuration menu is typically accessed by pressing "H"+ "VA" simultaneously.

Please refer to the programming manual of your specific meter.

4. Single line diagram

The DEIF controller contains the single line diagram. In DEIF terms, this is represented with the “Application configuration”.

There are two types of application configurations:

- Stand-alone configuration
- Power management configuration

A stand-alone configuration contains only one DEIF ASC controller in the plant configuration.

A power management configuration contains multiple ML-2 controllers (for example, ASC-4 Solar and AGC-4 Genset) in various combinations.

4.1 Stand-alone application configuration

The application can be adjusted by using the PC utility SW. In the tab on the left hand side, the “application configuration” can be selected. Then the configuration is done by selecting the plant specifics.

DEIF utility software - 3.40.0; Connected to "ASC PM Solar" (version 5.04.0 rev. 25075)

File Connection Parameters Help

Area control Plant totals

Area 1 of 1

Area configuration - Top

Source Mains

ID 0

MB Ext/ATS no control

Bottom

Source PV

ID 0

PVB Pulse

< Add Delete Add >

Application 1: PV APPLICATION DK

Area1

Text Timestamp Active Ack status Ack action

<No data to display>

Communication active Connected to "ASC PM Solar" (version 5.04.0 rev. 25075) IP 192.168.100.2 (ID 3)

This example shows the plant with one ASC in a configuration with grid. The number of generators in the application cannot be configured on this screen unless it is a power management application.

The generators are configured in the “Input settings” or in “M-Logic”, they are not included in the application configuration. A maximum of 16 generators can be configured.



Example of stand-alone configuration

This is an example of a stand-alone application where a solar park supplies the load in combination with a mains connection. Two generators are included on an emergency busbar.

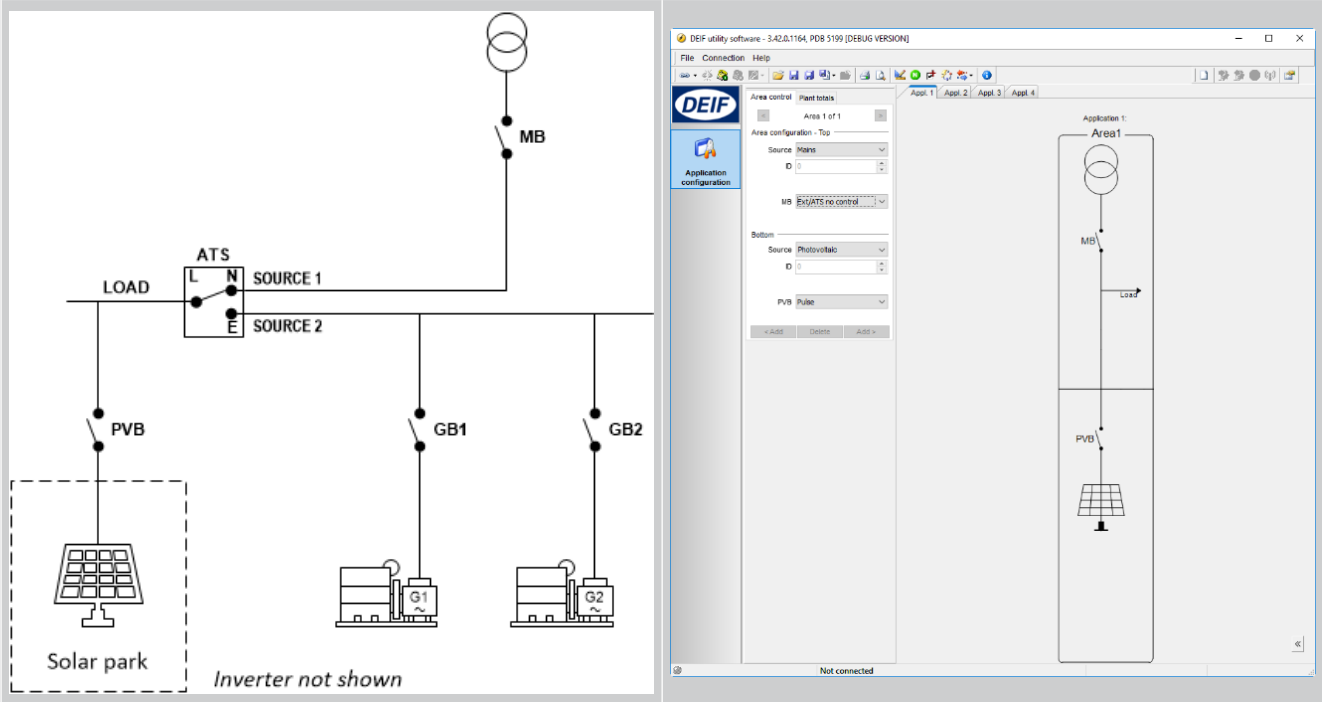

The generators are not visible in the “application configuration”, but they are present in the plant.



More information

See **Generator configuration** in this document for more information about configuring generators.



More information

See **PV configuration** in this document for more information about configuring PV breakers.

4.2 Power management application configuration

The power management provides a lot of combinations. The below screenshot shows only an example.

Special for the power management application is that there is one controller per power source. In the example below, there are five DEIF Multi-line 2 controllers (AGCs and ASCs).

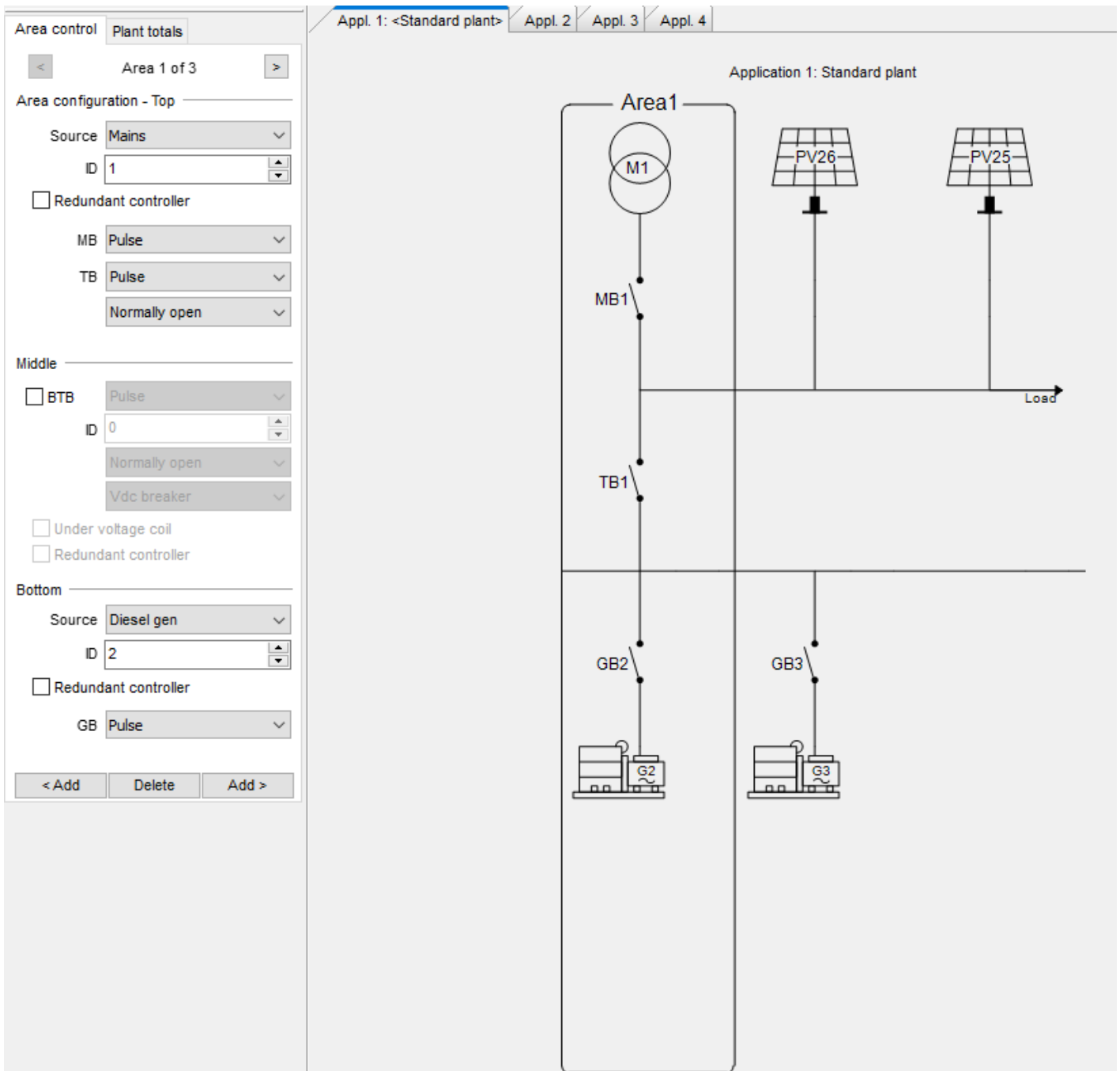

To connect the photovoltaic and battery sources to the Mains load point:

1. The photovoltaic or battery source must be in **Area configuration – Top**.
2. Select the Area with the photovoltaic or battery source.
3. Select **Mains load point** under **Area configuration – Top > Connection**.
4. Write your changes to the controller.

The power management configuration is described in **Option G4 G5 and G8 Power management AGC-4**.



More information

See **Breaker connections** for more information about the wiring and configuration for PV and ESS breakers.

4.2.1 Power management CAN bus

These menus are used if the ASC is part of an integrated system (power management system). The menus are not used if the ASC is the only controller in a stand-alone system.

Terminal	Function		Associated menus
A1	Power management communication	CAN H	7841, CANport select 7870, actions at CAN failure
A3	Power management communication	CAN L	

Notice that the CAN bus line has to be terminated in each end with a 120 Ω resistor. The recommended CAN bus cable is a Belden 3105A or Lapp CAN bus cable or an equivalent cable.

5. Terminal overview

Some basic wiring is needed before engaging the ASC in the system. These terminals must be wired in most cases.

This terminal overview of the ASC is used in the case:

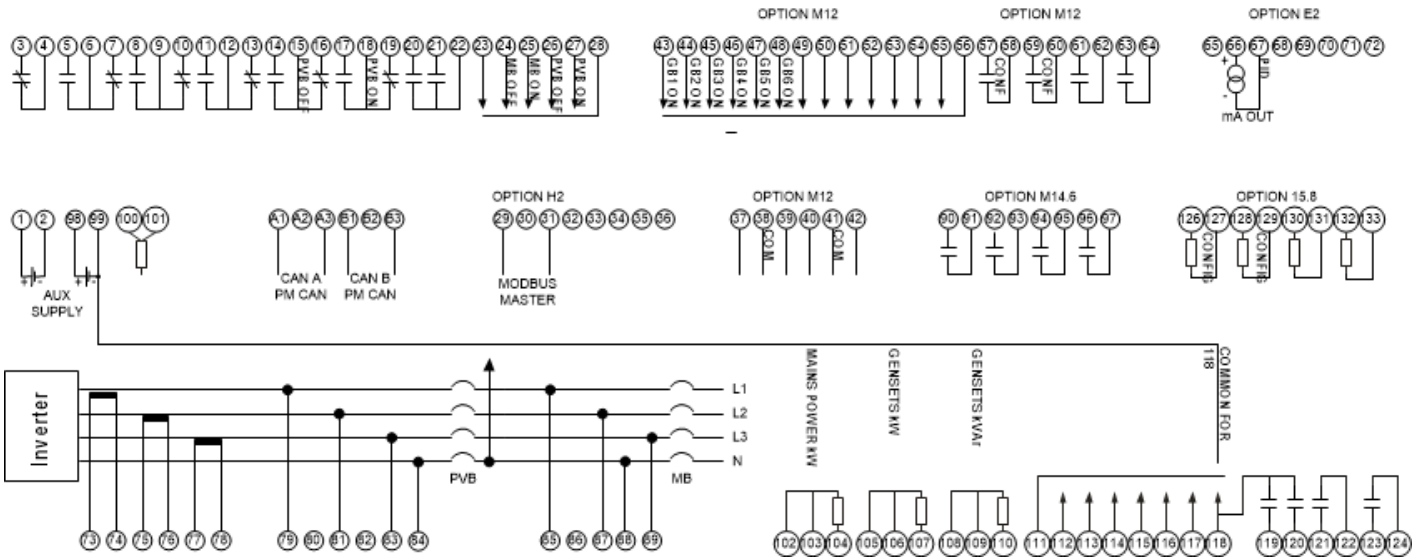

This terminal overview of the ASC contains the hardware options M12-E2-H2-M14.6-M15.8. Other combinations of the option configuration will of course have different terminal overviews. In the installation manual, the precise I/O list of the separate options is shown.

6. AC configuration: Scaling

Select the scaling to the proper setting.

Note that you must do this before the rest of the nominal values are set up.

If this selection is made from the display unit, you must press the key JUMP (keyJUMP, then keyUP or keyDOWN until you reach menu 9030). The master password is still needed.

Parameter	Range	Default	Comment
9030	10 V - 2500 V 100 V - 25000 V 10 kV - 160 kV 1 kV - 75 kV	100 - 25000 V	This parameter affects how the AC measurement values are displayed on the controller. It is recommended to use a scale range that matches your installation.

The difference between the scale ranges is the way the power is displayed on the controller. For example, 6 kW is displayed as 6.0 kW in the 10 - 2500 V scale and 6 kW in the 100 - 25000 V scale. For low power installations, it is recommended to use 10 -2500 V AC.

The screenshot shows the DEIF utility software interface. The title bar indicates the software version (3.42.0.1164, PDB 5199 [DEBUG VERSION]) and the connection to "ASC-4 Solar" (version 4.04.0 rev. 28769). The interface includes a menu bar (File, Connection, Parameters, Help) and a toolbar with various icons. The main window is divided into a left sidebar with navigation icons (Application supervision, Alarms, Trending, Parameters, Inputs/Outputs, Options, Logs, Translations) and a main content area. The main content area is titled "AC Configuration" and contains two sections: "AC config." and "Scaling".

AC config.

- Description: Menu is used to choose between the different AC measurement systems.
- Setpoint: 3 phase L1L2L3

Scaling

- Description: Select the voltage range of operation
- Setpoint: 100V-25000V

7. Power supply alarms

These alarms will activate if the power supply fails. The menus 4980/4990 are only present if the option G5/M4 is installed.

Terminal	Function	Associated menus
1	24 V DC power supply	4960 aux supply low voltage 4970 aux supply high voltage
2	Negative for terminal 1	
98	24 V DC power supply	4980 aux supply low voltage 4990 aux supply high voltage
99	Negative for terminal 98	

8. Breaker connections

8.1 PV breaker is present

If the application configuration includes a PV breaker, the following terminals must be wired:

Terminal	Function		Comments
14	Open PV Breaker	NO	Open relay is used depending on breaker type: pulse
15	Common for 14/16	Comm	
16		NC	
17	Close PV Breaker	NO	Closed relay is used depending on breaker type: pulse and continuous (contactor)
18	Common for 17/19	Comm	
19		NC	

It is noted that the breaker configuration is set up in the "Application configuration". There are no parameter menus for this. Compact breaker (MCCB) is not supported by the ASC.

These menus and inputs associate with each other.

Terminal	Function	Comments
26	Feedback for the PVB open position	2160 PVB open failure 2180 PVB pos failure
27	Feedback for the PVB closed position	2170 PVB close failure 2180 PVB pos failure
28	Common for 26 and 27	

Breaker feedback can be checked in the utility software on the inputs/outputs page. Note that the input terminal numbers are mentioned on the right hand side of the terminal description.

The screenshot shows the DEIF utility software interface. The window title is "DEIF utility software - 3.42.0; Connected to 'ASC-4 Solar' (version 9.91.0 rev. 0)". The interface includes a menu bar (File, Connection, Parameters, Help), a toolbar, and a sidebar with the DEIF logo and "Inputs/Outputs" menu. The main area is divided into two panels: "Input status" and "Output status".

Input status:

<input type="radio"/>	PVB pos. feedb. OFF	26
<input type="radio"/>	PVB pos. feedb. ON	27
<input type="radio"/>	Emergency stop	118
<input type="radio"/>	Digital input 117	117
<input type="radio"/>	Digital input 116	116
<input type="radio"/>	Digital input 115	115
<input type="radio"/>	Digital input 114	114
<input type="radio"/>	Digital input 113	113
<input type="radio"/>	Digital input 112	112

Output status:

<input type="radio"/>	Relay 57	57-58
<input type="radio"/>	Relay 59	59-60
<input type="radio"/>	Relay 61	61-62
<input type="radio"/>	Relay 63	63-64
<input type="radio"/>	Relay 5	5-6-7
<input type="radio"/>	Relay 8	8-9-10
<input type="radio"/>	Relay 11	11-12-13
<input type="radio"/>	Relay 14	14-15-16
<input checked="" type="radio"/>	PVB ON relay	17-18-19
<input type="radio"/>	Relay 20	20-22

Legend: State undetermined (question mark icon), State low (grey circle), State high (green circle). A "Refresh I/O texts" button is present.

Table below Legend:

Text	Timestamp	Active	Ack status	Ack action
<No data to display>				

Status Bar: Communication active | Connected to "ASC-4 Solar" (version 9.91.0 rev. 0) | IP 192.168.11.184 (ID 3)

When there is a PV Breaker in the application and the ASC controls it, the application always contains one:

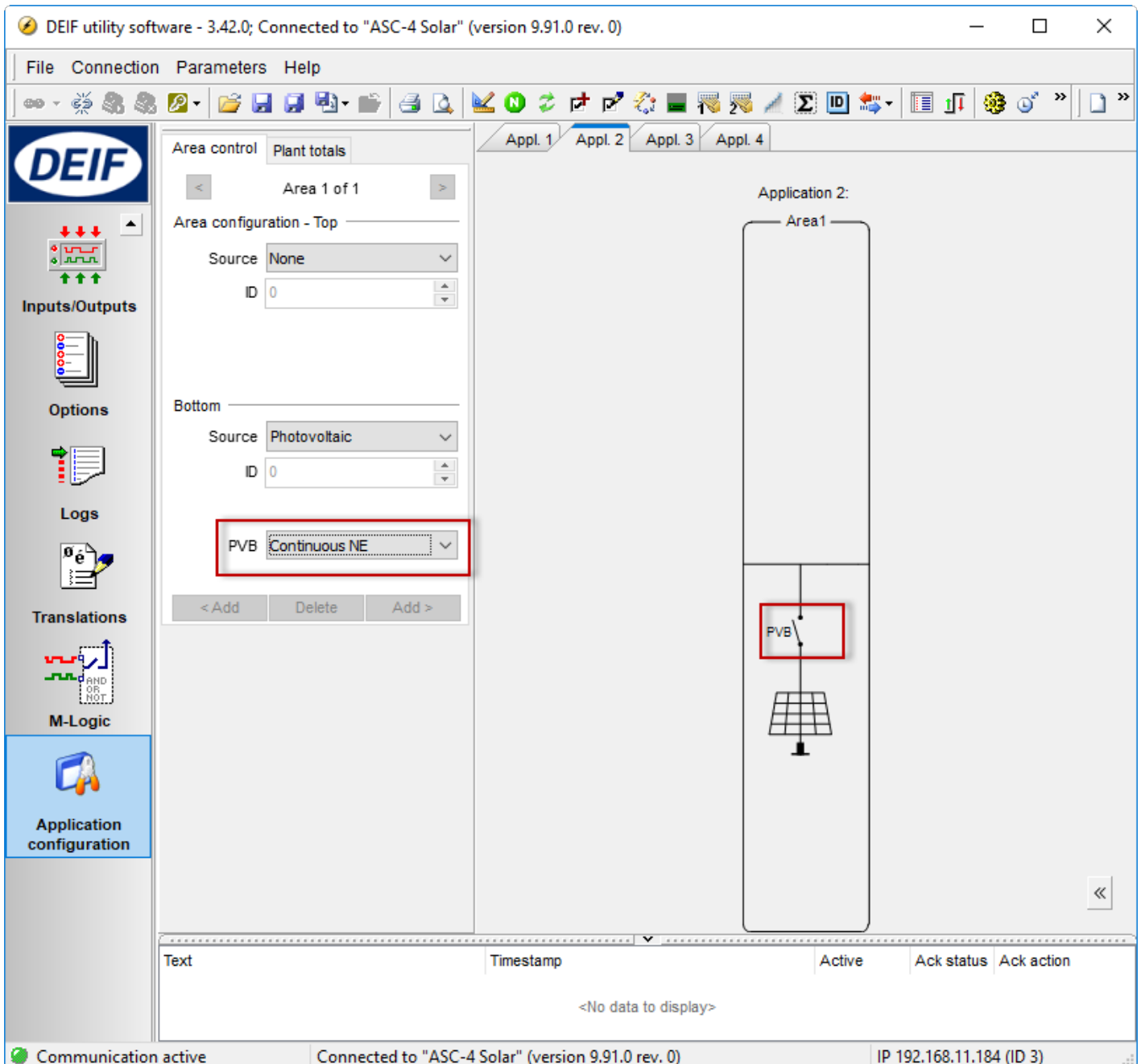

8.2 ESS breaker is present

If the application configuration includes a ESS breaker, the following terminals must be wired:

Terminal	Function		Comments
14	Open ESS Breaker	NO	Open relay is used depending on breaker type: pulse
15	Common for 14/16	Comm	
16		NC	
17	Close ESS Breaker	NO	Closed relay is used depending on breaker type: pulse and continuous (contactor)
18	Common for 17/19	Comm	
19		NC	

It is noted that the breaker configuration is set up in the "Application configuration". There are no parameter menus for this. Compact breaker (MCCB) is not supported by the ASC.

These menus and inputs associate with each other.

Terminal	Function	Comments
26	Feedback for the ESB open position	2160 ESB open failure 2180 ESB pos failure
27	Feedback for the ESB closed position	2170 ESB close failure 2180 ESB pos failure
28	Common for 26 and 27	

Breaker feedback can be checked in the utility software on the inputs/outputs page. Note that the input terminal numbers are mentioned on the right hand side of the terminal description.

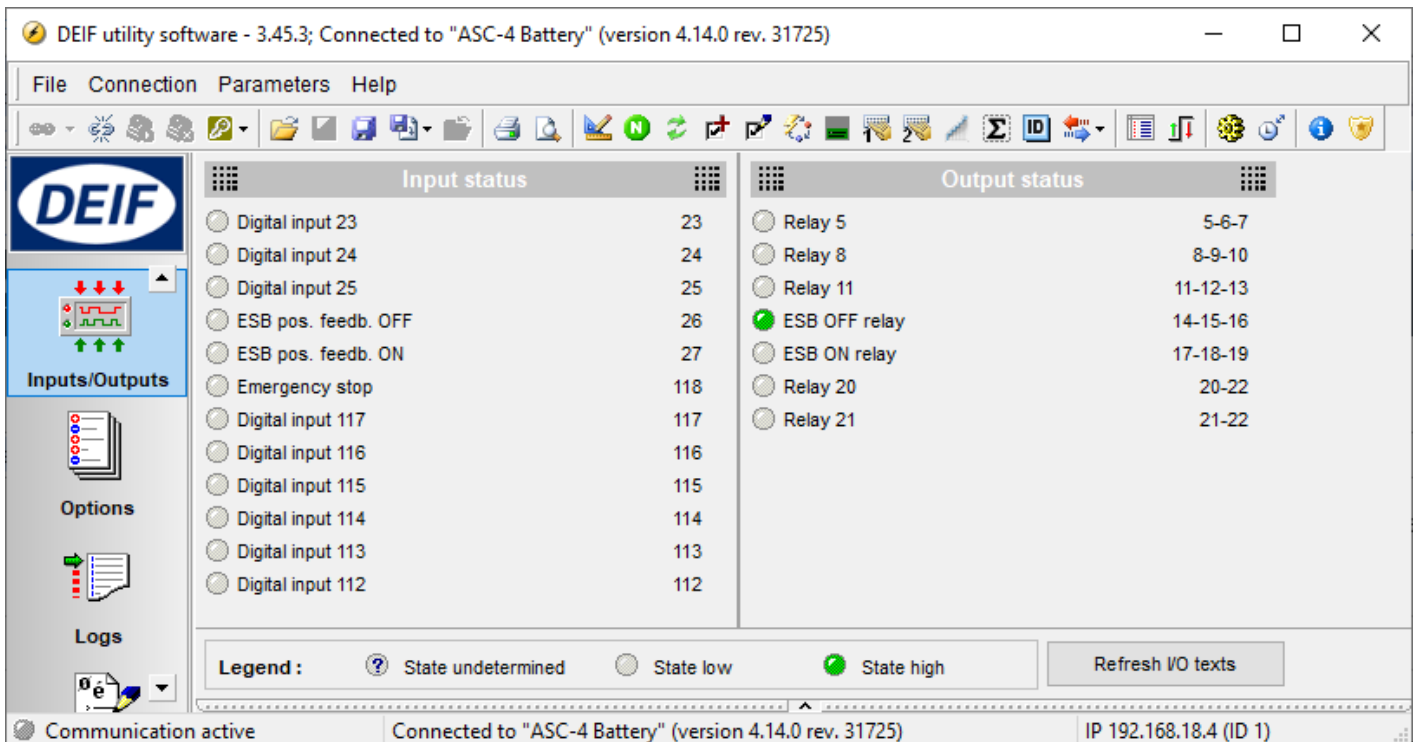

When there is an ESS Breaker in the application and the ASC controls it, the application always contains one:

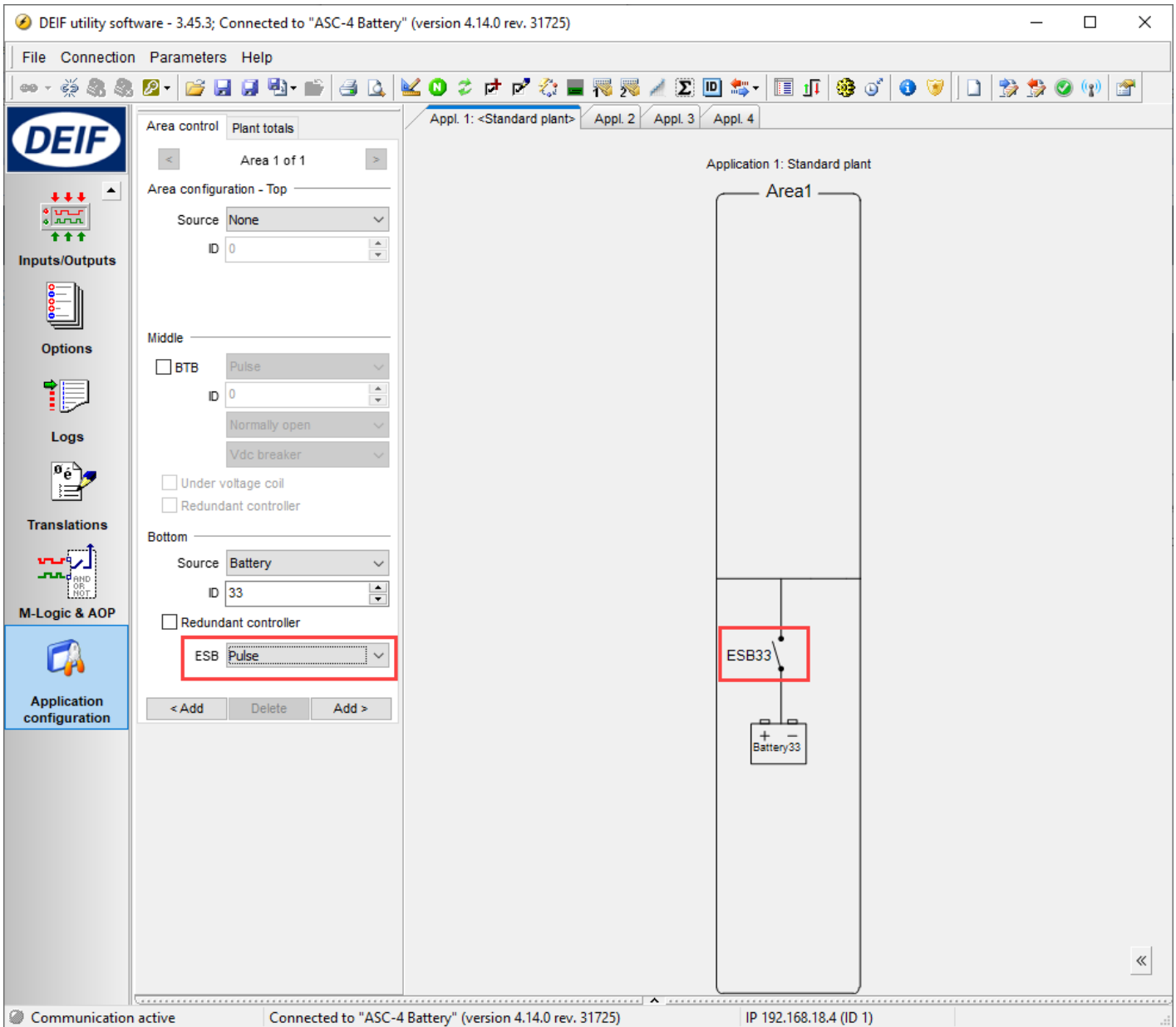

8.3 Mains breaker is present

The ASC cannot control the mains breaker, but it is necessary to wire in position feedbacks so that the ASC knows the status of the mains breaker. This is the case for non-power management systems (ASC is the only DEIF controller in the system).

Terminal	Function	Associated menus
24	Feedback for the MB open position	2210 MB pos failure
25	Feedback for the MB closed position	2210 MB pos failure
28	Common for 24 and 25	

The check of the input functionality is done in the inputs/outputs page similar to the PVB. The application will contain a breaker which is not controlled by the ASC.

The screenshot displays the DEIF utility software interface. The title bar indicates the software version (3.42.0) and the connected device ("ASC-4 Solar" version 9.91.0 rev. 0). The main window is divided into several sections:

- Left Panel:** Contains navigation icons for Inputs/Outputs, Options, Logs, Translations, and M-Logic. The "Application configuration" icon is highlighted.
- Area control:** Shows "Plant totals" and "Area 1 of 1".
- Area configuration - Top:** Includes a "Source" dropdown set to "Mains", an "ID" field set to "0", and a highlighted "MB" dropdown menu set to "Ext/ATS no control".
- Area configuration - Bottom:** Includes a "Source" dropdown set to "Photovoltaic", an "ID" field set to "0", and a "PVB" dropdown set to "Continuous NE".
- Diagram:** Labeled "Application 2: Area1", it shows a schematic of a power source (Mains) connected to a circuit breaker (MB), which is connected to a load and a photovoltaic source (PVB) through a switch (PVB).
- Bottom Panel:** A table with columns for Text, Timestamp, Active, Ack status, and Ack action. It currently displays "<No data to display>".
- Status Bar:** Shows "Communication active", "Connected to 'ASC-4 Solar' (version 9.91.0 rev. 0)", and "IP 192.168.11.184 (ID 3)".

8.4 Generator breaker feedback inputs

The mentioned parameters, wiring and settings must be configured when it is not a power management system. Notice that the DPM DEIF MIC 4000 series also gives the possibility to configure this in the "M-Logic" programming tool.

Note the available number of inputs is option-dependent. The below shown 43-48 (56:common) belong to option M12.

Terminal	Function	Associated menus
43	Genset #1 breaker is closed	7481 DG1 nominal power
44	Genset #2 breaker is closed	7482 DG2 nominal power
45	Genset #3 breaker is closed	7483 DG3 nominal power
46	Genset #4 breaker is closed	7484 DG4 nominal power
47	Genset #5 breaker is closed	7485 DG5 nominal power
48	Genset #6 breaker is closed	7486 DG6 nominal power

Terminal	Function		Associated menus
			Maximum 16 gensets can be configured
56	Common for 43-55	Com.	

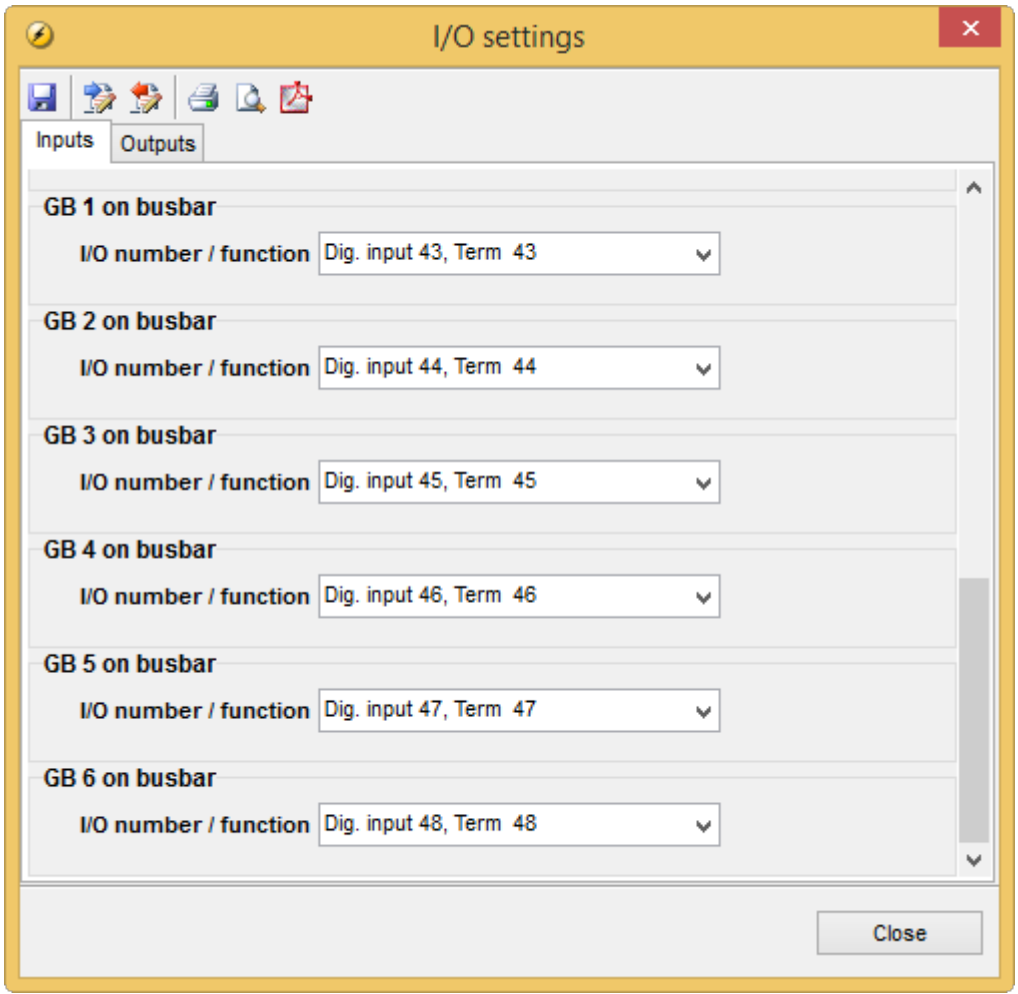

Select the desired inputs in the I/O settings, which are accessed from the horizontal toolbar.

9. Generator configuration

9.1 Generator parameter settings

Before starting on this setup, please adjust the multi-inputs 102, 105, 108 to the needed input type, for instance 4-20 mA inputs. This applies only for units with option G5/M4 and if the transducer inputs are being used.

The chapter describes the configuration and setup of the generator and mains values. It is easily done in the utility software.

You need to go through these steps when the system is a stand-alone system. If the system is an integrated power management system, the ASC retrieves the data from the power management communication lines.

Nominal power

Note that the generator power is adjusted in kW rather than kVA. The kW value can be found by multiplying the kVA value of the generator with the generator power factor.

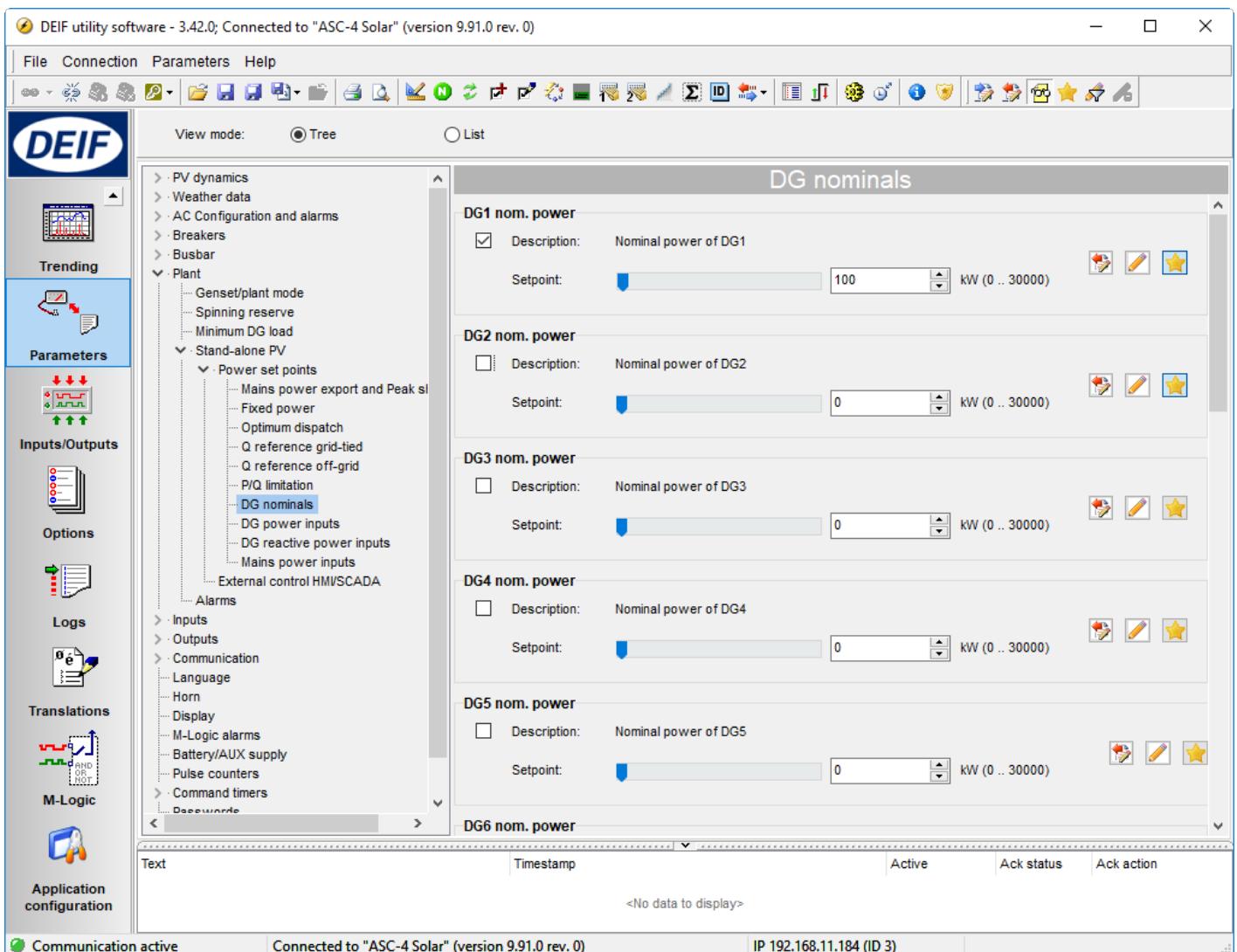

In this example, there is one generator, called DG1 and its size is 100 kW.

9.2 Power inputs

The "power inputs" define where the ASC receives the data from for the generator power.

Active power inputs

The screenshot displays the DEIF utility software interface. The title bar indicates the software version (3.42.0) and the connected device ("ASC-4 Solar" version 9.91.0 rev. 0). The main window is divided into several sections:

- Left Panel:** A navigation tree with categories like Trending, Parameters, Inputs/Outputs, Options, Logs, Translations, M-Logic, and Application configuration. The "Parameters" section is expanded to show "DG power inputs".
- Tree View:** A hierarchical tree view showing the configuration structure. The "DG power inputs" parameter is highlighted.
- Right Panel:** A configuration panel titled "DG power inputs" showing six entries: DG1 P input, DG2 P input, DG3 P input, DG4 P input, DG5 P input, and DG6 P input. Each entry has a description, a setpoint dropdown menu, and three icons (a red arrow, a pencil, and a star). The "Setpoint" for all entries is set to "Multi input 105".
- Bottom Panel:** A table with columns for Text, Timestamp, Active, Ack status, and Ack action. The table is currently empty, displaying "<No data to display>".
- Status Bar:** Shows "Communication active", "Connected to 'ASC-4 Solar' (version 9.91.0 rev. 0)", and "IP 192.168.11.184 (ID 3)".

Above, it is indicated that the ASC uses the multi-input 105 for the input that represents the active power of the generator.

Reactive power inputs

The screenshot displays the DEIF utility software interface. The title bar indicates the software version (3.42.0) and the connected device ("ASC-4 Solar" version 9.91.0 rev. 0). The main window is titled "DG reactive power inputs" and shows a configuration panel for five DG Q inputs (DG1 to DG5). Each input is configured with a description, a checked checkbox, and a setpoint of "Multi input 108". The interface includes a left-hand navigation tree with categories like "Parameters", "Inputs/Outputs", and "Options". The bottom status bar shows "Communication active" and the IP address "IP 192.168.11.184 (ID 3)".

DEIF utility software - 3.42.0; Connected to "ASC-4 Solar" (version 9.91.0 rev. 0)

File Connection Parameters Help

View mode: Tree List

DEIF

Trending

Parameters

Inputs/Outputs

Options

Logs

Translations

M-Logic

Application configuration

PV dynamics

Weather data

AC Configuration and alarms

Breakers

Busbar

Plant

- Genset/plant mode
- Spinning reserve
- Minimum DG load
- Stand-alone PV
 - Power set points
 - Mains power export and Peak sl
 - Fixed power
 - Optimum dispatch
 - Q reference grid-tied
 - Q reference off-grid
 - P/Q limitation
 - DG nominals
 - DG power inputs
 - DG reactive power inputs**
 - Mains power inputs
 - External control HM/SCADA
- Alarms
 - Inputs
 - Outputs
- Communication
 - Language
 - Horn
 - Display
 - M-Logic alarms
 - Battery/AUX supply
 - Pulse counters
 - Command timers
 - Passwords

DG reactive power inputs

DG1 Q input

Description: Input selection for DG1 reactive power

Setpoint: Multi input 108

DG2 Q input

Description: Input selection for DG2 reactive power

Setpoint: Multi input 108

DG3 Q input

Description: Input selection for DG3 reactive power

Setpoint: Multi input 108

DG4 Q input

Description: Input selection for DG4 reactive power

Setpoint: Multi input 108

DG5 Q input

Description: Input selection for DG5 reactive power

Setpoint: Multi input 108

DG6 Q input

Text	Timestamp	Active	Ack status	Ack action
<No data to display>				

Communication active Connected to "ASC-4 Solar" (version 9.91.0 rev. 0) IP 192.168.11.184 (ID 3)

Above, it is indicated that the ASC uses the multi-input 108 for the input that represents the reactive power of the generator.

10. Mains configuration

10.1 Mains parameter settings

The mains configuration is used in stand-alone applications which contain a mains feeder.

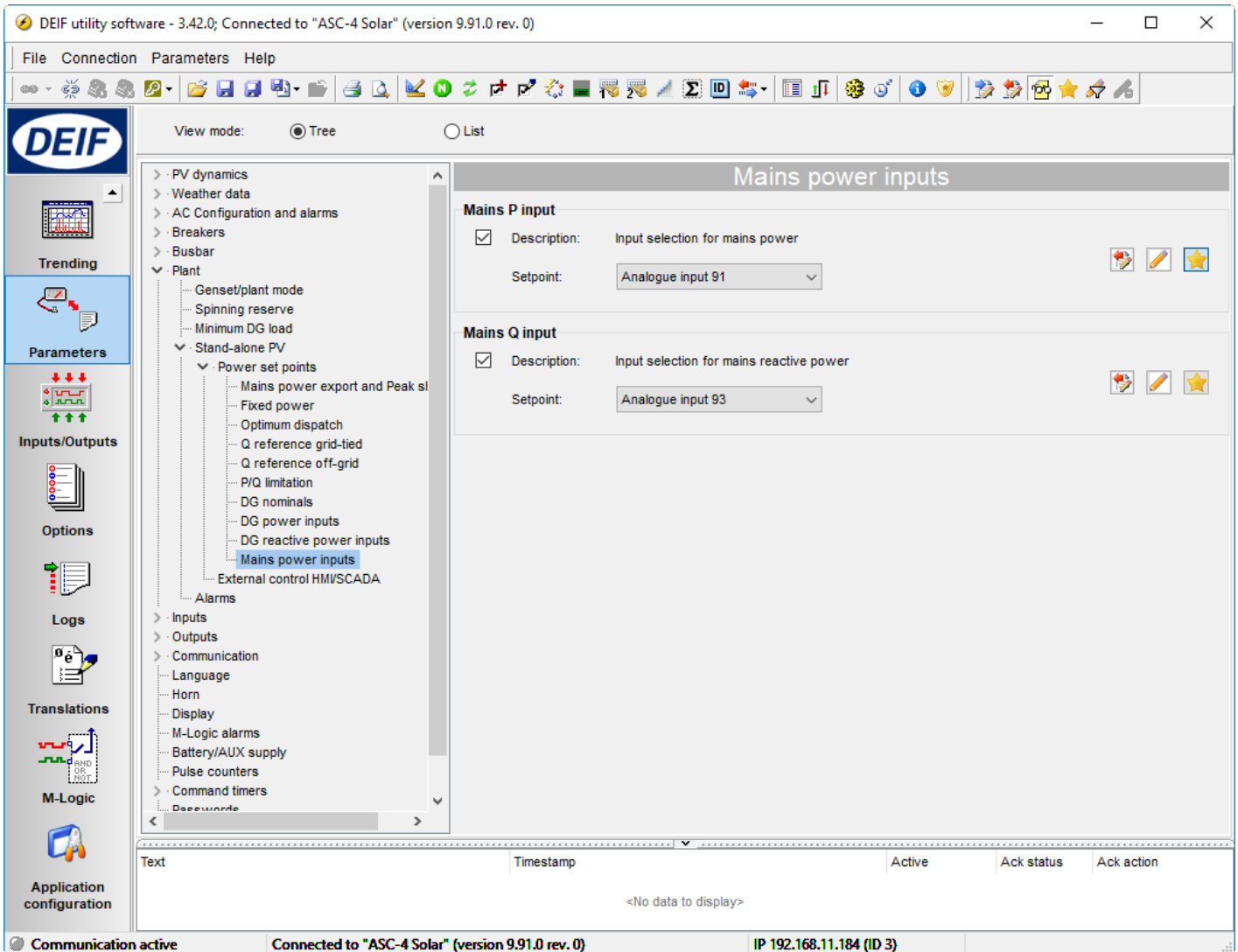

The above shows that the active power of the mains import/export is measured on the analogue input 91 and the reactive power on analogue input 93 (in this example).

It is voluntary to use the “Mains Q input” if the ASC is only doing kW control of the inverters or are running the inverters at a fixed PF.

11. PV configuration

11.1 PV nominal values

In the section “Power source data”, all AC values were collected. Now they can be entered into the ASC.

11.1.1 Nominal ratings

Use the values collected in the **Power source data** chapter to adjust the nominal rating parameter values.

Menu	Function	Comments
6002	Adjust the rating of the installed PV panels.	For example, 200 modules with a 250 Wp rating are installed. Set the value in this menu to $200 \times 250 \times 0.001 = 50$ kW.
6005	Adjust the Q rating of the inverter	If given. Otherwise, set to the same value as 6006.
6006	Adjust the S rating of the inverters.	For example, three 20 kVA inverters are installed. Set this menu to $3 \times 20 = 60$ kVA.

The screenshot shows the DEIF utility software interface. The main window is titled "Nominal Settings" and contains several configuration sections:

- Nom. P 1:** Nominal PV power set point 1. Setpoint: 480 kW (10 .. 20000).
- Nom. Q 1:** Nominal PV reactive power set point 1. Setpoint: 480 kvar (10 .. 20000).
- Nom. S 1:** Nominal PV apparent power set point 1. Setpoint: 480 kVA (10 .. 20000).
- Nom. P 2:** Nominal PV power set point 2. Setpoint: 230 kW (10 .. 20000).
- Nom. Q 2:** Nominal PV reactive power set point 2. Setpoint: 230 kvar (10 .. 20000).
- Nom. S 2:** (Partially visible)

The interface also includes a left sidebar with navigation options like Trending, Parameters, Inputs/Outputs, Options, Logs, Translations, M-Logic, and Application configuration. The status bar at the bottom indicates "Communication active" and "Connected to 'ASC-4 Solar' (version 9.91.0 rev. 0) IP 192.168.11.184 (ID 3)".

11.1.2 Nominal current

The voltage and current measurements need to be connected and set up in the menus.

Terminal	Function		Associated menus
73	PV IL1	S1	6003, I nominal 6043, CT primary 6044, CT, secondary
74	PV IL1	S2	
75	PV IL2	S1	
76	PV IL2	S2	
77	PV IL3	S1	
78	PV IL3	S2	

The screenshot shows the DEIF utility software interface. The title bar indicates it is connected to "ASC-4 Solar" (version 9.91.0 rev. 0). The main window is titled "Nominal Settings" and displays four configuration entries for Nominal PV current set points:

- Nom. I 1:** Description: Nominal PV current set point 1. Setpoint: 867 A (0 .. 9000).
- Nom. I 2:** Description: Nominal PV current set point 2. Setpoint: 345 A (0 .. 9000).
- Nom. I 3:** Description: Nominal PV current set point 3. Setpoint: 345 A (0 .. 9000).
- Nom. I 4:** Description: Nominal PV current set point 4. Setpoint: 345 A (0 .. 9000).

The left sidebar shows a tree view of the configuration structure, with "Nominal Settings" highlighted under the "Current" category. The bottom status bar shows "Communication active", "Connected to 'ASC-4 Solar' (version 9.91.0 rev. 0)", and "IP 192.168.11.184 (ID 3)".

Also adjust the CT settings of the CTs connected to the CT input terminals of the ASC.

11.1.3 Nominal voltage

The voltage measurements need to be connected and set up in the menus.

Terminal	Function		Associated menus
79	UL1	PV	6004, Nominal U 1 6041, BA primary U

Terminal	Function		Associated menus
			6042, BA secondary U
80			
81	UL2	PV	
82			
83	UL3	PV	
84	N	PV	

If no voltage transformer is installed and the voltage is wired directly into the ASC, the ratio is set to 1:1.

For example 415:415 on a 415 volt system.

Terminal	Function		Associated menus
85	UL1	BUS	6051, BB primary U 1 6052, BB second. U 1 6053, BB Nominal U 1
86			
87	UL2	BUS	
88	N	BUS	
89	UL3	BUS	

Notice that the terminal for the neutral is placed between L2 and L3.

The screenshot displays the DEIF utility software interface. The title bar indicates the software version (3.42.0) and the connected device ("ASC-4 Solar" version 9.91.0 rev. 0). The interface includes a menu bar (File, Connection, Parameters, Help), a toolbar, and a sidebar with navigation options like Trending, Parameters, Inputs/Outputs, Options, Logs, Translations, M-Logic, and Application configuration.

The main window is titled "Nominal Settings" and shows a tree view on the left with "Nominal Settings" selected. The right pane displays four settings for "Nom. U":

Setting ID	Description	Setpoint	Range
Nom. U 1	Nominal PV voltage set point 1	400	V (100 .. 25000)
Nom. U 2	Nominal PV voltage set point 2	400	V (100 .. 25000)
Nom. U 3	Nominal PV voltage set point 3	400	V (100 .. 25000)
Nom. U 4	Nominal PV voltage set point 4	400	V (100 .. 25000)

At the bottom, a status bar shows "Communication active", "Connected to 'ASC-4 Solar' (version 9.91.0 rev. 0)", and "IP 192.168.11.184 (ID 3)".

Also adjust the voltage transformer ratio if voltage transformers are used. They must always be checked if the scaling has been configured to 10-2500 V AC.

11.1.4 Nominal frequency

DEIF utility software - 3.42.0; Connected to "ASC-4 Solar" (version 9.91.0 rev. 0)

File Connection Parameters Help

View mode: Tree List

DEIF

Trending

Parameters

Inputs/Outputs

Options

Logs

Translations

M-Logic

Application configuration

- > PV dynamics
- > Weather data
- > AC Configuration and alarms
 - AC power origin
 - AC Configuration
 - > Power
 - > Current
 - > Voltage
 - > Frequency
 - Nominal Settings**
 - Overfrequency Protection
 - Underfrequency Protection
- > Breakers
- > Busbar
- > Plant
 - Genset/plant mode
 - Spinning reserve
 - Minimum DG load
 - > Stand-alone PV
 - > Power set points
 - Mains power export and Peak sl
 - Fixed power
 - Optimum dispatch
 - Q reference grid-tied
 - Q reference off-grid
 - P/Q limitation
 - DG nominals
 - DG power inputs
 - DG reactive power inputs
 - Mains power inputs
 - External control HM/SCADA
 - Alarms
 - > Inputs
 - > Outputs

Nominal Settings

Nom. f 1
 Description: Nominal PV frequency set point 1
 Setpoint: Hz (48 .. 62)

Nom. f 2
 Description: Nominal PV frequency set point 2
 Setpoint: Hz (48 .. 62)

Nom. f 3
 Description: Nominal PV frequency set point 3
 Setpoint: Hz (48 .. 62)

Nom. f 4
 Description: Nominal PV frequency set point 4
 Setpoint: Hz (48 .. 62)

Text	Timestamp	Active	Ack status	Ack action
<No data to display>				

Communication active Connected to "ASC-4 Solar" (version 9.91.0 rev. 0) IP 192.168.11.184 (ID 3)

12. ESS configuration

12.1 ESS nominal values

In the section “Power source data”, all AC values were collected. Now they can be entered into the ASC.

12.1.1 Nominal ratings

Use the values collected in the **Power source data** chapter to adjust the nominal rating parameter values.

Menu	Function	Comments
6002	Set the total power rating of the energy storage system.	
6005	Set the Q rating of the inverter.	If given, otherwise, set to the same value as 6006.
6006	Set the S rating of the inverter.	

12.1.2 Nominal current

The voltage and current measurements need to be connected and set up in the menus.

Terminal	Function		Associated menus
73	ESS IL1	S1	6003, I nominal 6043, CT primary 6044, CT, secondary
74	ESS IL1	S2	
75	ESS IL2	S1	
76	ESS IL2	S2	
77	ESS IL3	S1	
78	ESS IL3	S2	

The screenshot shows the DEIF utility software interface. The title bar indicates it is connected to "ASC-4 Battery" (version 4.14.0 rev. 31725). The main window is titled "Nominal Settings" and displays four configuration entries for nominal ES current set points:

- Nom. I 1:** Description: Nominal ES current set point 1. Set point: 867 A (0 .. 9000).
- Nom. I 2:** Description: Nominal ES current set point 2. Set point: 345 A (0 .. 9000).
- Nom. I 3:** Description: Nominal ES current set point 3. Set point: 345 A (0 .. 9000).
- Nom. I 4:** Description: Nominal ES current set point 4. Set point: 345 A (0 .. 9000).

The first entry (Nom. I 1) is highlighted with a red box. The interface includes a left-hand navigation menu with categories like Parameters, Inputs/Outputs, Options, Logs, Translations, M-Logic & AOP, and Application configuration. The status bar at the bottom shows "Communication active" and the connection details.

Also adjust the CT settings of the CTs connected to the CT input terminals of the ASC.

12.1.3 Nominal voltage

The voltage measurements need to be connected and set up in the menus.

Terminal	Function		Associated menus
79	UL1	ESS	6004, Nominal U 1 6041, BA primary U

Terminal	Function		Associated menus
			6042, BA secondary U
80			
81	UL2	ESS	
82			
83	UL3	ESS	
84	N	ESS	

If no voltage transformer is installed and the voltage is wired directly into the ASC, the ratio is set to 1:1.

For example 415:415 on a 415 volt system.

Terminal	Function		Associated menus
85	UL1	BUS	6051, BB primary U 1 6052, BB second. U 1 6053, BB Nominal U 1
86			
87	UL2	BUS	
88	N	BUS	
89	UL3	BUS	

Notice that the terminal for the neutral is placed between L2 and L3.

DEIF utility software - 3.45.3; Connected to "ASC-4 Battery" (version 4.14.0 rev. 31725)

File Connection Parameters Help

View mode: Tree List

DEIF

Parameters

Inputs/Outputs

Options

Logs

Translations

M-Logic & AOP

Application configuration

> ESS dynamics
 > AC Configuration and alarms
 - AC power origin
 - AC Configuration
 > Power
 > Current
 > Voltage
 - Nominal Settings
 - PT Settings
 - Overvoltage Protection
 - Undervoltage Protection
 - Trip Selection
 > Frequency
 > Breakers
 > Busbar
 > Plant
 > ESS
 > Inputs
 > Outputs
 > Communication
 Language
 Horn
 Display
 M-Logic alarms
 Battery/AUX supply
 Pulse counters
 Command timers
 Passwords
 > Application

Nominal Settings

Nom. U 1

Description: Nominal ES voltage set point 1

Set point: V (100 .. 25000)

Nom. U 2

Description: Nominal ES voltage set point 2

Set point: V (100 .. 25000)

Nom. U 3

Description: Nominal ES voltage set point 3

Set point: V (100 .. 25000)

Nom. U 4

Description: Nominal ES voltage set point 4

Set point: V (100 .. 25000)

Communication active | Connected to "ASC-4 Battery" (version 4.14.0 rev. 31725) | IP 192.168.18.4 (ID 1)

Also adjust the voltage transformer ratio if voltage transformers are used. They must always be checked if the scaling has been configured to 10-2500 V AC.

12.1.4 Nominal frequency

The screenshot displays the DEIF utility software interface. The title bar indicates the software version is 3.45.3 and it is connected to "ASC-4 Battery" (version 4.14.0 rev. 31725). The main window is divided into a left sidebar and a main content area.

Left Sidebar: Contains navigation icons for Parameters, Inputs/Outputs, Options, Logs, Translations, M-Logic & AOP, and Application configuration. A tree view on the left shows the following structure:

- ESS dynamics
 - AC Configuration and alarms
 - AC power origin
 - AC Configuration
 - Power
 - Current
 - Voltage
 - Frequency
 - Nominal Settings**
 - Overfrequency Protection
 - Underfrequency Protection
 - Breakers
 - Busbar
 - Plant
 - ESS
 - Inputs
 - Outputs
 - Communication
 - Language
 - Horn
 - Display
 - M-Logic alarms
 - Battery/AUX supply
 - Pulse counters
 - Command timers
 - Passwords
 - Application

Main Content Area: Titled "Nominal Settings", it lists four frequency set points:

Set Point	Description	Set Point Value	Unit
Nom. f 1	Nominal ES frequency set point 1	50	Hz (48 .. 62)
Nom. f 2	Nominal ES frequency set point 2	50	Hz (48 .. 62)
Nom. f 3	Nominal ES frequency set point 3	60	Hz (48 .. 62)
Nom. f 4	Nominal ES frequency set point 4	60	Hz (48 .. 62)

The "Nom. f 1" section is highlighted with a red border. The interface includes a status bar at the bottom with the text: "Communication active", "Connected to 'ASC-4 Battery' (version 4.14.0 rev. 31725)", and "IP 192.168.18.4 (ID 1)".

13. Communication setup

13.1 General Modbus communication

13.1.1 Modbus master, Serial 2

The ASC can read the power (active and reactive) from various digital power meters or Modbus devices. The Modbus serial communication connections are located in slot #8 in the ASC as shown:

Terminal	Function	Associated menus
131	Modbus communication	B 7720, DPM protocol type (for example DEIF MIB 7000C) and number of nodes 7730-7750, action at DPM Communication error (Modbus master) 7700 Comm ID and baud rate 7710, action at communication error
133	Modbus communication	A

Note that the meters have their own Modbus parameters (ID and baud rate). Adjust these on the meters directly, typically on the front display of the DPM.

Note that when using the Modbus master, serial 2 for measuring the mains, generator and/or PV power, it is not necessary to use the transducers for measuring the power sources.

Breaker feedback on DPM

MIC 4002 and MIC 4224 include inputs that can be used as various breaker feedbacks. This is practical if the DPM is installed near the generator so additional feedback wiring over a large distance is avoided.

In DEIF M-Logic, the feedbacks are configured. This example includes 3 generators and 1 mains incomer.

The screenshot displays the DEIF M-Logic configuration interface with five logic rules:

- Logic 1:** Event A: DG Power meter1 input1: DG power meter inputs; Operator: OR; Event B: Not used; Output: GB1 closed feedback: GB feedbacks.
- Logic 2:** Event A: DG Power meter2 input1: DG power meter inputs; Operator: OR; Event B: Not used; Output: GB2 closed feedback: GB feedbacks.
- Logic 3:** Event A: DG Power meter3 input1: DG power meter inputs; Operator: OR; Event B: Not used; Output: GB3 closed feedback: GB feedbacks.
- Logic 4:** Event A: Mains Power meter1 input1: Mains power meter inputs; Operator: OR; Event B: Not used; Output: MB closed feedback: MB feedbacks.
- Logic 5:** Event A: Mains Power meter1 input2: Mains power meter inputs; Operator: OR; Event B: Not used; Output: MB open feedback: MB feedbacks.

Notice that in the M-Logic, the power meter number should be read as “the first”, “the second”, “the third” and so on.

Example:

Device	Modbus ID, monitoring	Logic line (in example)	Associated DPM
DPM - MIC 4002 (mains)	1	4/5	Mains power meter 1
DPM - MIC 4002 (generator#1)	2	1	DG power meter 1
DPM - MIC 4002 (generator#2)	3	2	DG power meter 2
DPM - MIC 4002 (generator#3)	4	3	DG power meter 3

Note that the Modbus ID must strictly be configured as different. And its assignment can be given depending on where it is connected, for instance generator breaker closed feedback.

Table 13.1 Example of Modbus ID allocation

Common point of connection or building	Power source	Modbus DPM	Modbus ID (M-Logic order)
Building 1	PV#1	MIC 4002	1
Building 2	PV#2	MIC 4002	2
Building 3	PV#3	MIC 4002	3
Building 4	PV#4	MIC 4002	4
Building 5	PV#5	MIC 4002	5
Building 6	PV#6	MIC 4002	6
Building 7	PV#7	MIC 4002	7
Building 8	PV#8	MIC 4002	8
Building 9	PV#9	MIC 4002	9
Building 10	PV#10	MIC 4002	10
Basement MSB	DG1	MIC 4002	11 (first)
Basement MSB	DG2	MIC 4002	12 (second)
Basement MSB	DG3	MIC 4002	13 (third)
Mains Tx	Transformer #1	MIC-2	14
Mains Tx	Transformer #2	MIC-2	15

M-Logic orders are used when configuring the breaker feedbacks on the MICs.

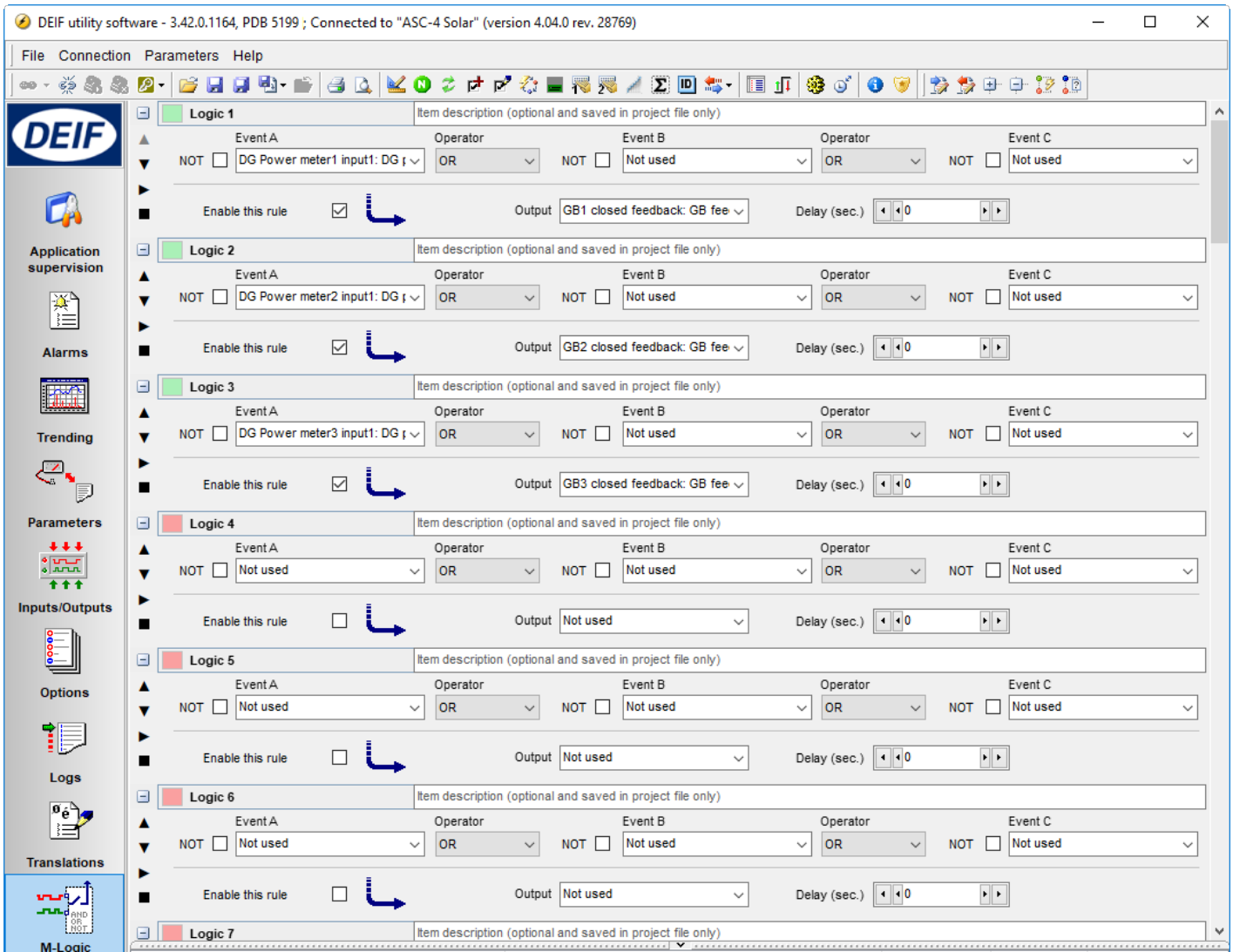

13.2 PV communication

13.2.1 Modbus master, Serial 1

Using the communication interface requires the use of Modbus master for the Sunspec-supported inverters or inverters with proprietary protocols.

Terminal	Function		Associated menus
29	Modbus communication	A	7561, PV Comm type (for example Sunspec) 7570, action at PV Communication error (Modbus master) 7510 Ext comm ID and Baud rate 7520, action at communication error (Modbus slave)
31	Modbus communication	B	

Note that the Modbus line should be properly terminated. Long lines typically with 120 Ohm in each. For short lines, it is often seen that the termination can be removed, but it also depends on the inverter type.

Note that the Modbus ID in the inverter can be set to the same as in the ASC. The baud rate has to be the same in the ASC and the inverter.

13.2.2 Modbus protocol and write type

The Modbus transmit specifics is set in menu 7560:

- 7561, select the inverter type.
- 7562, select broadcast or unicast.
 - Broadcast at multiple string inverters.
 - Unicast at single string inverters or central inverters.
- 7563, transmit rate, set it to 1-2 seconds. Don't set it below 1 second unless advised to.
- 7564, transmit telegram, use 0x06h prior to 0x10h. Switch to 0x10h if 0x06h is not responding.

Schneider, ABB uses 0x10h, Fronius, SMA uses 0x06h, inverters following Sunspec uses 0x06h.

13.2.3 Verification of the communication

Notice that it is often convenient to start with the communication adjusted to “UNICAST” even though broadcast is eventually going to be used.

Inverter number	Inverter Modbus ID	Baud rate selected	DEIF ASC comm. ID
1	10	19200	Menu 7511
2	11	19200	Menu 7511
3	12	19200	Menu 7511

Now switch to unicast and adjust the DEIF ASC to a proper ID:

Inverter number	Inverter Modbus ID	Baud rate selected	DEIF ASC comm. ID
1	10	19200	10
2	11	19200	-
3	12	19200	-

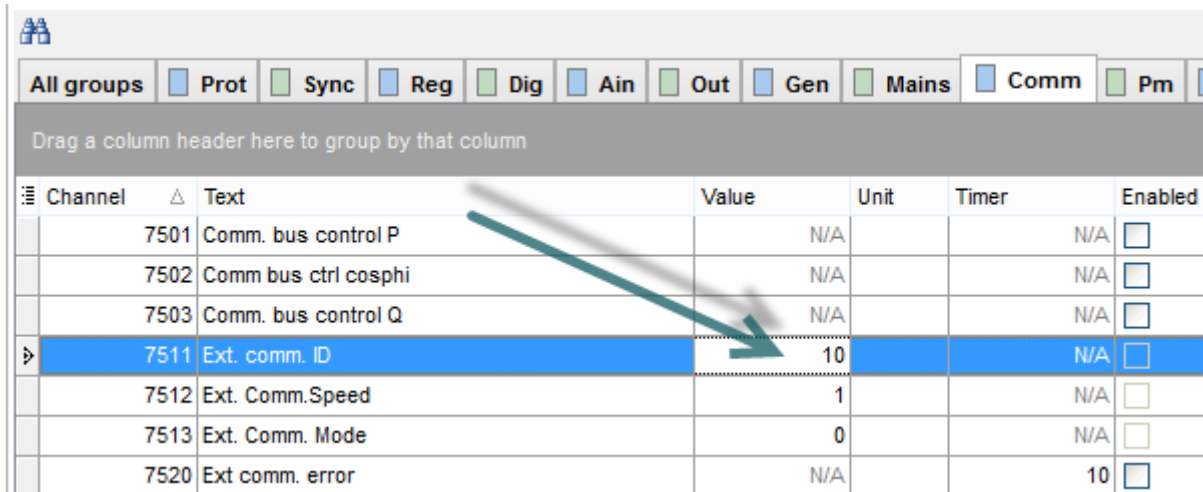

This means that the inverter number 1 will be tested and should respond to the ASC set points. By switching the menu 7511 to ID11 and ID12 (in this example), the other two inverters can be tested.

This means that the communication can be verified and eventually switched to “broadcast” (where all three inverters will respond).

Not all inverters support this method of using unicast.

13.2.4 Alarms for unicast communication

Three alarms can be used when using the unicast approach (due to the continuous handshake with the inverter communications). In a communication topology where the broadcast method is used, the alarms can be switched off due to one-sided communication (ASC > inverter).

7570	PV COMM error	N/A		3	<input checked="" type="checkbox"/>
7580	PV Warning	N/A		3	<input checked="" type="checkbox"/>
7590	PV Shutdown	N/A		0	<input checked="" type="checkbox"/>

- 7570, PV comm error
- 7580, PV warning
- 7590, PV shutdown

Enable the alarms and configure the appropriate actions.

13.2.5 Alarms for broadcast communication

When broadcast is used and the inverters receive set points using broadcast frames, the PV Monitoring alarm can be used. This is only the case if “PV monitoring” is switched on and receiving data back from the inverters.

If the broadcast frames are sent to a common inverter manager, for instance Fronius Data Manager Box 2.0, the ASC does not retrieve data from the inverters. Then the alarm “PV Monitoring error” cannot be used.

- 7570, PV comm error
- 7580, PV monitoring error

Enable the alarms and configure the appropriate actions.

13.3 ESS communication

13.3.1 Modbus master, Serial 1

Using the communication interface requires the use of Modbus master for the inverters with proprietary protocols.

Terminal	Function		Associated menus
29	Modbus communication	A	7561, ESS protocol 7570, ESS communication error action (Modbus master) 7510 External communication ID and Baud rate 7520, external communication error action (Modbus slave)
31	Modbus communication	B	

Note that the Modbus line should be properly terminated. Long lines typically with 120 Ohm in each. For short lines, it is often seen that the termination can be removed, but it also depends on the inverter type.

Note that the Modbus ID in the inverter can be set to the same as in the ASC. The baud rate has to be the same in the ASC and the inverter.

13.3.2 Modbus protocol and write type

Modbus transmit specifications are set in menu 7560:

- 7561, select the communication type.

- 7562, select broadcast or unicast.
 - Broadcast at multiple string inverters.
 - Unicast at single string inverters or central inverters.
- 7563, transmit rate, set it to 1-2 seconds. Don't set it below 1 second unless advised to.
- 7564, transmit telegram, use 0x06h prior to 0x10h. Switch to 0x10h if 0x06h is not responding.

13.3.3 Verification of the communication

Notice that it is often convenient to start with the communication adjusted to “unicast” even though broadcast is eventually going to be used.

Inverter number	Inverter Modbus ID	Baud rate selected	DEIF ASC comm. ID
1	10	19200	Menu 7511
2	11	19200	Menu 7511
3	12	19200	Menu 7511

Now switch to unicast and adjust the DEIF ASC to a proper ID:

Inverter number	Inverter Modbus ID	Baud rate selected	DEIF ASC comm. ID
1	10	19200	10
2	11	19200	-
3	12	19200	-

Char	Text	Address	Value	Unit	Timer	OutputA	OutputB	Enab
7501	Comm. bus control P	557	N/A		N/A	N/A	N/A	<input type="checkbox"/>
7502	Comm bus ctrl cosphi	560	N/A		N/A	N/A	N/A	<input type="checkbox"/>
7503	Comm. bus control Q	561	N/A		N/A	N/A	N/A	<input type="checkbox"/>
7511	Ctrl. comm. ID	562	10		N/A	N/A	N/A	<input type="checkbox"/>
7512	Mon. comm. ID	574	3		N/A	N/A	N/A	<input type="checkbox"/>
7514	Ext. Comm 1 Spd	563	1		N/A	N/A	N/A	<input type="checkbox"/>
7515	Ext. Comm 1 Mod	564	0		N/A	N/A	N/A	<input type="checkbox"/>
7520	Ext comm 1 err.	565	N/A		10	Not us...	Not used	<input type="checkbox"/>

This means that the inverter number 1 will be tested and should respond to the ASC set points. By switching the menu 7511 to ID11 and ID12 (in this example), the other two inverters can be tested.

This means that the communication can be verified and eventually switched to “broadcast” (where all three inverters will respond).

Not all inverters support this method of using unicast.

13.3.4 Alarms for unicast communication

Three alarms can be used when using the unicast approach (due to the continuous handshake with the inverter communications). In a communication topology where the broadcast method is used, the alarms can be switched off due to one-sided communication (ASC > inverter).

- 7570, ESS comm error
- 7580, ESS warning
- 7590, ESS shutdown

Enable the alarms and configure the appropriate actions.

13.3.5 Alarms for broadcast communication

When broadcast is used and the inverters receive set points using broadcast frames, the ESS Monitoring alarm can be used. This is only the case if “ESS monitoring” is switched on and receiving data back from the inverters.

If the broadcast frames are sent to a common inverter manager, for instance Fronius Data Manager Box 2.0, the ASC does not retrieve data from the inverters. Then the alarm “ESS Monitoring error” cannot be used.

- 7570, ESS communication error
- 7600, ESS monitoring error

Enable the alarms and configure the appropriate actions.

13.4 ADFweb setup

In order to install the ADFweb HD67510 device in the application where it is required, for example using SMA STP25000 TL, follow these steps:

1. Install the PC utility from www.adfweb.com and find the utility on the free download page.
2. Make a configuration with the relevant settings.

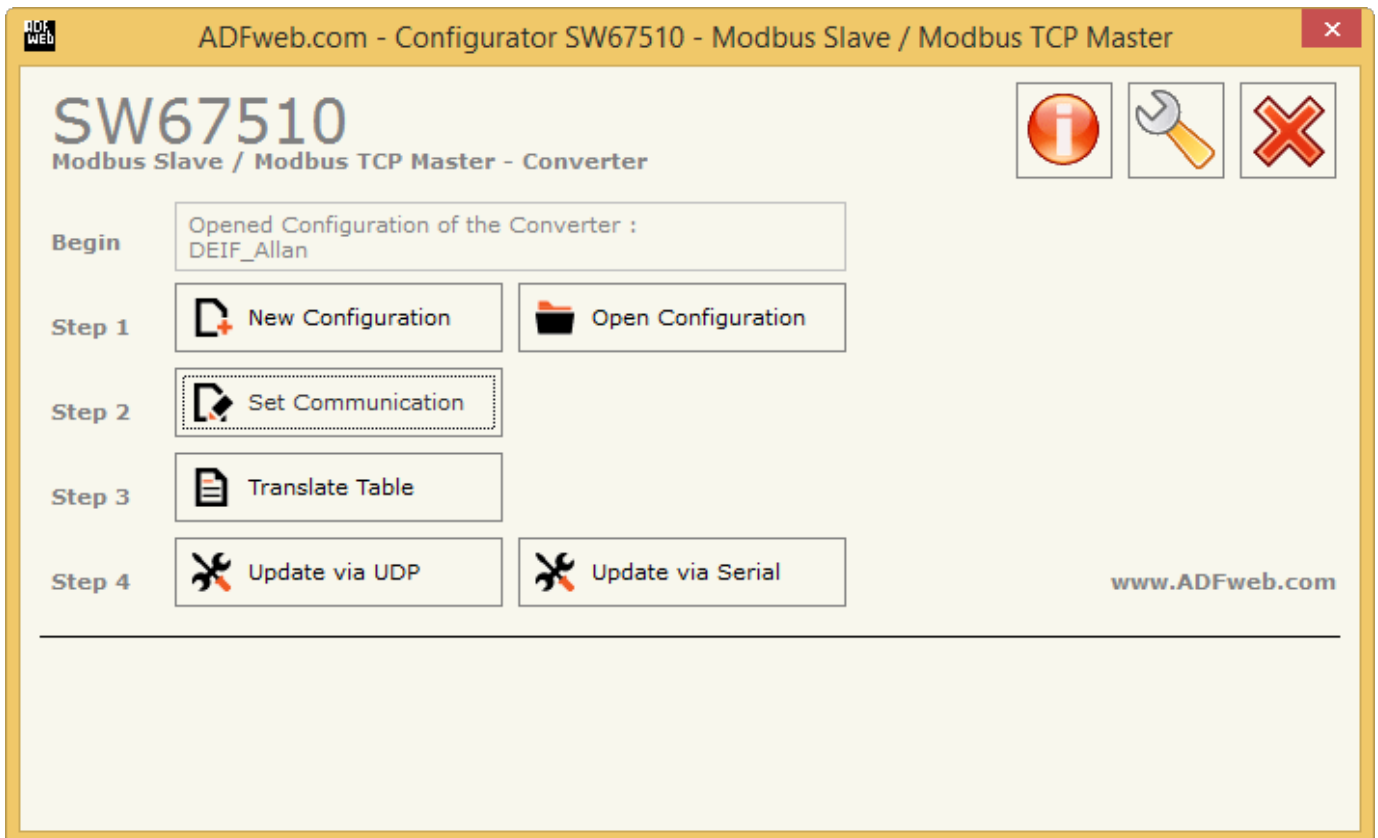

3. When setting up the communication:
 - a. Use the routing table
 - b. Set up the IP address you intend the HD67510 to have
 - c. Set up the Modbus slave details (communication to DEIF ASC)
 - d. Don't disconnect the socket
 - e. Enable broadcast with ID 0

SW67510
Set Communication Setting

Operation Mode
Routing Slave Address

Modbus TCP Master

IP ADDRESS
192 . 168 . 0 . 10

SUBNET Mask
255 . 255 . 255 . 0

GATEWAY
192 . 168 . 0 . 1

Port 502

TimeOut (ms) 1000

Don't disconnect the socket

Modbus Slave

Serial RS485

Baudrate 9600

Parity NONE

ID Device 1

Enable Broadcast message with ID zero

OK Cancel

4. Set up the translate table:

- a. Set up slave ID 0 for broadcast using UDP Broadcast and route it to the IP of the inverter.
 - Note that the desired slave ID address of the inverter has to be checked in the user manual of the inverter – 126 is for example for SMA STP25000 TL.
- b. Repeat steps for the number of IP addresses you have in your system (the example below shows a system with two (2) inverters).
- c. For remote monitoring (ASC reads from inverters), set up the translate table with your connected inverters, for example in this case, there are two inverters where the ASC reads from ID10 and ID11.
- d. All connected inverters must be included in the table for remote monitoring.

ADF WEB Translate Table

SW67510

Set Translate Table

N°	Slave ID	IP Address TCP	Slave ID TCP	Reserved Sock	Errors Sock	UDP	Broadcast	Mnemonic
1	0	192.168.0.101	126	<input type="checkbox"/>		<input checked="" type="checkbox"/>	<input checked="" type="checkbox"/>	
2	0	192.168.0.102	126	<input type="checkbox"/>		<input checked="" type="checkbox"/>	<input checked="" type="checkbox"/>	
3	10	192.168.0.101	126	<input type="checkbox"/>		<input type="checkbox"/>	<input type="checkbox"/>	
4	11	192.168.0.102	126	<input type="checkbox"/>		<input type="checkbox"/>	<input type="checkbox"/>	
5				<input type="checkbox"/>		<input type="checkbox"/>	<input type="checkbox"/>	
6				<input type="checkbox"/>		<input type="checkbox"/>	<input type="checkbox"/>	
7				<input type="checkbox"/>		<input type="checkbox"/>	<input type="checkbox"/>	
8				<input type="checkbox"/>		<input type="checkbox"/>	<input type="checkbox"/>	
9				<input type="checkbox"/>		<input type="checkbox"/>	<input type="checkbox"/>	
10				<input type="checkbox"/>		<input type="checkbox"/>	<input type="checkbox"/>	

OK
 Cancel
 Delete Row
 Insert Row

5. Update the settings to the ADFweb (check ADFweb manual for factory IP address).

Update Firmware from Etherner (UDP)

SW67510

Update Firmware from Etherner (UDP)

Insert the IP Address of HD67510

192 . 168 . 2 . 205

Check the Connection the device

Ping

Cancel Next



INFO

Notice the dip switch position of the ADFweb. Both dip 1 and dip 2 have to be checked according to the manual from ADFweb. If one them is wrong, you cannot programme the device.

14. Emergency stop

The emergency stop will send a 0 kW reference to the PV plant and open the PV breaker if it is present.

The fail class can be selected to warning if the alarm input has to be used for other purpose.

Menu	Function		Comments
3490	Emergency stop details		Emergency stop alarm consists of sub menus.
3491	Timer		If used as e-stop then select 0 sec.
3492	Relay output for PLC	OA	
3493	Relay output for PLC	OB	
3494	Enable this alarms		
3495	Select fail class		If used as e-stop, then select S/D.

15. Operating modes

All modes are described in the designer's reference handbook of the ASC and the AGC in more details.

15.1 Stand-alone system

In a stand-alone system, the requested mode is adjusted in the menu 6071.

Parameter	Range	Menu group	Notes
6071	Island mode Fixed power Mains power export Power management	6070	A stand-alone system can only run in Island mode, Fixed power, or mains power export.

Set points off-grid

In off-grid mode, the set point will be as high as possible but will be curtailing the PV in order to keep the genset minimum load. There are two different min. load settings in case you have different engine types.

The screenshot shows the DEIF utility software interface. The title bar indicates the software version (3.42.0.1164) and connection to "ASC-4 Solar" (version 4.04.0 rev. 28769). The menu bar includes File, Connection, Parameters, and Help. The interface is divided into several sections:

- Left Panel:** Contains navigation icons for Application supervision, Alarms, Trending, Parameters (highlighted), Inputs/Outputs, Options, Logs, and Translation.
- Tree View:** Shows a hierarchical menu structure under "Plant", including "Stand-alone PV" and "Power set points".
- Main Configuration Area:**
 - Minimum DG load 01:** Description: "Minimum DG load percentage in island operation 1". Setpoint: 30% (-50 .. 100).
 - Minimum DG load 02:** Description: "Minimum DG load percentage in island operation 2". Setpoint: 30% (-50 .. 100).
 - Min DG load set:** Description: "Minimum DG load percentage island selection". Setpoint: "Min. DG load set 1".
 - DG P< 1:** Description: "DG reverse power alarm 1". Setpoint: -5% (-200 .. 100). Timer: 10 sec (0,1 .. 3200). Failclass: "Warning".
 - DG P< 2:** Description: "DG reverse power alarm 2".
- Bottom Panel:** A table with columns: Text, Timestamp, Active, Ack status, Ack action. It currently displays "<No data to display>".
- Status Bar:** Shows "Communication active", "Connected to 'ASC-4 Solar' (version 4.04.0 rev. 28769)", and "IP 192.168.11.184 (ID 3)".

Set points grid-tied

The set points during grid-tied operation are adjusted in the ASC. In the tree structure, the peak shaving, power export and fixed power values can be selected and adjusted.

15.2 Power management system

In an integrated system, the power management selection is needed. The actual mode is transmitted on the power management communication.

Table 15.1 Plant mode parameter

Parameter	Range	Menu group	Notes
6071	Island mode Fixed power Mains power export Power management	6070	For a power management system, this parameter must be set to Power management.

Set points

The set points are communicated with the power management system. For the DG minimum load setting, refer to the same settings as mentioned in the stand-alone system above.

16. Spinning reserve

Spinning reserve alarms can be used to start additional generators when the alarm is activated, or the ASC can notify the genset controllers to start or stop generators in a power management solution to manage the available spinning reserve.

16.1 Spinning reserve alarms

Two alarms can be enabled. They can drive alarm relays and display alarms. These signals can be used as a driver to start additional generators or trip load groups. Since the DEIF controller only raises the alarm, the associated actions must be configured in the peripheral system (for instance third party genset controllers and load groups PLCs).

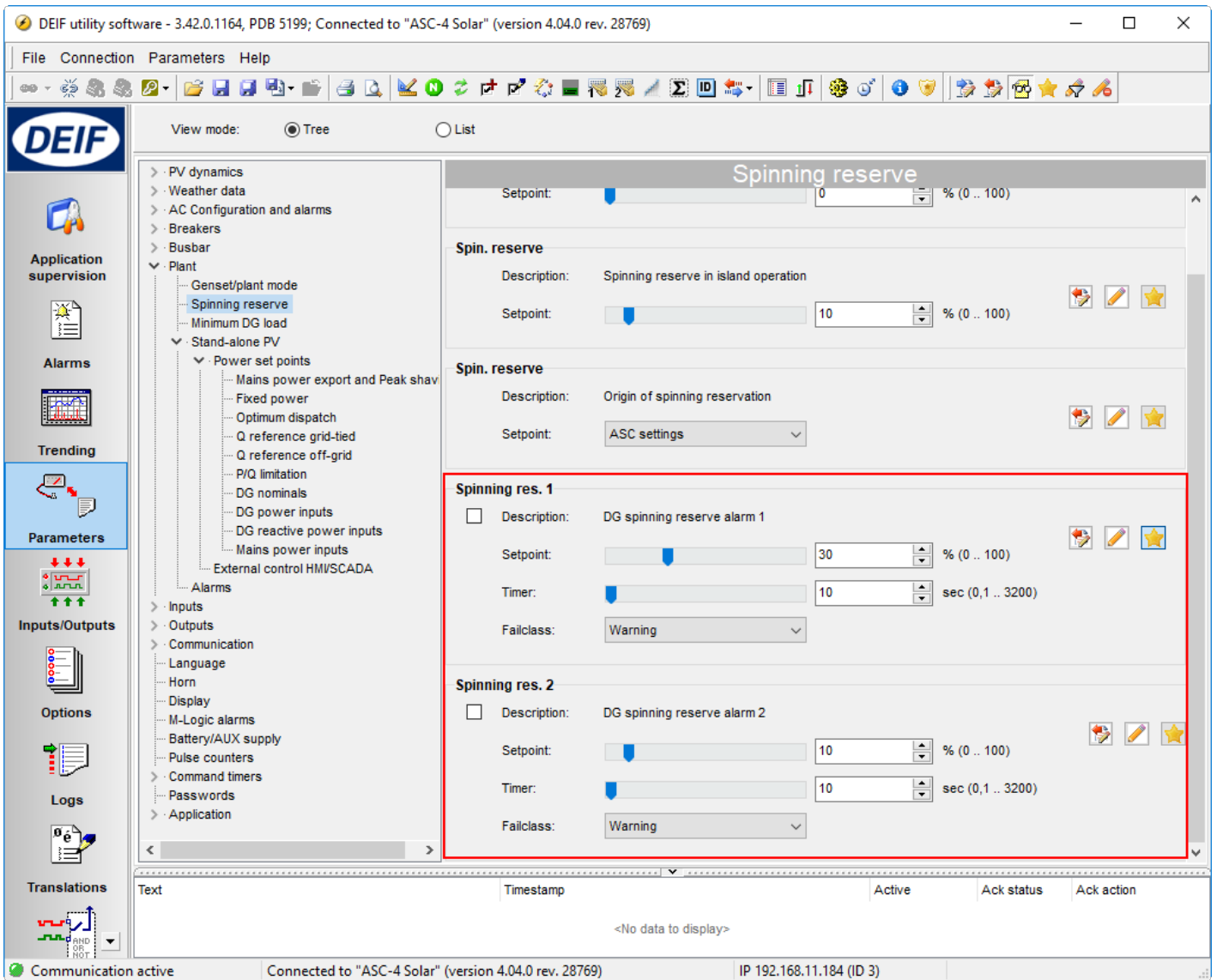

16.2 Dynamic spinning reserve

The DEIF ASC supports the feature “dynamic spinning reserve” in power management systems.

There are two settings, spinning reserve off-grid and grid-tied, and it depends on being grid-tied or not, which one is active.

The screenshot displays the 'Spinning reserve' configuration page. On the left, a navigation tree shows the following structure:

- > PV dynamics
- > Weather data
- > AC Configuration and alarms
- > Breakers
- > Busbar
- ▼ Plant
 - ... Genset/plant mode
 - Spinning reserve**
 - ... Minimum DG load
 - ▼ Stand-alone PV
 - ▼ Power set points
 - ... Mains power export and Peak shaving
 - ... Fixed power
 - ... Optimum dispatch
 - ... Q reference grid-tied
 - ... Q reference off-grid
 - ... P/Q limitation
 - ... DG nominals
 - ... DG power inputs
 - ... DG reactive power inputs
 - ... Mains power inputs

The main configuration area contains three sections, each titled 'Spin. reserve':

- Spin. reserve**
Description: Spinning reserve in mains parallel operation
Setpoint: 0 % (0 .. 100)
- Spin. reserve**
Description: Spinning reserve in island operation
Setpoint: 10 % (0 .. 100)
- Spin. reserve**
Description: Origin of spinning reservation
Setpoint: ASC settings

If adjusted to 10 %, the setting will reserve that on the generators. In this way, the generator plant can always instantly supply the set amount. The setting refers to the actual PV production, hence it is a dynamic spinning reserve because the pv production may vary.

Origin of spinning reserve

Note that the spinning reserve setting can be taken from the ASC, or a PLC can write the data into the ASC. This is adjusted in the last setting, and the default is "ASC settings".

17. Auto start/stop

In order to automatically start and stop the production from the inverters, it is recommended to configure a condition in M-Logic that ensures that the start signal is there while the controller is in full automatic:

If switches, operators, PLC, SCADA or other methods are used, of course this setup is not needed or may vary depending on the requested.

DEIF utility software - 3.42.0.1164, PDB 5199; Connected to "ASC-4 Solar" (version 4.04.0 rev. 28769)

File Connection Parameters Help

DEIF

- Application supervision
- Alarms
- Trending
- Parameters
- Inputs/Outputs
- Options
- Logs
- Translations

Logic 1 Item description (optional and saved in project file only)

NOT <input type="checkbox"/>	Event A: Auto Mode: Modes	Operator: OR	NOT <input type="checkbox"/>	Event B: Not used	Operator: OR	NOT <input type="checkbox"/>	Event C: Not used
------------------------------	---------------------------	--------------	------------------------------	-------------------	--------------	------------------------------	-------------------

Enable this rule Output: Auto start/stop: Command Delay (sec.): 0

Logic 2 Item description (optional and saved in project file only)

NOT <input type="checkbox"/>	Event A: Not used	Operator: OR	NOT <input type="checkbox"/>	Event B: Not used	Operator: OR	NOT <input type="checkbox"/>	Event C: Not used
------------------------------	-------------------	--------------	------------------------------	-------------------	--------------	------------------------------	-------------------

Enable this rule Output: Not used Delay (sec.): 0

Logic 3 Item description (optional and saved in project file only)

NOT <input type="checkbox"/>	Event A: Not used	Operator: OR	NOT <input type="checkbox"/>	Event B: Not used	Operator: OR	NOT <input type="checkbox"/>	Event C: Not used
------------------------------	-------------------	--------------	------------------------------	-------------------	--------------	------------------------------	-------------------

Enable this rule Output: Not used Delay (sec.): 0

Logic 4 Item description (optional and saved in project file only)

NOT <input type="checkbox"/>	Event A: Not used	Operator: OR	NOT <input type="checkbox"/>	Event B: Not used	Operator: OR	NOT <input type="checkbox"/>	Event C: Not used
------------------------------	-------------------	--------------	------------------------------	-------------------	--------------	------------------------------	-------------------

Enable this rule Output: Not used Delay (sec.): 0

Logic 5 Item description (optional and saved in project file only)

NOT <input type="checkbox"/>	Event A: Not used	Operator: OR	NOT <input type="checkbox"/>	Event B: Not used	Operator: OR	NOT <input type="checkbox"/>	Event C: Not used
------------------------------	-------------------	--------------	------------------------------	-------------------	--------------	------------------------------	-------------------

Enable this rule Output: Not used Delay (sec.): 0

Logic 6 Item description (optional and saved in project file only)

NOT <input type="checkbox"/>	Event A: Not used	Operator: OR	NOT <input type="checkbox"/>	Event B: Not used	Operator: OR	NOT <input type="checkbox"/>	Event C: Not used
------------------------------	-------------------	--------------	------------------------------	-------------------	--------------	------------------------------	-------------------

Enable this rule Output: Not used Delay (sec.): 0

Text	Timestamp	Active	Ack status	Ack action
<No data to display>				

Communication active Connected to "ASC-4 Solar" (version 4.04.0 rev. 28769) IP 192.168.11.184 (ID 3)

18. Transducer setup

18.1 Multi-input setup

This applies only to units purchased with the option M4 or G5.

Multi-input 102, 105, 108 are configured to 4-20 mA signals in menus 10980/10990/11000 in the utility SW.

Notice that the 4-20 mA inputs of the option M4 are multi-inputs, and they must be configured correctly in the DEIF Utility SW.

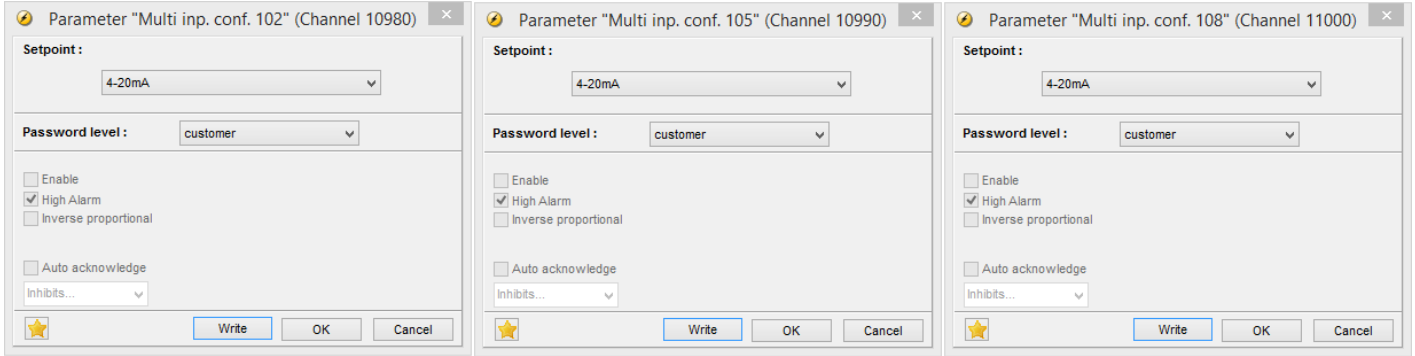

This has to be done as one of the first steps before configuring the transducer inputs.

Normally, these are always kept as 4-20 mA signal inputs.

18.2 Transducer signals

Generator and mains power (active and/or reactive) can be read by the ASC using transducer signals or by using Modbus RS-485. In this chapter, using the transducer method is described.

Eleven transducer inputs may be available namely four inputs on each of M15:6 (91, 93, 95, 97) and M15:8 (127, 129, 131, 133) plus the three signals described below concerning to option M4/G5. (102, 105, 108).

Note that the three inputs should be set to 4-20 mA (assuming your transducers are 4-20 mA) before starting configuring this as described in the section Multi-input setup.

Terminal	Function		Example of associated menus
103	4-20 mA input for mains power	+	4120, mains power 20 mA value 4120, mains power 4 mA value
104		-	
106	4-20 mA input for genset total active power	+	4250, DG power 20 mA value 4250, DG power 4 mA value
107		-	
109	4-20 mA input for genset total reactive power	+	4380, DG reactive power 20 mA value 4380, DG reactive power 4 mA value
110		-	

18.2.1 4 - 20 mA values

It is strictly necessary to adjust the 4-20 mA values of the connected transducer. This is done like the following example for a 4-20 mA mains transducer with the configuration of:

	Power [kW]	Current out [mA]
Power import from grid	700 kW	20 mA
Power export to grid	-700 kW	4 mA

Parameter "4-20mA 102.1" (Channel 4120)

Setpoint : **4 mA value** 0 **20 mA value**
 ... -700 | ... 700

Timer : 120 sec
 0 | 999

Fail class : Warning

Output A : Not used

Output B : Not used

Password level : customer

Enable
 High Alarm
 Inverse proportional
 Auto acknowledge
 Inhibits...

Commissioning
Actual value : 274
Time elapsed : 0 sec (0 %)
0 sec 120 sec

Write OK Cancel

Press the dotted line in front of the value to modify it.

18.2.2 Translation

In the translations page, the multi-inputs can be translated.

Figure 18.1 Display unit translation

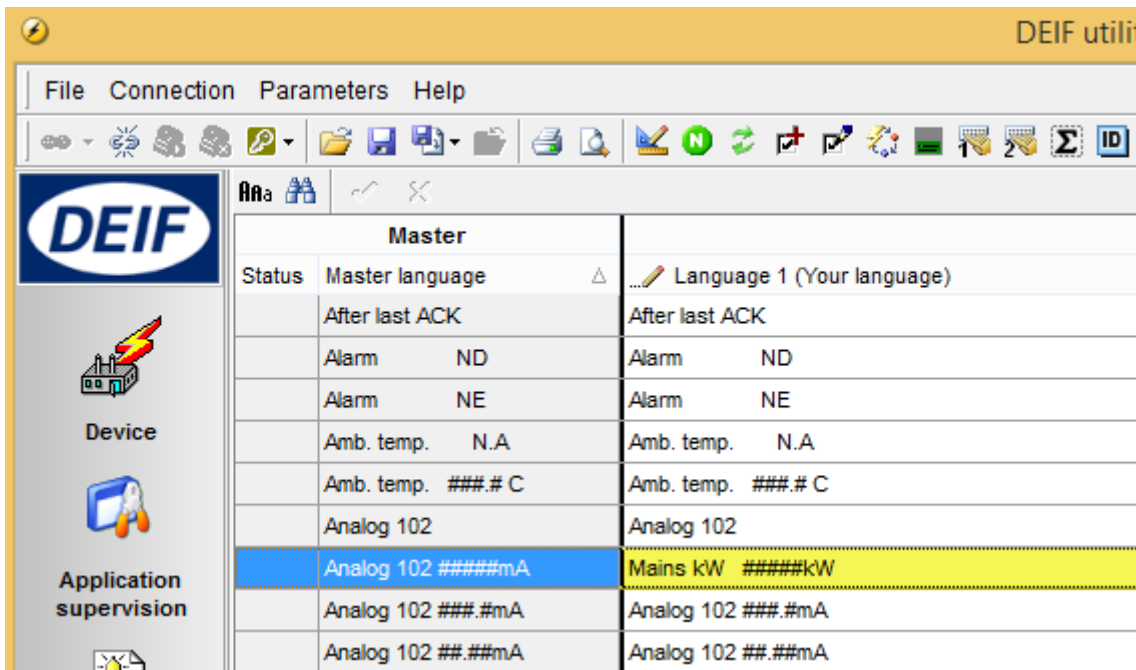
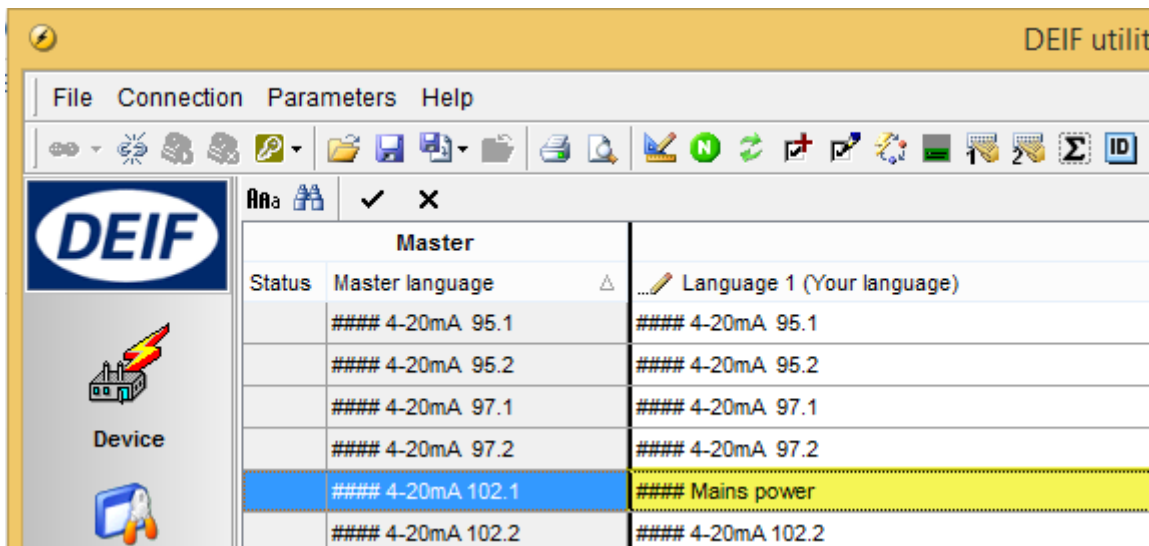

Figure 18.2 Parameter list translation



NOTE #### signifies the live value

18.3 Test procedure for transducer signals

It is essential to test the transducer signals into the DEIF controller. Please follow these steps to verify the good functionality. All 4-20 mA inputs may be used. In the example, the mains power transducer is used (multi-configurable input 102).

Terminal	Designation
102	Not used
103	+ (4 to 20 mA)
104	0 (common)

18.3.1 Mains transducer

Open the MB (Mains Breaker). Now zero amps will flow to or from the mains.

	Power	Current out
MB open position	0 kW	12 mA

Display view (translated example)	Display view (master language)
<div style="border: 1px solid black; padding: 5px;"> PV380.0 380.0 380.0V Mains kW 0kW PROTECTION SETUP PROT CTRL I/O SYST </div>	<div style="border: 1px solid black; padding: 5px;"> PV380.0 380.0 380.0V Analog 102 0mA PROTECTION SETUP PROT CTRL I/O SYST </div>

Close the MB without any generation in the plant. Current will flow into the plant (depending on load demand).

	Power	Current out
MB open position	352 kW	16 mA

Display view (translated example)	Display view (master language)
<div style="border: 1px solid black; padding: 5px;"> PV380.0 380.0 380.0V Mains kW 352kW PROTECTION SETUP PROT CTRL I/O SYST </div>	<div style="border: 1px solid black; padding: 5px;"> PV380.0 380.0 380.0V Analog 102 352mA PROTECTION SETUP PROT CTRL I/O SYST </div>

Synchronise and close the MB when there is generation in the plant. Current will flow out of the plant (depending on load demand).

	Power	Current out
MB open position	-349 kW	8 mA

Display view (translated example)	Display view (master language)
<div style="border: 1px solid black; padding: 5px;"> PV380.0 380.0 380.0V Mains kW -349kW PROTECTION SETUP PROT CTRL I/O SYST </div>	<div style="border: 1px solid black; padding: 5px;"> PV380.0 380.0 380.0V Analog 102 -349mA PROTECTION SETUP PROT CTRL I/O SYST </div>

18.3.2 Transducer testing tables

Fill in the readings of the display/utility SW as the example above shows. This will give a good indication whether the configuration is correct.

Signal [mA]	Display reading		
	Multi-conf. input 102 [kW]	Multi-conf. input 105 [kW]	Multi-conf. input 108 [kW]
4			
5			
6			
7			

Signal [mA]	Display reading		
	Multi-conf. input 102 [kW]	Multi-conf. input 105 [kW]	Multi-conf. input 108 [kW]
8			
9			
10			
11			
12			
13			
14			
15			
16			
17			
18			
19			
20			

19. Appendix A: Modified parameter list

An example of the modified parameter list for the ASC. The parameter list may seem overwhelming when opened but some main groups may be worked on.

As it may be noted, about 35 parameters need to be changed in order to get a functioning system.

Figure 19.1 Example of a stand-alone system modified parameter list for a Solar controller

Drag a column header here to group by that column									
Channel	Text	Value	Unit	Timer	Enabled	Level	Mismatch	FailClass	
2611	P ramp up	5	%/s	N/A	<input type="checkbox"/>	customer		N/A	
2621	P ramp down	5	%/s	N/A	<input type="checkbox"/>	customer		N/A	
3490	Emergency STOP	N/A		0	<input type="checkbox"/>	customer		Shutdown	
4250	4-20mA 105.1	10		5	<input type="checkbox"/>	customer		Warning	
4380	4-20mA 108.1	10		120	<input type="checkbox"/>	customer		Warning	
6002	Nom. P 1	80	kW	N/A	<input type="checkbox"/>	customer		N/A	
6003	Nom. I 1	116	A	N/A	<input type="checkbox"/>	customer		N/A	
6004	Nom. U 1	400	V	N/A	<input type="checkbox"/>	customer		N/A	
6005	Nom. Q 1	80	kvar	N/A	<input type="checkbox"/>	customer		N/A	
6006	Nom. S 1	80	kVA	N/A	<input type="checkbox"/>	customer		N/A	
6041	BA primary U	400	V	N/A	<input type="checkbox"/>	customer		N/A	
6043	BA Primary I	150	A	N/A	<input type="checkbox"/>	customer		N/A	
6044	BA Secondary I	5	A	N/A	<input type="checkbox"/>	customer		N/A	
6051	BB primary U 1	400	V	N/A	<input type="checkbox"/>	customer		N/A	
6053	BB Nominal U 1	400	V	N/A	<input type="checkbox"/>	customer		N/A	
6061	BB primary U 2	400	V	N/A	<input type="checkbox"/>	customer		N/A	
6063	BB Nominal U 2	400	V	N/A	<input type="checkbox"/>	customer		N/A	
6071	Operation mode	0		N/A	<input type="checkbox"/>	customer		N/A	
7331	DG1 nom. power	60	kW	N/A	<input checked="" type="checkbox"/>	customer		N/A	
7333	DG1 P input	5		N/A	<input checked="" type="checkbox"/>	customer		N/A	
7335	DG2 Q input	6		N/A	<input checked="" type="checkbox"/>	customer		N/A	
7512	Ext. Comm.Speed	1		N/A	<input type="checkbox"/>	customer		N/A	
7520	Ext comm. error	N/A		10	<input type="checkbox"/>	customer		Warning	
7561	PV protocol	10		N/A	<input type="checkbox"/>	customer		N/A	
7562	Tx write type	1		N/A	<input type="checkbox"/>	customer		N/A	
7570	PV COMM error	N/A		3	<input checked="" type="checkbox"/>	customer		Warning	
7580	PV Warning	N/A		0	<input checked="" type="checkbox"/>	customer		Warning	
7590	PV Shutdown	N/A		0	<input checked="" type="checkbox"/>	customer		Shutdown	
9030	Scaling	0		N/A	<input type="checkbox"/>	master		N/A	
10980	Multi inp. conf. 102	0		N/A	<input type="checkbox"/>	customer		N/A	
10990	Multi inp. conf. 105	0		N/A	<input type="checkbox"/>	customer		N/A	
11000	Multi inp. conf. 108	0		N/A	<input type="checkbox"/>	customer		N/A	