



Digital Voltage Controller

DVC 550



1. About the Designer's handbook

1.1 Document information	7
1.1.1 Intended users of the Designer's handbook.....	7
1.1.2 List of technical documentation for DVC 550.....	7
1.1.3 Notation and symbols.....	7
1.2 Warnings and safety	8
1.3 Support information	9
1.3.1 Software and hardware versions.....	9
1.3.2 Technical support.....	9
1.4 Legal information	10

2. About the DVC 550

2.1 Product overview	11
2.1.1 Product description.....	11
2.1.2 Applications.....	12
2.1.3 Extended features through AGC.....	13
2.1.4 Terminal description.....	14
2.1.5 Regulation modes.....	14
2.1.6 Operating values.....	15
2.2 Communication and connections	16
2.2.1 Communication and LED overview.....	16
2.2.2 LED indication.....	16
2.3 Running modes	18
2.3.1 Regulation modes.....	18
2.3.2 Regulation mode priority.....	20
2.3.3 AVR regulation mode priority.....	20
2.3.4 Control of modes and information.....	21
2.4 Protections	21
2.4.1 Under-voltage (ANSI 27).....	21
2.4.2 Over-voltage (ANSI 59).....	21
2.4.3 Under-frequency (ANSI 81L).....	22
2.4.4 Over-frequency (ANSI 81H).....	22
2.4.5 Diode faults.....	23
2.4.6 Open diode fault.....	23
2.4.7 Shorted diode fault.....	23
2.4.8 Motor start fault.....	24
2.4.9 Reverse active power (ANSI 32P).....	24
2.4.10 Reverse reactive power (ANSI 32Q).....	25
2.4.11 Loss of sensing.....	25
2.4.12 Short circuit.....	25
2.4.13 Unbalanced voltage.....	26
2.4.14 Unbalanced current.....	26
2.4.15 Battery under voltage (power supply fault).....	27
2.4.16 IGBT fault.....	27
2.4.17 Power bridge overload.....	28
2.4.18 PT100 # Temperature fault.....	28
2.4.19 PTC # Temperature fault.....	29
2.4.20 Wire break : Analogue input AIN #.....	29
2.4.21 Wire break : Analogue output AOOUT #.....	30

2.4.22 Wire break : Digital output.....	30
2.5 Related functions.....	31
3. Get started with DEIF EasyReg Advanced	
3.1 About the utility software.....	32
3.2 Set up.....	32
3.2.1 Download.....	32
3.2.2 Install.....	32
3.2.3 Connect.....	33
3.2.4 Launch.....	33
3.3 Software access levels.....	34
4. DEIF EasyReg Advanced	
4.1 General layout.....	35
4.2 Configuration window.....	37
4.2.1 Generator description.....	37
4.2.2 Wiring.....	37
4.2.3 Limitations.....	38
4.2.4 Protections.....	39
4.2.5 Regulation mode.....	41
4.2.6 PID settings.....	41
4.2.7 Inputs/outputs.....	42
4.2.8 Curves functions.....	42
4.2.9 User PID gain.....	42
4.2.10 Logic/analogic gates.....	43
4.2.11 Synchronization.....	45
4.2.12 Grid code.....	45
4.3 Oscilloscope.....	46
4.3.1 Oscilloscope window.....	46
4.3.2 Curves.....	46
4.3.3 Trigger.....	47
4.3.4 Cursors.....	48
4.3.5 Transient test.....	48
4.3.6 Open a curve or an oscilloscope configuration.....	49
4.3.7 Save a curve or an oscilloscope configuration.....	50
4.3.8 Change the plotting area background.....	50
4.3.9 Zoom feature.....	50
4.4 Monitor.....	51
4.4.1 Monitor window.....	51
4.4.2 Add a display.....	51
4.4.3 Add a curve.....	52
4.4.4 Add a gauge.....	52
4.4.5 Add a capability curve.....	53
4.4.6 Add inputs/outputs.....	53
4.4.7 Add temperatures.....	53
4.4.8 Add synchronisation.....	54
4.4.9 Add AVR status and faults.....	54
4.4.10 Edit mode : Resize or delete panels.....	54
4.4.11 Start or stop monitor.....	55
4.4.12 Save a monitor configuration.....	55

4.4.13 Open a monitor configuration.....	56
4.5 Comparison window.....	56
4.6 Create a PDF report.....	57
4.7 Excel Export.....	57
5. Configure the DVC 550	
5.1 Generator description.....	59
5.2 Wiring.....	60
5.3 Limitations.....	61
5.3.1 Capability curve limitations : Under excitation limitation.....	61
5.3.2 Over excitation limitation.....	62
5.3.3 Stator current limitation.....	63
5.3.4 Generator current limitation.....	63
5.4 Protections.....	64
5.4.1 Protections.....	64
5.4.2 Faults group.....	65
5.5 Regulation mode.....	65
5.5.1 Determination of the regulation mode.....	65
5.5.2 Start-up - Set the ramp.....	66
5.5.3 Voltage regulation.....	66
5.5.4 Volt matching.....	72
5.5.5 Generator power factor.....	72
5.5.6 Generator kVAr.....	74
5.5.7 Grid power factor.....	76
5.5.8 Field current (manual mode).....	79
5.6 PID settings.....	81
5.7 Inputs/outputs.....	82
5.8 Curve functions.....	83
5.9 User PID gain.....	84
5.10 Logic/analogic gates.....	84
5.11 Synchronization.....	87
5.12 Grid code.....	88
5.12.1 Grid code.....	88
5.12.2 Profile monitoring.....	89
5.12.3 I stator Max (stator current monitoring).....	89
5.12.4 Voltage monitoring in PF mode.....	90
5.13 Log event.....	91
5.14 Second Configuration.....	91
6. Configure the DVC 550 with AGC	
6.1 About the DVC 550 with the AGC-4.....	93
6.1.1 Software and hardware versions.....	93
6.1.2 Introduction.....	93
6.1.3 Factory settings.....	94
6.1.4 Communication options.....	94
6.2 Wiring the AGC-4 to the DVC 550.....	95
6.3 Configure the DVC 550.....	97
6.3.1 Connect and launch DEIF EasyReg Advanced.....	97
6.3.2 Generator description.....	98
6.3.3 Wiring.....	99

6.3.4 Start up and tuning in DVC 550.....	100
6.3.5 Configure AGC-4 to DVC 550 communication.....	102
6.3.6 Voltage transformer settings.....	103
6.3.7 Analogue bias connection from AGC-4.....	104
6.4 Generator start up.....	104
6.4.1 Start modes.....	104
6.4.2 Normal start.....	104
6.4.3 Close before excitation (CBE).....	105
6.4.4 Excitation ramp.....	109
6.4.5 Start-on threshold.....	109
6.4.6 Soft-start.....	110
6.4.7 Excitation during CBE.....	112
6.5 Magnetisation or inductive motor starting.....	113
6.5.1 Stator current limitation.....	113
6.5.2 Magnetisation.....	113
6.5.3 Inductive motor starting.....	114
6.6 Operation modes.....	115
6.6.1 U/f variable slope (knee function).....	115
6.6.2 Load acceptance module (LAM).....	117
6.6.3 Soft voltage recovery (SVR).....	119
6.6.4 Droop compensation.....	120
6.7 Genset modes.....	121
6.7.1 Genset modes.....	121
6.7.2 Genset mode : Dry alternator.....	121
6.7.3 Genset mode : Ventilation.....	123
6.8 Protections.....	123
6.8.1 Introduction.....	123
6.8.2 Alarm logging from DVC 550 to AGC-4.....	123
6.9 DVC 550 options.....	125
6.9.1 IN, IN/2, IN/3 or IN/4 sensing.....	125
6.9.2 Negative forcing.....	126
6.9.3 VBus compensation.....	127
6.10 Regulation of DVC 550.....	127
6.10.1 PID settings.....	127
6.10.2 Bias and control.....	128
6.11 AGC-4 and DVC 550 cooperation.....	129
6.11.1 Nominal settings.....	129
6.11.2 Auto-view.....	129
6.11.3 Communication error.....	129
6.11.4 DVC 550 alarms on AGC-4.....	130
6.11.5 DAVR info menu (jump 9090).....	130
6.12 M-Logic related to DVC 550.....	131
6.12.1 M-Logic events, outputs and commands.....	131
6.13 Common DVC 550 settings.....	133
6.13.1 Mixed applications.....	133
6.13.2 Shared parameters.....	134
6.14 Modbus communication.....	135
6.14.1 Modbus communication.....	135

6.14.2 Modbus table.....	136
7. Troubleshooting	
7.1 Preventive maintenance instructions.....	139
7.2 Troubleshooting.....	139
7.3 Replace a faulty DVC 550.....	140
8. End-of-life	
8.1 Disposal of waste electrical and electronic equipment.....	142
9. Glossary	
9.1 Terms and abbreviations.....	143
9.2 Vector permutations.....	144

1. About the Designer's handbook

1.1 Document information

1.1.1 Intended users of the Designer's handbook

The manual is primarily for the person who designs the control system and electrical system where the DVC 550 is installed.

1.1.2 List of technical documentation for DVC 550

Document	Contents
Data sheet	<ul style="list-style-type: none">• System description• Technical specifications• Ordering information
Product sheet	<ul style="list-style-type: none">• Product features• Technical specifications
Installation instructions	<ul style="list-style-type: none">• Mounting• Default wiring
Designer's handbook	<ul style="list-style-type: none">• Hardware characteristics and configuration• System principles



More information

Visit <https://www.deif.com/products/dvc-550#documentation> for free access all the DVC 550 documentation and software updates.

1.1.3 Notation and symbols

Warnings and safety symbols

DANGER!



This highlights a dangerous situation.

If these guidelines are not followed, the situation will result in death, serious personal injury, and equipment damage or destruction.

WARNING



This highlights a potentially dangerous situation.

If these guidelines are not followed, the situation could result in death, serious personal injury, and equipment damage or destruction.

CAUTION



This highlights a low level risk situation.

If these guidelines are not followed, the situation could result in minor or moderate injury.

Notation symbols

NOTICE
This highlights general information.



More information

This highlights where to find more information.

NOTE * This highlights a referenced note.



Example heading

This highlights an example.

Symbols for LED indication

LEDs in this document are noted by the following symbols:

Symbol	Colour	State		Notes
●	Grey	Off	Static	<ul style="list-style-type: none">The LED is not active.The feature or indication is not active.
●	Any	On	Static	The feature or indication is active.
☀	Any	On	Flashing	The feature or indication is active.

1.2 Warnings and safety

General safety guidelines

The DVC 550 may contain unprotected live parts, as well as hot surfaces, during operation.

Unjustified removal of protection devices, incorrect use, faulty installation or inappropriate operation could represent a serious risk to personnel and equipment.

All work relating to transportation, installation, commissioning and maintenance must be performed by experienced, qualified personnel (see IEC 364, CENELEC HD 384 or DIN VDE 0100, as well as national specifications for installation and accident prevention).

In these basic safety instructions, qualified personnel means persons competent to install, mount, commission and operate the product and possessing the relevant qualifications.

Safety guidelines during installation

The installation and cooling of equipment must comply with the specifications in the documentation supplied with the product.

The DVC 550 must be protected against excessive stress. In particular, there must be no damage to parts and/or modification of the clearance between components during transportation and handling.

Avoid touching the electronic components and any live parts.

The DVC 550 contains parts which are sensitive to electrostatic stress and may be easily damaged if handled incorrectly. Electrical components must not be exposed to mechanical damage or destruction.

Safety guidelines during electrical connection

When work is performed on DVC 550s which are powered up, national accident prevention specifications must be respected.

The electrical installation must comply with the relevant specifications (for example conductor cross-sections, protection via fused circuit-breaker, or/and connection of protective conductor).

Instructions for an installation which meets the requirements for electromagnetic compatibility, such as screening, earthing, presence of filters and correct insertion of cables and conductors, are also given in this manual. These instructions must be followed in all cases, even if the AVR carries the CE mark. Adherence to the limits given in the EMC legislation is the responsibility of the manufacturer of the installation or the machine.

For EU application: Instrument transformers shall provide basic insulation according to the requirements of IEC 61869-1, "Instrument transformers – Part 1: General requirements" and IEC 61869-2, "Additional requirements for current transformers"

For US application: Instrument transformers shall provide basic insulation according to the requirements of IEEE C57.13, "Requirements for Instrument Transformers," and IEEE C57.13.2, "Conformance Test Procedure for Instrument Transformers."

Protective earth

For the user's own safety, the DVC 550 must be connected to an approved earth using the earth terminal. All 0 V terminals on the DVC 550 are connected to the earth terminal.

Protection of components

The auxiliary power supply, which sources the product's internal power supplies, is essential for AVR operation. It should be connected permanently and be protected by 1 A slow-blow fuses.

Similarly, both the AC and DC AVR power supplies, which are used to create the field current, should be protected by fast-blow fuses or circuit-breakers.

1.3 Support information

1.3.1 Software and hardware versions

The information in this document corresponds to the following software and hardware versions.

Table 1.1 Supported versions

Item	Details	Version
AGC-4	Supported product	4.75.x or later
DVC 550		Hardware: Rev. A Firmware: 1.1
DEIF EasyReg Advanced	Utility software	1.0.6.x or later

1.3.2 Technical support

Technical documentation

Download free without registration any of the DVC 550 technical documentation from the DEIF website.

<https://www.deif.com/products/dvc-550#documentation>

Service and support

DEIF is committed to being available to our customers and partners 24 hours a day, seven days a week, to guarantee the highest levels of service and support.

<https://www.deif.com/support>

Training

DEIF arranges **training courses** at DEIF offices worldwide.

<https://www.deif.com/training>

Additional service

DEIF offers **service** with design, commissioning, operating and optimisation.

<https://www.deif.com/support/local-office>

1.4 Legal information

Disclaimer

DEIF A/S reserves the right to change any of the contents of this document without prior notice.

The English version of this document always contains the most recent and up-to-date information about the product. DEIF does not take responsibility for the accuracy of translations, and translations might not be updated at the same time as the English document. If there is a discrepancy, the English version prevails.

Third party equipment

DEIF takes no responsibility for the installation or operation of any third party equipment, including the **genset**. Contact the **genset company** if you have any doubt about how to install or operate the genset.

Trademarks

DEIF is a trademark of DEIF A/S.

Windows® and Excel® are a registered trademarks of Microsoft Corporation in the United States and other countries.

All trademarks are the properties of their respective owners.

Copyright

© Copyright DEIF A/S 2019. All rights reserved.

2. About the DVC 550

2.1 Product overview

2.1.1 Product description

The DVC 550 is a digital automatic voltage regulator (AVR) in a compact unit with a set of connectors and a USB port on the front.

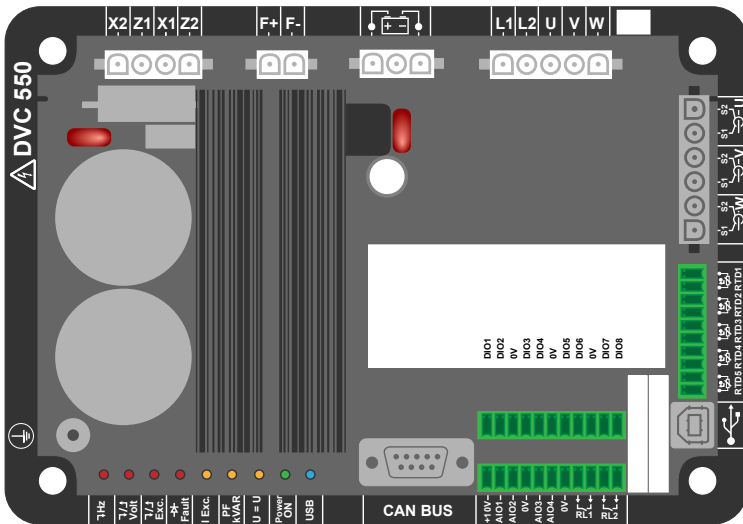

The DVC 550 monitors and regulates the alternator output with rated field current up to 7 A in continuous operation. Up to a maximum 15 A in the event of short-circuit for 10 seconds. These values are given for a temperature of 70 °C.



More information

See the **DVC 550 Data sheet** specification for more information about the full range of values.

It is designed for alternators with SHUNT, AREP (auxiliary winding) or PMG (permanent magnet) excitation types. The DVC adjusts the excitation current in the exciter field according to the desired alternator output. The DVC 550 includes several protections and functions to keep the alternator running in full safe operation.

The utility software, DEIF EasyReg Advanced, provides a visual interface to configure values and parameters. It can also be configured directly with the USB port without external power supply.

The DVC 550 is designed for mounting in a generator terminal box or a control cabinet.

NOTICE

Installation

It must be installed in compliance with local protection and safety standards, especially those specific to electrical installations with a maximum voltage of 300 V AC phase/neutral.

The DVC 550 has several function blocks:

- A power bridge (that supplies a field current)
- A measuring circuit for the various signals such as voltage or current
- A set of digital and analogue I/O: for control of regulation modes, operating information, correcting references
- A set of connectors
- A set of communication modes for dialogue and remote parameter setting

The DVC 550 also features:

- 5 Pt100 or PTC temperature sensors
- 1 CAN BUS connector
- 1 USB connector

2.1.2 Applications

The DVC 550 can be used in applications either with an AGC-4 controller or as a standalone AVR.

When used with an AGC-4 controller, the AGC-4 can control all of the features and receive fault information directly with the CAN bus communication in a similar way to an Engine Control Unit (ECU).

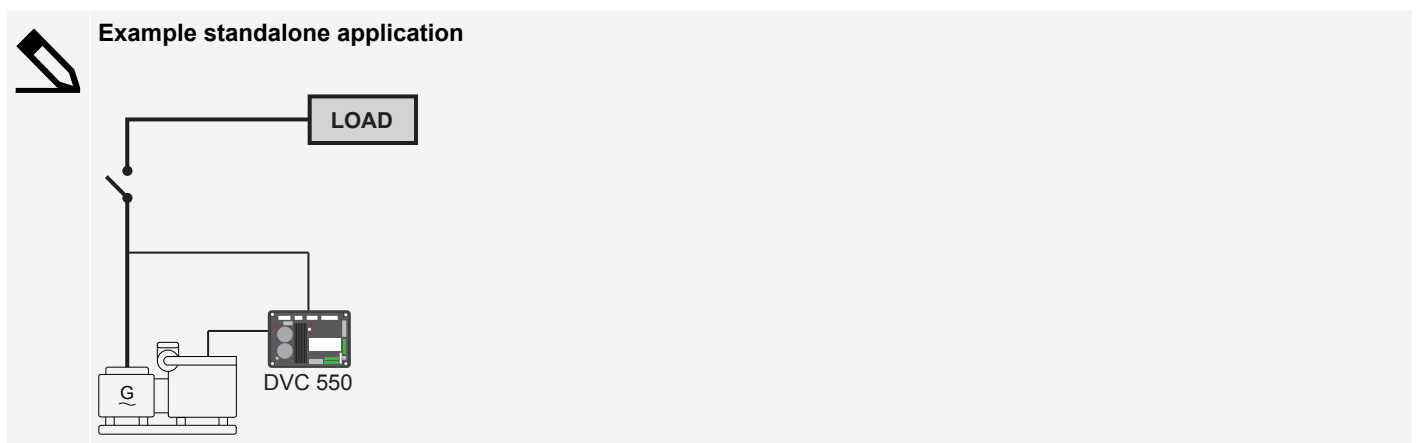
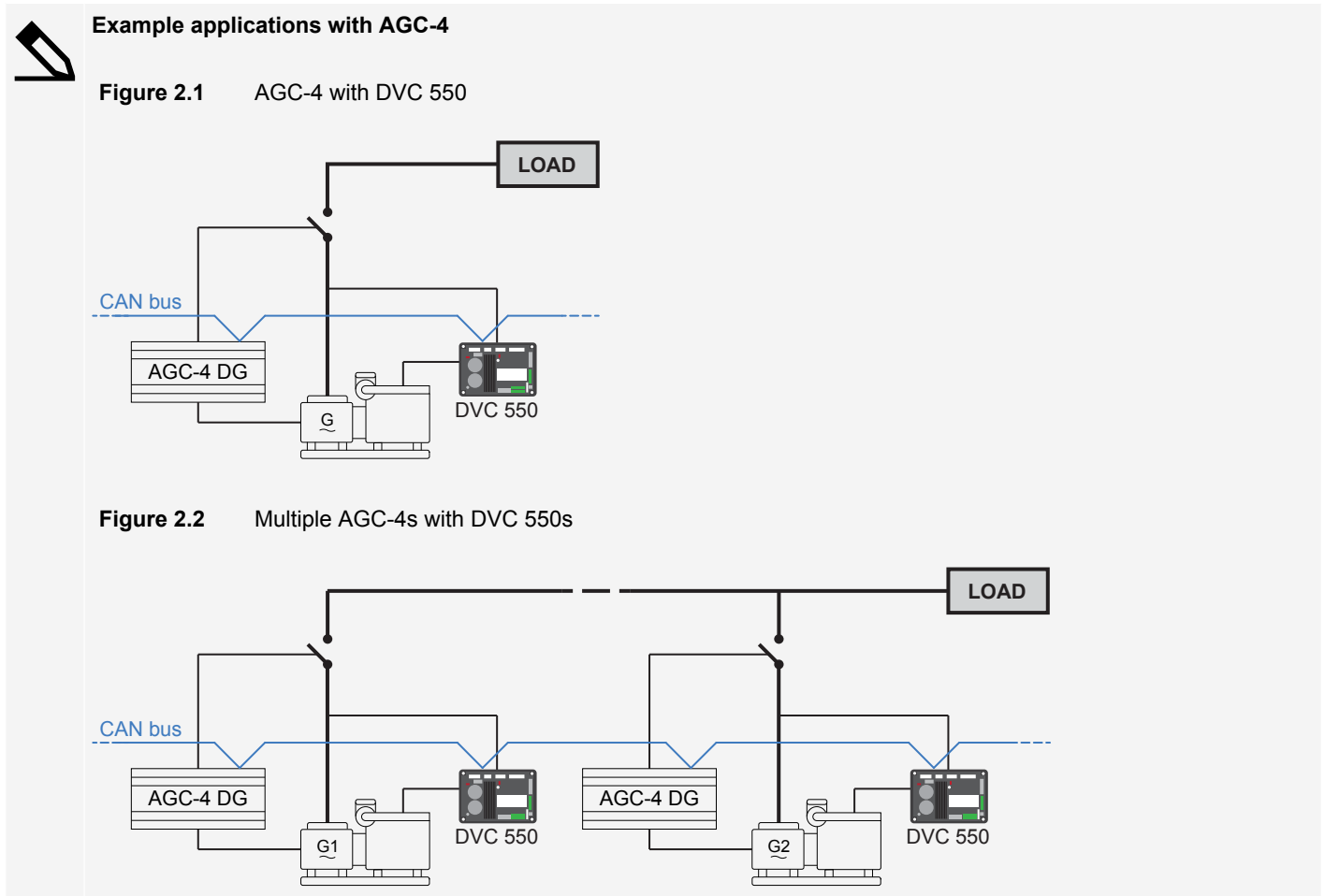

2.1.3 Extended features through AGC

CAN bus

A dedicated J1939 CAN bus connection provides efficient and exclusive communication between the DVC and the controller. This makes it possible to, for example, quickly and easily swap between nominal voltage or frequency settings for a generator.

Start management

Use magnetisation boosting or inductive motor starting to limit the stator current during start-up. This reduces the need to start multiple gensets when connecting a heavy load, and reduces genset over-sizing requirements to a minimum.

Genset ventilation

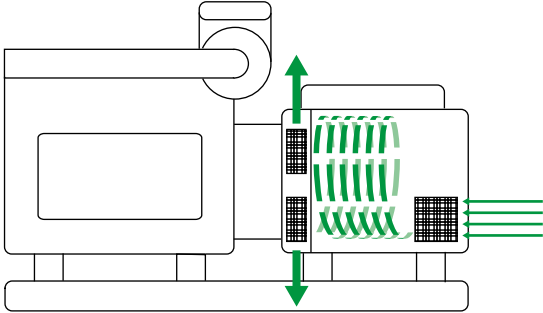

Use the genset ventilation mode to prevent condensation forming on the windings by removing built-up humid air using the alternator fan. Power generation is postponed until the humidity levels are safe.

Genset drying

Condensation on the windings can be removed using the genset drying mode. During drying mode heat generated from a controlled short circuit is used to evaporate condensation on the windings. The genset cannot be connected to the busbar until it is safe to do so.

Run-up synchronisation for critical power applications

Use run-up synchronisation to start multiple gensets at the same time while the gensets are connected to the busbar.

Gridcode compliance

The DVC 550 fast reaction speed complies with European gridcodes. By combining the fast reaction speed with the AGC controller, it is easy to comply with advanced gridcodes (for example, low voltage ride through).

2.1.4 Terminal description

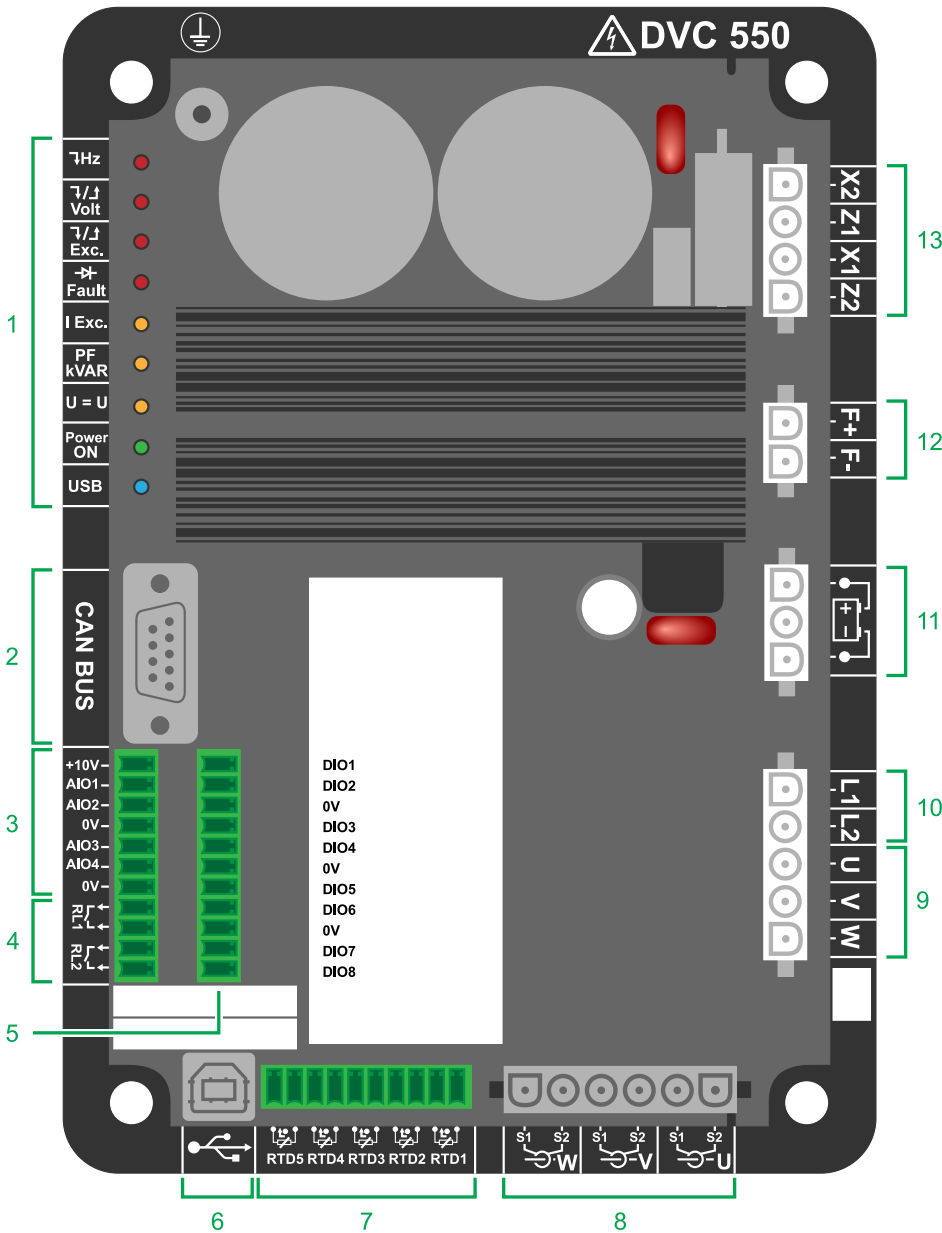

1. LED indication
2. CAN J1939 port
3. Analogue inputs / outputs
4. Relay outputs
5. Digital inputs / outputs
6. USB port
7. Temperature sensors
 - PTC
 - Pt100
8. Current transformer
 - **U**: Used for paralleling and measurement
 - **V** and **W**: Used for measurement only.
9. Voltage sensing
 - Alternator:
 - 1-phase = **V** and **W**
 - 3-phase = **U**, **V**, and **W**
10. Voltage sensing
 - **Mains**: **L1** and **L2**
11. DC supply
 - **DC +** and **DC -**
12. Excitation output:
 - **F + = E +** field winding
 - **F - = E -** fielding winding
13. Field excitation supply
 - **AREP**: X1, Z1, X2, Z2
 - **PMG**: X2, X1, Z2
 - **SHUNT**: X1, X2

2.1.5 Regulation modes

The DVC 550 is a digital voltage regulator used to control the alternator field current using separate control loops. The regulation mode is managed either by parameter-setting, digital inputs, or via the communication mode.

These regulation modes are:

- Voltage regulation
 - With or without quadrature droop to allow parallel machine operation (1F).
 - With or without cross-current compensation.
 - With or without load compensation. *
- Matching of the machine voltage and grid voltage prior to connection to a grid (called **3F** or **U=U**)
- Power factor regulation, only when the alternator is connected to a grid (2F).
- Reactive power (kVAR) regulation, only when the alternator is connected to a grid.
- Regulation of cos phi at the installation delivery point within the drive system capacity, from an analog input (remote measurement mode by a converter supplied by the customer) or by directly calculating the power factor at the delivery point. **

- Regulation of the field current, or manual mode, which allows direct control of the field current value.

NOTE * Quadrature droop, cross-current and load compensation cannot be enabled at the same time and require the use of an optional current transformer.

** Obligation to have the Grid code VTs and Grid code current measurement CT placed at the delivery point and wired on the DVC 550.

The DVC 550 can also be used to:

- Adjust the reference for the regulation mode in progress, using:
 - up/down dry contacts
 - an analogue input (4-20 mA, 0-10 V, ± 10 V, Potentiometer)
- Monitor 5 temperature sensors (Pt100 or PTC)
- Limit the minimum field current delivered to the exciter field
- Limit the maximum stator current
- Detect loss of phase
- Withstand a sudden short-circuit for 10 seconds maximum in AREP, PMG or Shunt
- Protect the alternator in the event of a rotating diode failure
- Monitor (trips) and support electrical networks (Grid Code)
- Monitor signals (event logger)
- Record signals (scope meter feature with the utility SW)

The various faults regulation mode and measurement data items can be delivered to the 8 digital configurable outputs or inputs and 4 analog configurable outputs or inputs (4-20 mA, 0-10 V, ± 10 V).

2.1.6 Operating values

- **Alternator voltage sensing:**
 - 3 phases, 2 phases
 - Two-phase range 0-230 V AC or 0-530 V AC (120 % max. 2 minutes)
 - Consumption < 2 VA
- **Grid code voltage sensing:**
 - 2 phases
 - Two-phase range 0-230 V AC or 0-530 V AC (120 % max. 2 minutes)
 - Consumption < 2 VA
- **Stator current measurement by CT:**
 - 1 or 3 phases
 - Range 0-1 A or 0-5 A (300% max. 30s)
 - Consumption < 2 VA
- **Power supply:**
 - **AC:**
 - 4 terminals for PMG, AREP, SHUNT
 - 2 independent circuits
 - Range 50-277 V AC (115% max. 2 minutes)
 - Max Consumption < 3000 VA
- **Field excitation**
 - Rated 0-7 A
 - Short-circuit 15 A max. at 70°C for 10 seconds
 - Field winding resistance > 4 ohms
- **Auxiliary supply:**
 - Range 8-35 V DC

- Consumption < 1 A
- **Frequency measurement**
 - Range 30-400 Hz
- Regulation accuracy: +/-0.25 % of the average of the three phases on a linear load, with harmonic distortion less than 5%
- Voltage adjustment range: 0 to 150 % of the rated voltage by means of volt-free contacts or an analog input
- Quadrature droop adjustment range: -20 % to 20 %
- Under frequency protection: integrated, adjustable threshold, slope adjustable from $k \times V/Hz$ with $0.5 < k < 5$ in steps of 0.1 V/Hz
- Excitation ceiling: adjustable by a time dependent curve 3 points
- Environment: ambient temperature from -40°C to +70°C, relative humidity of less than 95%, non-condensing, mounted in a cabinet or in a terminal box without excessive vibration
- AVR parameters set using software EasyReg Advance supplied with the product or via communication interfaces

2.2 Communication and connections

2.2.1 Communication and LED overview

Figure 2.3 DVC 550 communication ports and LED indication

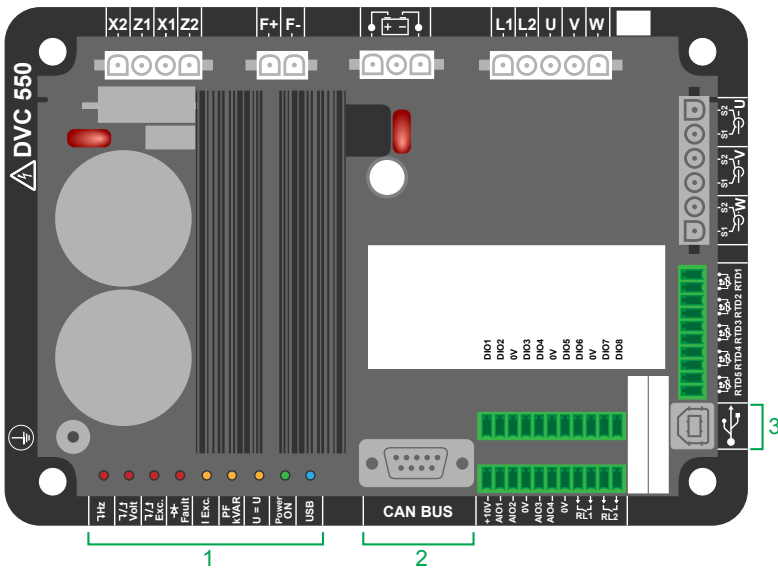

No.	Item	Notes
1	LED indication	Shows operation indication by the different LEDs.
2	CAN bus	CAN bus connection port.
3	USB	USB connection port (Type B).

2.2.2 LED indication

The DVC 550 features LED indication directly on the board.

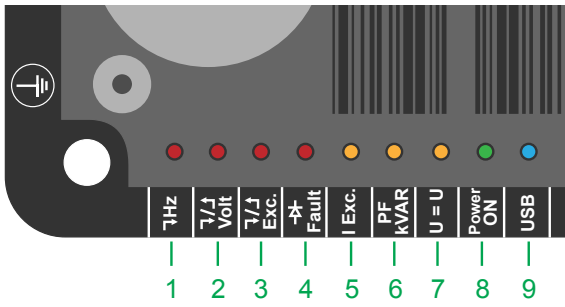

No.	Symbol		LED	Notes
1	↓Hz	Frequency fault	●	Underspeed operation.
2	↑/↓ Volt	Voltage Fault	●	<ul style="list-style-type: none"> Under voltage. Over voltage.
3	↑/↓ Exc.	Excitation Fault	●	Rotor overheating.
			☀	<ul style="list-style-type: none"> Rotor Overload. Under Excitation. Minimum excitation.
4	⚡ Fault	Diode Fault	●	<ul style="list-style-type: none"> Diode Open. Diode in short circuit.
5	I Exc.	I excitation regulation	●	Manual excitation mode
6	PF kVAR	PF or kVAR Regulation	●	<ul style="list-style-type: none"> PF regulation mode kVAR regulation mode
7	U = U	Voltage equalization	●	Voltage equalization mode
8	Power ON	Power ON	●	Regulation in operation
			☀	24 V DC connected but genset stopped.
9	USB	USB	●	USB connected

2.3 Running modes

2.3.1 Regulation modes

The regulation mode to be configured depends on the alternator operation (standalone, parallel between machines, parallel with the grid). Based on these different operating modes, certain regulation modes need to be enabled (some of which are strongly recommended, or even mandatory, and others are only optional).

The following schematics are given for information only, they do not take into account any step-up transformers or voltage sensing transformers. The presence of a transformer for measuring the alternator current is however indicated depending on the regulation mode.



Example 1: Alternator only connected to a load

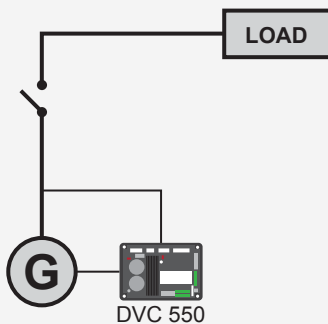

The AVR is operating in voltage regulation mode only.

- There is no need to measure the alternator current.
- No power rating can be indicated.
- Stator current limit, load compensation, or quadrature droop cannot be enabled.

Field current regulation is optional.

- The reference must be permanently set so that it matches the existing load and will not risk any damage to the load or the machine (risk of over-voltage or under-voltage and risk of over excitation).



Example 2: Alternator connected to other alternators and a load

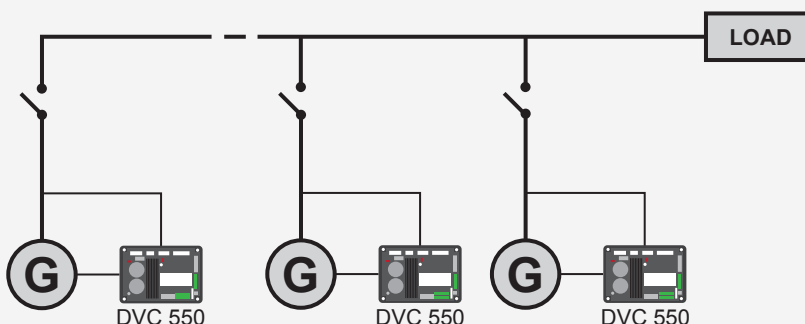

The AVR is operating in voltage regulation mode only.

- To divide the load reactive power equally between all of the running the machines, select one of the following modes:
 1. **Quadrature droop:**
 - Voltage drop according to the percentage of rated reactive load applied to the machine. In this case, alternator current measurement is mandatory on the alternator current measurement input.

2. Cross current:

- Reactive load sharing from a current loop. In this case, a dedicated CT needs to be connected and a current loop needs to be created on the Cross current input.

Field current regulation is optional.

- In this case, the reference must be permanently set so that it matches the existing load and will not risk damaging the load or the machine (risk of over-voltage or under-voltage and over excitation).

NOTE Load compensation cannot be enabled if quadrature droop or cross current is active.



Example 3: The alternator is in parallel with the grid

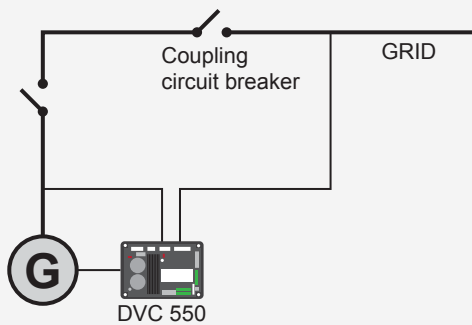

The AVR is operating in voltage regulation mode when the alternator starts.

- Quadrature droop or cross-current correction is not needed, but only if the alternator is connected to the grid.

The voltage match circuit is used to adjust the alternator voltage to the grid voltage prior to connection.

- This can be done automatically by directly measuring the voltage after the coupling circuit breaker, or by changing the alternator reference.

Regulation of the alternator power factor (kVAr), or power factor (PF) at one point of the grid must be enabled once the coupling circuit breaker is closed

- Alternator current measurement is essential in all these regulation scenarios.
- Regulation of the power factor at one point of the grid also requires alternator voltage and current measurements:
 - Measurement of the grid voltage and current at the required point (in this case, the power factor is calculated by the DVC 550).
 - Remote measurement of this power factor through a DVC 550 analogue input or by CAN bus, provided that the delay introduced into the measuring circuit loop is not too long (need to match the delay and the speed of the PID).

Field current regulation is optional.

- In this case, the reference must be permanently set so that it matches the existing load and will not risk damaging the load or the machine.



More information

See **Glossary**, **Vector permutations** for more information about AVR regulation.

NOTICE

Switching regulation mode

Switching from one regulation mode to another is bumpless.

2.3.2 Regulation mode priority

The different regulation modes have a priority order. The order is as follows (highest priority down to lowest priority):

1. Field current
2. If the grid code connection contactor is closed:
 - Grid power factor
 - Alternator kVAr
 - Alternator power factor
3. Voltage matching circuit
4. Voltage

2.3.3 AVR regulation mode priority

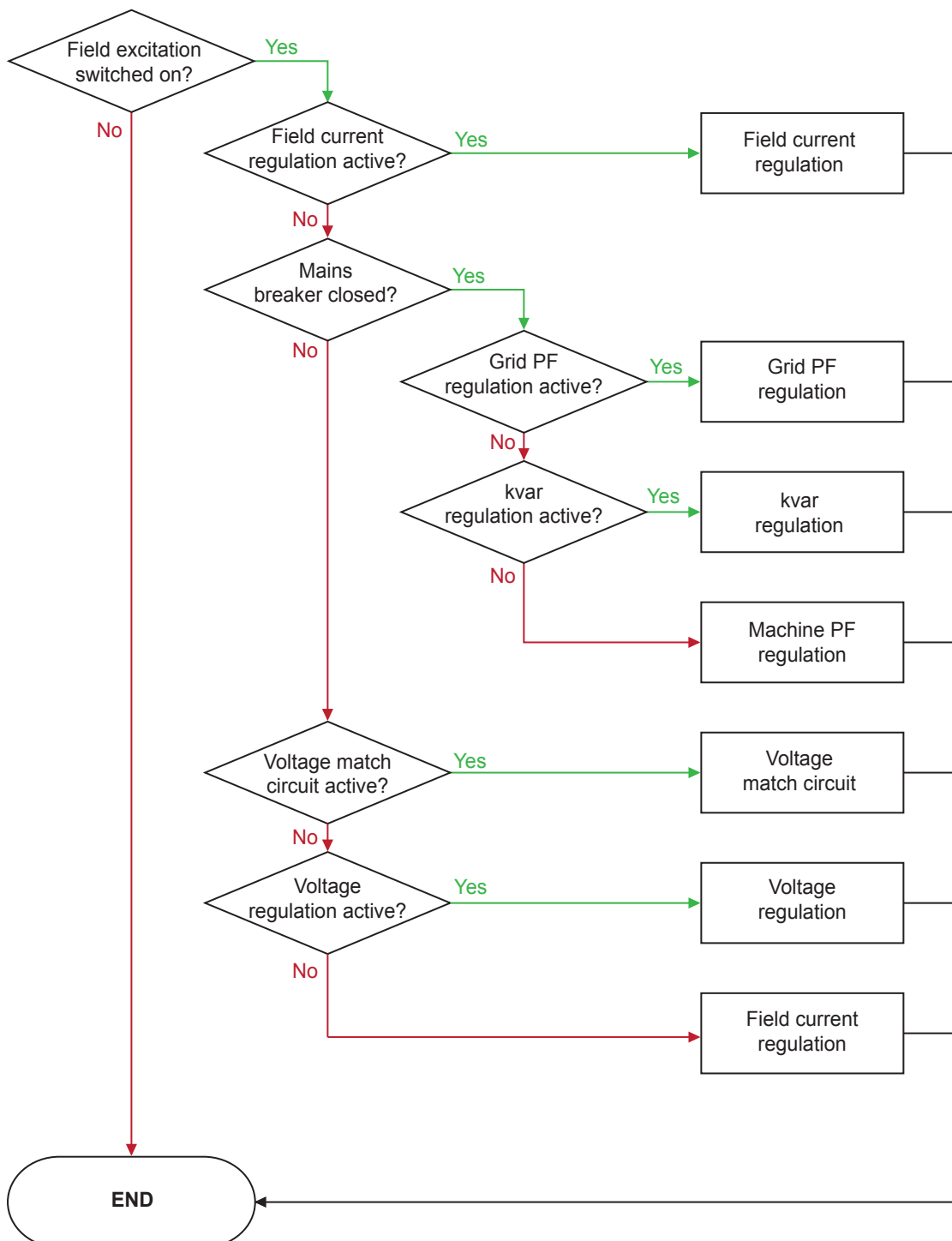

2.3.4 Control of modes and information

Switching from one regulation mode to another, transferring operating modes, and monitoring of alarms or trips can be done by several means: inputs and outputs or communication.

Also, see the schematic for the alternator on which your AVR is installed.

2.4 Protections

2.4.1 Under-voltage (ANSI 27)

Protections / Machine fault

Under-voltage protection is activated if the generator voltage is less than the set point percentage after the time delay ends.

This fault is active only if the regulation is enabled and the soft start ramp achieved.

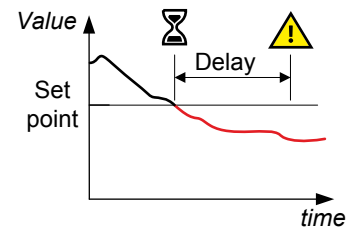

NOTE The set point is a percentage of the actual set point value.

Table 2.1 Default settings

Parameter	Range	Default
Set point	0.00 to 100.00 %	85.00 %
Delay	0.00 s to 3600.00 s	1.00 s
Action	No action, Stop regulation, Shutdown current, Field current before fault	No action
Auto-reset	Not enabled, Enabled	Not enabled
Activation	Not enabled, Enabled	Not enabled

2.4.2 Over-voltage (ANSI 59)

Protections / Machine fault

The **Over-voltage** protection is activated if the generator voltage is higher than the set point percentage after the time delay ends.

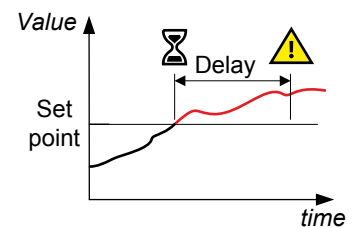

Table 2.2 Default settings

Parameter	Range	Default
Set point	50.00 to 200.00 %	115.00 %
Delay	0.00 s to 3600.00 s	1.00 s

Parameter	Range	Default
Action	No action, Stop regulation, Shutdown current, Field current before fault	No action
Auto-reset	Not enabled, Enabled	Not enabled
Activation	Not enabled, Enabled	Not enabled

2.4.3 Under-frequency (ANSI 81L)

Protections / Machine fault

Under-frequency protection is activated if the generator frequency is less than the set point after the time delay ends.

This protection is also inhibited if the genset is not running.

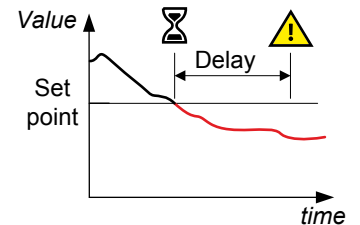

Table 2.3 Default settings

Parameter	Range	Default
Set point	0.00 to 400.00 Hz	47.00 Hz
Delay	0.00 s to 3600.00 s	1.00 s
Action	No action, Stop regulation, Shutdown current, Field current before fault	No action
Auto-reset	Not enabled, Enabled	Not enabled
Activation	Not enabled, Enabled	Not enabled

2.4.4 Over-frequency (ANSI 81H)

Protections / Machine fault

Over-frequency protection is activated if the generator frequency is higher than the set point after the time delay ends.

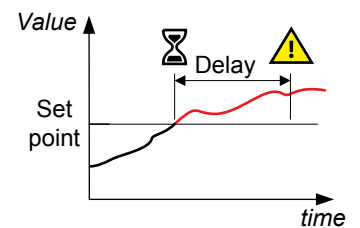

Table 2.4 Default settings

Parameter	Range	Default
Set point	45.00 to 450.00 Hz	53.00 Hz
Delay	0.00 s to 3600.00 s	1.00 s
Action	No action, Stop regulation, Shutdown current, Field current before fault	No action
Auto-reset	Not enabled, Enabled	Not enabled
Activation	Not enabled, Enabled	Not enabled

2.4.5 Diode faults

If the pole ratio (number of exciter poles divided by the number of poles of the generator) is known, the percentage of harmonics supervised by the AVR is the sum of the two harmonics closer of the ratio. For example, for an exciter of 16 poles, and a generator of 6 poles, pole ratio is 2.66, so the percentage of harmonics 2 and 3 are summed.

If the pole ratio is unknown, the percentage of harmonics supervised by the AVR is the sum of all of harmonics.

2.4.6 Open diode fault

Protections / Machine fault

Open diode fault protection is activated if the percentage of field current harmonics is higher than the set point after the time delay ends.

This protection is only active if the regulation is enabled.

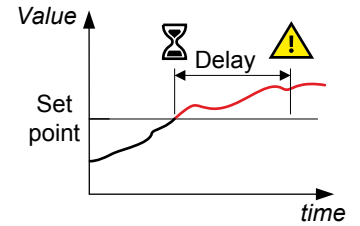

Table 2.5 Default settings

Parameter	Range	Default
Set point	1.00 to 50.00 %	5.00 %
Delay	0.00 s to 3600.00 s	1.00 s
Action	No action, Stop regulation, Shutdown current, Field current before fault	No action
Auto-reset	Not enabled, Enabled	Not enabled
Activation	Not enabled, Enabled	Not enabled

2.4.7 Shorted diode fault

Protections / Machine fault

Shorted diode fault protection is activated if the percentage of the field current harmonics is higher than the set point percentage after the time delay ends.

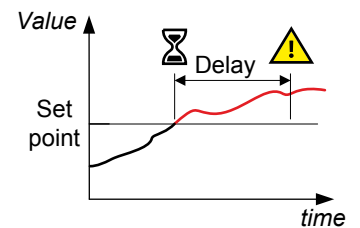

Table 2.6 Default settings

Parameter	Range	Default
Set point	1.00 to 100.00 %	10.00 %
Delay	0.00 s to 3600.00 s	1.00 s
Action	No action, Stop regulation, Shutdown current, Field current before fault	No action

Parameter	Range	Default
Auto-reset	Not enabled, Enabled	Not enabled
Activation	Not enabled, Enabled	Not enabled

2.4.8 Motor start fault

Protections / Machine fault

The **Motor start fault** protection is activated if the generator voltage is less than the rated voltage after the time delay ends.

The timer starts when excitation begins.

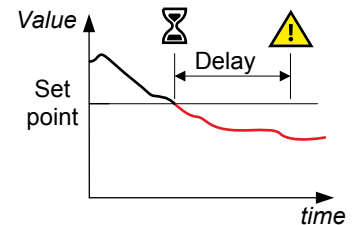

Table 2.7 Default settings

Parameter	Range	Default
Delay	Not configurable	30.00 s
Action	No action, Stop regulation, Shutdown current, Field current before fault	No action
Auto-reset	Not enabled, Enabled	Not enabled
Activation	Not enabled, Enabled	Not enabled

2.4.9 Reverse active power (ANSI 32P)

Protections / Machine fault

The **Reverse active power** protection is activated if the active power threshold as a percentage of the rated active power is less than the set point after the time delay ends.

In this situation the active power is negative and the alternator is in motor mode.

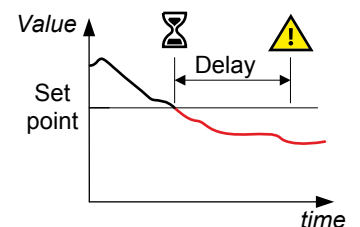

Table 2.8 Default settings

Parameter	Range	Default
Set point	- 100.00 to 0.00 %	-10.00 %
Delay	0.00 s to 3600.00 s	1.00 s
Action	No action, Stop regulation, Shutdown current, Field current before fault	No action
Auto-reset	Not enabled, Enabled	Not enabled
Activation	Not enabled, Enabled	Not enabled

2.4.10 Reverse reactive power (ANSI 32Q)

Protections / Machine fault

The **Reverse reactive power** protection is activated if the reactive power threshold (as a percentage of the rated reactive power) is less than the set point after the time delay ends.

In this situation the reactive power is negative.

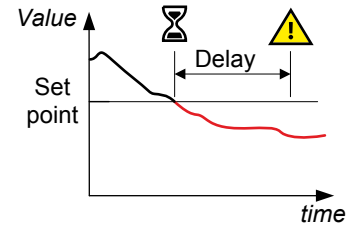

Table 2.9 Default settings

Parameter	Range	Default
Set point	- 100.00 to 0.00 %	-10.00 %
Delay	0.00 s to 3600.00 s	1.00 s
Action	No action, Stop regulation, Shutdown current, Field current before fault	No action
Auto-reset	Not enabled, Enabled	Not enabled
Activation	Not enabled, Enabled	Not enabled

2.4.11 Loss of sensing

Protections / Regulator fault

The **Loss of sensing** protection is activated if the generator voltage is less than the set point percentage after the time delay ends.

This function is deactivated during the short circuit, the soft start and when the voltage is regulated according to the U/f slope.

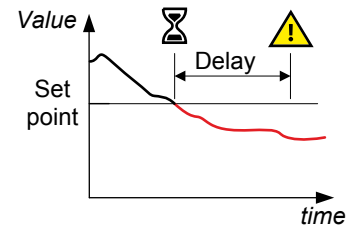

Table 2.10 Default settings

Parameter	Range	Default
Set point	0.00 to 100.00 %	20.00 %
Delay	0.00 s to 3600.00 s	1.00 s
Action	No action, Stop regulation, Shutdown current, Field current before fault	No action
Auto-reset	Not enabled, Enabled	Not enabled
Activation	Not enabled, Enabled	Not enabled

2.4.12 Short circuit

Protections / Regulator fault

The **Short circuit** protection is activated if the generator current measurement is higher than the set point of the rated stator current after the time delay ends.

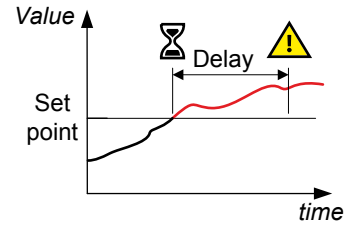

Table 2.11 Default settings

Parameter	Range	Default
Set point	0.00 to 500.00 %	200.00 %
Delay	0.00 s to 3600.00 s	10.00 s
Action	No action, Stop regulation, Shutdown current, Field current before fault	No action
Auto-reset	Not enabled, Enabled	Not enabled
Activation	Not enabled, Enabled	Not enabled

2.4.13 Unbalanced voltage

Protections / Regulator fault

The **Unbalanced voltage** protection is activated if the percentage of unbalance is at least the set point percentage after the time delay ends.

This function is deactivated during the soft start.

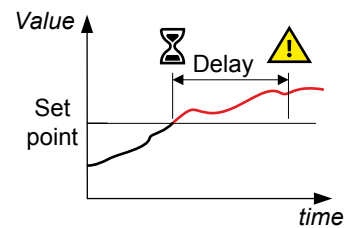

Calculation

Calculation of the voltage unbalance is according to the NEMA standard.

$$\text{Unbalance percentage} = \frac{\text{Maximum generator voltage}}{\text{Average of generator voltage}} \times 100$$

Table 2.12 Default settings

Parameter	Range	Default
Set point	0.00 to 200.00 %	20.00 %
Delay	0.00 s to 3600.00 s	1.00 s
Action	No action, Stop regulation, Shutdown current, Field current before fault	No action
Auto-reset	Not enabled, Enabled	Not enabled
Activation	Not enabled, Enabled	Not enabled

2.4.14 Unbalanced current

Protections / Regulator fault

The **Unbalanced current** protection is activated if the percentage of unbalance is at least the set point percentage after the time delay ends.

This function is deactivated during the soft start.

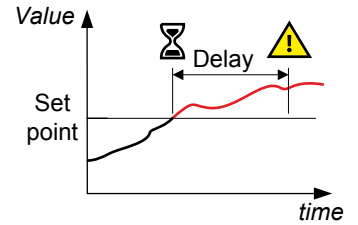

Calculation

Calculation of the voltage unbalance is according to the NEMA standard.

$$\text{Unbalance percentage} = \frac{\text{Maximum generator current}}{\text{Average of generator current}} \times 100$$

Table 2.13 Default settings

Parameter	Range	Default
Set point	0.00 to 200.00 %	20.00 %
Delay	0.00 s to 3600.00 s	1.00 s
Action	No action, Stop regulation, Shutdown current, Field current before fault	No action
Auto-reset	Not enabled, Enabled	Not enabled
Activation	Not enabled, Enabled	Not enabled

2.4.15 Battery under voltage (power supply fault)

Protections / Regulator fault

Battery under voltage protection is activated if the power supply voltage is less than the set point voltage after the time delay ends.

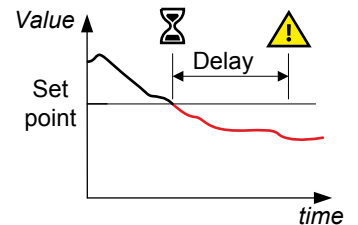

Table 2.14 Default settings

Parameter	Range	Default
Set point	0.00 to 10,000.00 V	10.00 V
Delay	0.00 s to 3600.00 s	10.00 s
Action	No action, Stop regulation, Shutdown current, Field current before fault	No action
Auto-reset	Not enabled, Enabled	Not enabled
Activation	Not enabled, Enabled	Not enabled

2.4.16 IGBT fault

Protections / Regulator fault

The **IGBT fault** protection is activated if there is a coordination fault between the command and action of the power transistors.

NOTICE

Possible degradation of accuracy

If no action is set on this protection then the AVR continues to regulate the set point but with a degradation in accuracy. It is necessary to change the DVC 550 in this situation.

Table 2.15 Default settings

Parameter	Range	Default
Action	No action, Stop regulation, Shutdown current, Field current before fault	No action
Activation	Not enabled, Enabled	Not enabled

2.4.17 Power bridge overload

Protections / Power bridge fault

The **Power bridge overload** protection is activated if the field current is higher than the set point after the time delay ends.

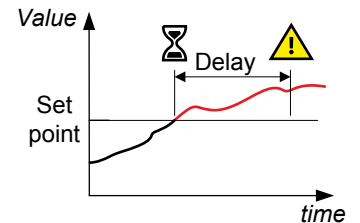

Table 2.16 Default settings

Parameter	Range	Default
Set point	0.00 to 10,000.00 A	15.00 A
Delay	0.00 s to 3600.00 s	10.00 s
Action	No action, Stop regulation, Shutdown current, Field current before fault	Shutdown current
Auto-reset	Not enabled, Enabled	Not enabled
Activation	Not enabled, Enabled	Enabled

2.4.18 PT100 # Temperature fault

Protections / Temperature protections

NOTE There is a PT100 temperature protection for each RTD1, RTD2, RTD3, RTD4, RTD5, and RTD 6. The configuration of each of these protections are the same.

The **Temperature alarm** is activated if the temperature is higher than the alarm set point temperature.

The **Temperature fault** protection is activated if the temperature is higher than the fault set point temperature.

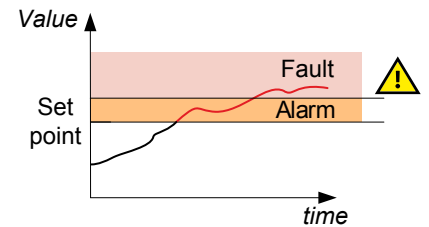

Table 2.17 Default settings

Parameter	Range	Default
Alarm set point	-50.00 to 250.00 °C	155.00 °C
Fault set point	-50.00 to 250.00 °C	165.00 °C
Action	No action, Stop regulation, Shutdown current, Field current before fault	No action
Auto-reset	Not enabled, Enabled	Not enabled
Activation	Not enabled, Enabled	Not enabled

2.4.19 PTC # Temperature fault

Protections / Temperature protections

NOTE There is a PTC temperature protection for each RTD1, RTD2, RTD3, RTD4, RTD5, and RTD 6. The configuration of each of these protections are the same.

The **Temperature fault** protection is activated if the resistance value is higher than the alarm set point.

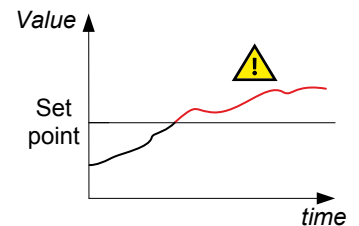

Table 2.18 Default settings

Parameter	Range	Default
1 PTC set point	Not configurable	1.330 Ω
3 PTC (serial) set point	Not configurable	3.990 Ω
Custom set point	0 to 10,000 Ω	-
Action	No action, Stop regulation, Shutdown current, Field current before fault	No action
Auto-reset	Not enabled, Enabled	Not enabled
Activation	Not enabled, Enabled	Not enabled

2.4.20 Wire break : Analogue input AIN

Protections / Inputs/outputs protections

NOTE This fault can only be activated if the input type is either **4-20 mA** or **POT (Potentiometer)**.

The wire break detection is activated if the analogue input is no longer detected.

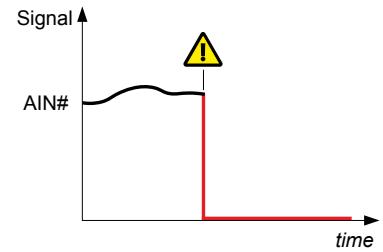

Where # is the number of the input.

You can configure under **Inputs/outputs** if the analogue input value should be maintained during a wire break or not.



More information

See **Inputs/outputs** in **Custom configuration** for more information about how to configure the analogue input to maintain the value during a wire break.

Table 2.19 Default settings

Parameter	Range	Default
Activation	Not enabled, Enabled	Not enabled
Action	No action, Stop regulation, Shutdown current, Field current before fault	No action
Auto-reset	Not enabled, Enabled	Not enabled

2.4.21 Wire break : Analogue output AOUT

Protections / Inputs/outputs protections

The wire break detection is activated if the analogue output is either:

- No longer detected.
- Overload.

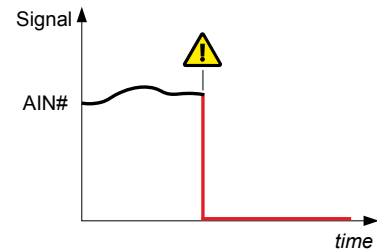

Where # is the number of the output.

Table 2.20 Default settings

Parameter	Range	Default
Activation	Not enabled, Enabled	Not enabled
Action	No action, Stop regulation, Shutdown current, Field current before fault	No action
Auto-reset	Not enabled, Enabled	Not enabled

2.4.22 Wire break : Digital output

Protections / Inputs/outputs protections

The wire break detection is activated if the digital output is in overload after the time delay * ends.

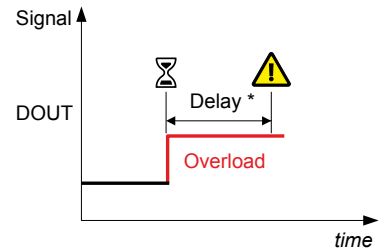

NOTE * The default time delay is 0 seconds which means the fault is activated immediately. You can also specify a time delay in seconds before the protection is activated.

Table 2.21 Default settings

Parameter	Range	Default
Activation	Not enabled, Enabled	Not enabled
Delay	0.00 s to 3,600.00 s	0.00 s
Action	No action, Stop regulation, Shutdown current, Field current before fault	No action
Auto-reset	Not enabled, Enabled	Not enabled

2.5 Related functions

Other DVC 550 functions can be used to record events, supervise the phase synchronizing the alternator with the grid, or create simple control systems or functions for monitoring references.

3. Get started with DEIF EasyReg Advanced

3.1 About the utility software

DEIF EasyReg Advanced is the utility software for the DVC 550.

Easily configure the parameter settings for the alternator, regulation, limits, and protection devices. Access log information and trending data through the utility software.

3.2 Set up

3.2.1 Download

You can download DEIF EasyReg Advanced from the DEIF homepage.

1. Visit: <https://www.deif.com/products/dvc-550#software>
2. Open the section + **General software**.
3. Select the download link.
 - This page shows you the current software version and changelog.
 - You can also access the previous version(s) changelog(s) and license agreement.
4. Submit your email address and then follow the instructions to download the software.

3.2.2 Install

NOTICE

Compatibility

DEIF EasyReg Advanced is compatible with computers running Windows 7 or Windows 10 operating systems.

To install the utility software on your computer:

1. Run the installer as **Administrator** for your computer.

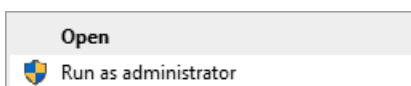

- The software **must** be installed with Administrator rights.
2. Select the installation language.
 3. Select the installation type:
 - **Quick installation**
 - All files and folders are automatically created in the default locations.
 - **Custom installation**
 - You can choose the installation directory.

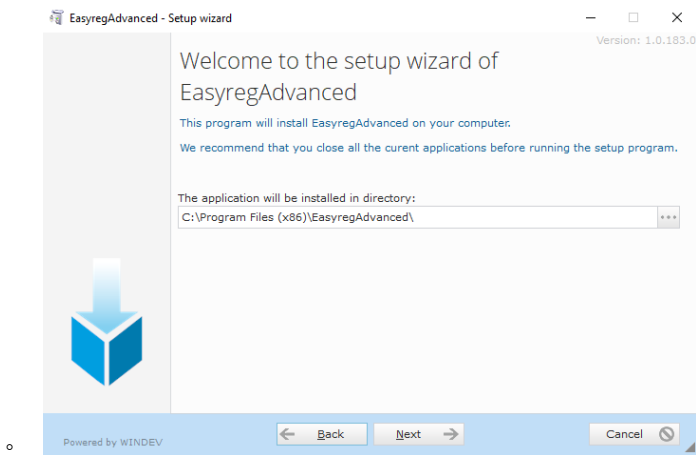

4. A summary is shown when the installation is complete.
 - You can manage the shortcuts created and start the software directly.

3.2.3 Connect

To connect the DVC 550 to your computer you will need a USB Type A to Type B cable.

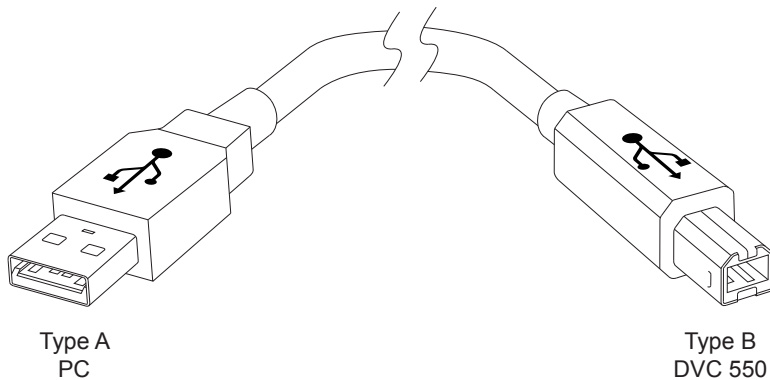

To use the utility software with your DVC 550:

1. Connect the USB cable (shown above) to the DVC 550 and to your computer.
2. Start the DEIF EasyReg Advanced utility software.
3. The utility software attempts to communication with the DVC 550.
4. When communication has been made, this is shown in the bottom left of the software.
 - DVC 550 CONNECTED

3.2.4 Launch

Launch **DEIF EasyReg Advanced** from the installed location.

Example desktop shortcut:

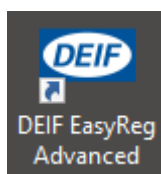

3.3 Software access levels

DEIF EasyReg Advanced has two access levels. When you start the utility software you are prompted to select one of the access levels.

User (standard mode)

For read only access to the parameters and monitoring.

Expert

For full access to the different functions of the regulator and for creating a configuration.

4. DEIF EasyReg Advanced

4.1 General layout

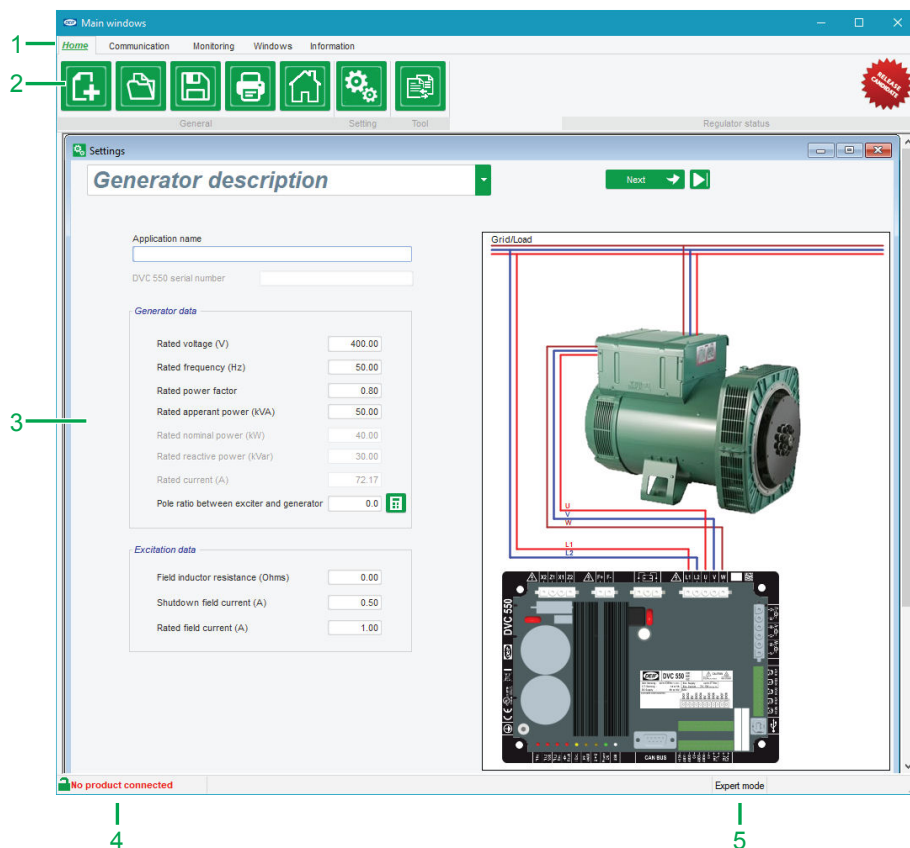

No.	Item	Notes
1	Areas (Tabs)	Shows the different areas available.
2	Options	Shows the options under the area selected.
3	Window	Window for option selected.
4	Connection status	Shows if the DVC 550 is connected to the utility software.
5	Access level (mode)	Shows which access level was selected.

Navigate the different configuration pages

The configuration settings are configured on a number of different pages.

You can use either the *Selection list* or *Navigation options* to move between the different configuration pages.

Figure 4.1 Selection list





Figure 4.2 Navigation options



Additional options

There are additional options that can be used for certain settings.

	Help	Opens help for the setting.
	Calculator	Calculator for setting.
	Direct upload	Uploads the setting to the DVC 550.

NOTE Not all settings have these options available.

About information

Select the **Information** area and then the option **Information**  to display the about information window:

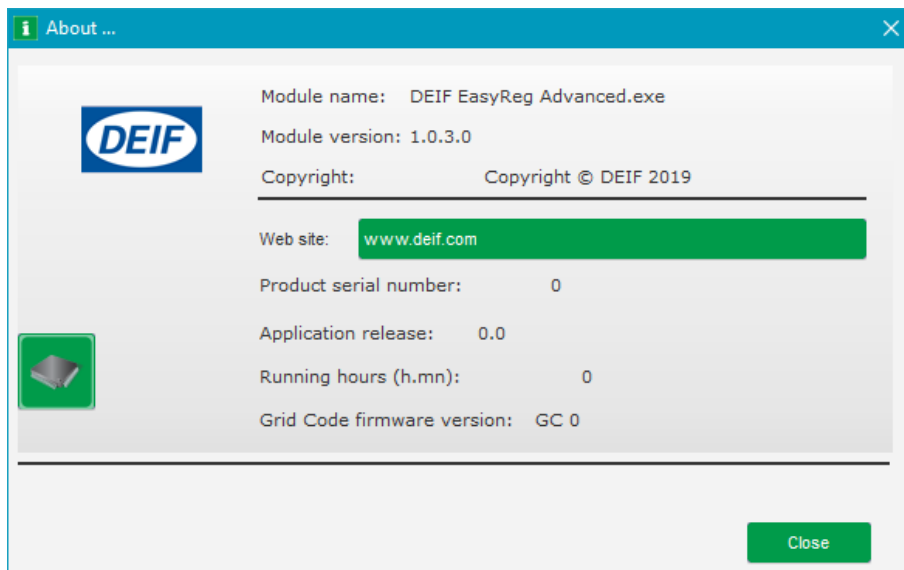

This window features:

- Software version
- Running hours counter in hours and minutes *
- Firmware upgrade

NOTE * This counter is updated every 10 minutes and only when the voltage regulation set point is reached.

To upgrade firmware, select the **Firmware**  option and select a firmware file.

4.2 Configuration window

4.2.1 Generator description

This page configures the alternator and the field excitation settings.

Generator description

Application name:

DVC 550 serial number:

Generator data

Rated voltage (V)	<input type="text" value="400,00"/>
Rated frequency (Hz)	<input type="text" value="50,00"/>
Rated power factor	<input type="text" value="0,80"/>
Rated apparent power (kVA)	<input type="text" value="50,00"/>
Rated nominal power (kW)	<input type="text" value="40,00"/>
Rated reactive power (kVar)	<input type="text" value="30,00"/>
Rated current (A)	<input type="text" value="72,17"/>
Pole ratio between exciter and generator	<input type="text" value="0,0"/>

Excitation data

Field inductor resistance (Ohms)	<input type="text" value="0,00"/>
Shutdown field current (A)	<input type="text" value="0,50"/>
Rated field current (A)	<input type="text" value="1,00"/>

Grid/Load diagram showing a green generator connected to a DVC 550 control board via colored wires (red, blue, green).

4.2.2 Wiring

This page configures the wiring for the measurement inputs (alternator voltage and current).

The preview for the wiring configuration automatically updates when settings are changed.

When the CT only measures part of the generator total current, use the help button to access the advanced CT settings.

Wiring

Generator PT: Generator voltage connection: 2: 3 Ph (U-V-W)

Primary (V): Secondary (V):

Bus voltage PT: Primary (V): Secondary (V):

Step up VT: Primary (V): Secondary (V): Phase shift (°):

CT: CT connection: 0: GEN_UVW

Generator CT	Primary (A): <input type="text" value="1,0"/>	Secondary (A): <input type="text" value="1,0"/>	Phase shift (°): <input type="text" value="0,0"/>
Main CT	Primary (A): <input type="text" value="1,0"/>	Secondary (A): <input type="text" value="1,0"/>	Phase shift (°): <input type="text" value="0,0"/>
Cross current CT	Primary (A): <input type="text" value="1,0"/>	Secondary (A): <input type="text" value="1,0"/>	Phase shift (°): <input type="text" value="0,0"/>

Temperature probe(s)

RTD1 Configuration	RTD4 Configuration
<input type="text" value="0: None"/>	<input type="text" value="0: None"/>
RTD2 Configuration	RTD5 Configuration
<input type="text" value="0: None"/>	<input type="text" value="0: None"/>
RTD3 Configuration	
<input type="text" value="0: None"/>	

Grid/Load diagram showing the generator and control board with additional wiring for measurement inputs (voltage and current).

4.2.3 Limitations

These pages configure the parameter settings for the various machine limits (maximum and minimum field current, stator current limit).

Capability curve limitations

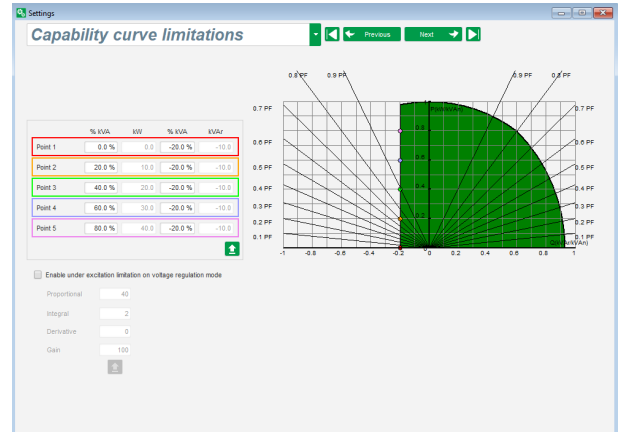

Over excitation limitation

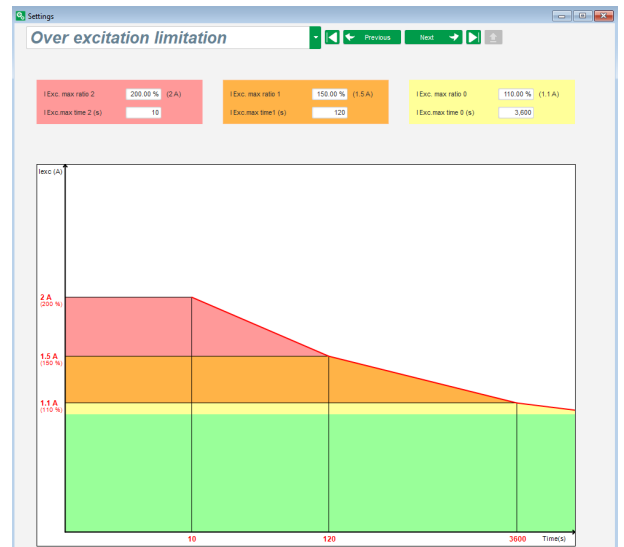

Stator current limitation

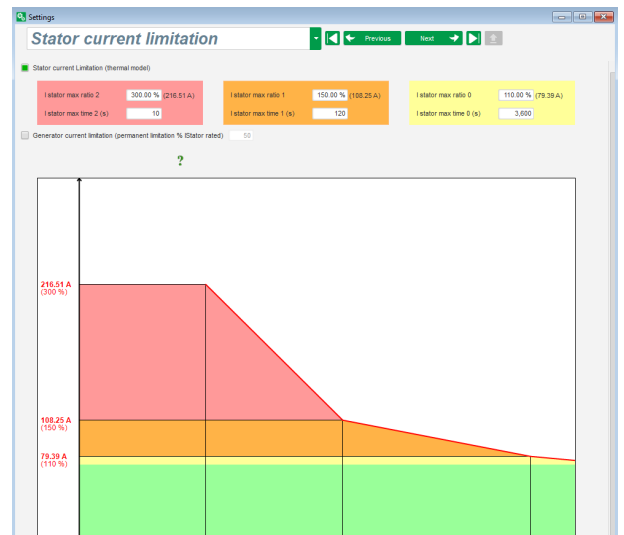

4.2.4 Protections

This page configures the protections provided by the DVC 550.

There are 3 types of protections:

1. Machine faults (generator)
2. Regulator faults
3. Temperature protections

All protections have the same settings:

- An activation of the protection
- A threshold
- A delay
- An action when the delay is over.

The screenshot shows the 'Protections' settings window. It is divided into several sections: 'Machine fault', 'Regulator fault', 'Power bridge', 'Temperature protections', and 'Faults group'. The 'Machine fault' section is currently selected and expanded, showing a list of specific faults with their respective settings. Each fault entry includes an 'Activation' checkbox, a numerical 'setpoint' field (either in % or Hz), an 'Auto-Reset' checkbox, a numerical 'delay (s)' field, and an 'Action after fault' dropdown menu. The faults listed are: Under voltage fault detected (85.00% setpoint, 1.00s delay), Over voltage fault detected (115.00% setpoint, 1.00s delay), Under frequency fault detected (47.00 Hz setpoint, 1.00s delay), Over frequency fault detected (53.00 Hz setpoint, 1.00s delay), Open diode fault detected (5.00% setpoint, 1.00s delay), Shorted diode fault detected (10.00% setpoint, 1.00s delay), Motor start fault detected (30.0s delay), Reverse active power fault detected (-10.00% setpoint, 1.00s delay), and Reverse reactive power fault detected (-10.00% setpoint, 1.00s delay). At the top right of the window, there are navigation buttons for 'Previous', 'Next', and a 'Fault reset' button.

Available actions after fault

- 0: No action
 - The regulation will continue.
- 1: Stop regulation
 - The excitation is then stopped.
- 2: Shutdown current
 - Regulation in field current mode at shutdown value.
- 3: Field current before fault
 - No bump in the regulation.

Auto-reset option

Each protection has an auto-reset option:

- If selected and the fault disappears then regulation will return to the automatic mode (voltage mode, or PF mode, etc.)
- If not selected then the fault action is maintained.

You can group faults in to a fault group:

- Group 1
- Group 2
- Group 3
- Group 4

If any fault is activated in the group, the output for that group is also activated.

You can use the group output state with a digital output or as input on a logical gate.

Fault	Group 1	Group 2	Group 3	Group 4
Overvoltage fault class	<input type="checkbox"/>	<input type="checkbox"/>	<input type="checkbox"/>	<input type="checkbox"/>
Undervoltage fault class	<input type="checkbox"/>	<input type="checkbox"/>	<input type="checkbox"/>	<input type="checkbox"/>
Overfrequency fault class	<input type="checkbox"/>	<input type="checkbox"/>	<input type="checkbox"/>	<input type="checkbox"/>
Underfrequency fault class	<input type="checkbox"/>	<input type="checkbox"/>	<input type="checkbox"/>	<input type="checkbox"/>
Open diode fault class	<input type="checkbox"/>	<input type="checkbox"/>	<input type="checkbox"/>	<input type="checkbox"/>
Shorted diode fault class	<input type="checkbox"/>	<input type="checkbox"/>	<input type="checkbox"/>	<input type="checkbox"/>
Reverse active power fault class	<input type="checkbox"/>	<input type="checkbox"/>	<input type="checkbox"/>	<input type="checkbox"/>
Reverse reactive power fault class	<input type="checkbox"/>	<input type="checkbox"/>	<input type="checkbox"/>	<input type="checkbox"/>
PT100 1 Alarm (Over temp) fault class	<input type="checkbox"/>	<input type="checkbox"/>	<input type="checkbox"/>	<input type="checkbox"/>
PT100 1 fault class	<input type="checkbox"/>	<input type="checkbox"/>	<input type="checkbox"/>	<input type="checkbox"/>
PT100 2 Alarm (Over temp) fault class	<input type="checkbox"/>	<input type="checkbox"/>	<input type="checkbox"/>	<input type="checkbox"/>
PT100 2 fault class	<input type="checkbox"/>	<input type="checkbox"/>	<input type="checkbox"/>	<input type="checkbox"/>
PT100 3 Alarm (Over temp) fault class	<input type="checkbox"/>	<input type="checkbox"/>	<input type="checkbox"/>	<input type="checkbox"/>
PT100 3 fault class	<input type="checkbox"/>	<input type="checkbox"/>	<input type="checkbox"/>	<input type="checkbox"/>
PT100 4 Alarm (Over temp) fault class	<input type="checkbox"/>	<input type="checkbox"/>	<input type="checkbox"/>	<input type="checkbox"/>
PT100 4 fault class	<input type="checkbox"/>	<input type="checkbox"/>	<input type="checkbox"/>	<input type="checkbox"/>
PT100 5 Alarm (Over temp) fault class	<input type="checkbox"/>	<input type="checkbox"/>	<input type="checkbox"/>	<input type="checkbox"/>
PT100 5 fault class	<input type="checkbox"/>	<input type="checkbox"/>	<input type="checkbox"/>	<input type="checkbox"/>
PTC 1 fault class	<input type="checkbox"/>	<input type="checkbox"/>	<input type="checkbox"/>	<input type="checkbox"/>
PTC 2 fault class	<input type="checkbox"/>	<input type="checkbox"/>	<input type="checkbox"/>	<input type="checkbox"/>
PTC 3 fault class	<input type="checkbox"/>	<input type="checkbox"/>	<input type="checkbox"/>	<input type="checkbox"/>
PTC 4 fault class	<input type="checkbox"/>	<input type="checkbox"/>	<input type="checkbox"/>	<input type="checkbox"/>
PTC 5 fault class	<input type="checkbox"/>	<input type="checkbox"/>	<input type="checkbox"/>	<input type="checkbox"/>
Loss of sensing fault class	<input type="checkbox"/>	<input type="checkbox"/>	<input type="checkbox"/>	<input type="checkbox"/>
Unbalance voltage fault class	<input type="checkbox"/>	<input type="checkbox"/>	<input type="checkbox"/>	<input type="checkbox"/>
Unbalance current fault class	<input type="checkbox"/>	<input type="checkbox"/>	<input type="checkbox"/>	<input type="checkbox"/>
Short circuit fault class	<input type="checkbox"/>	<input type="checkbox"/>	<input type="checkbox"/>	<input type="checkbox"/>
IGBT fault class	<input type="checkbox"/>	<input type="checkbox"/>	<input type="checkbox"/>	<input type="checkbox"/>
Motor start fault class	<input type="checkbox"/>	<input type="checkbox"/>	<input type="checkbox"/>	<input type="checkbox"/>
Power bridge overload fault class	<input type="checkbox"/>	<input type="checkbox"/>	<input type="checkbox"/>	<input type="checkbox"/>
Battery under voltage fault class	<input type="checkbox"/>	<input type="checkbox"/>	<input type="checkbox"/>	<input type="checkbox"/>
CAN under voltage fault class	<input type="checkbox"/>	<input type="checkbox"/>	<input type="checkbox"/>	<input type="checkbox"/>

Example Under-voltage protection

Under voltage fault detected

Activation Undervoltage % setpoint (%) Auto-Reset

Undervoltage delay (s) Action after fault

Activate protections are shown in light green.

Under voltage fault detected

Activation Undervoltage % setpoint (%) Auto-Reset

Undervoltage delay (s) Action after fault

In this example, the **Under-voltage** protection is activated if the percentage of under voltage is 85 % or less for at least 1 second.

4.2.5 Regulation mode

This page configures the regulation parameter settings. This includes active regulations, references, and their adjustments.

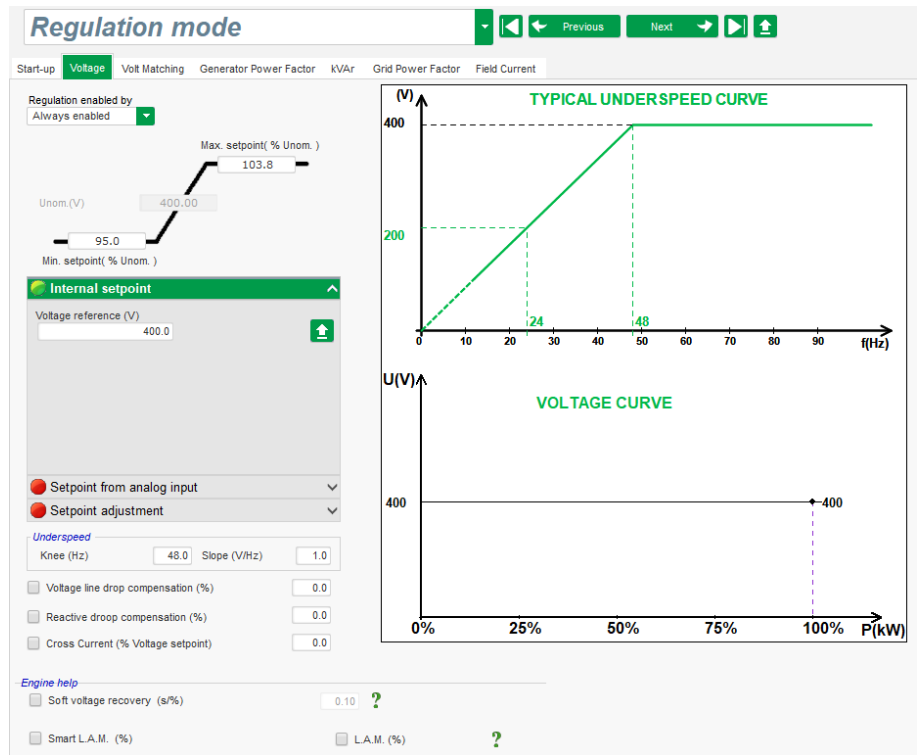

4.2.6 PID settings

This page configures the PID settings.

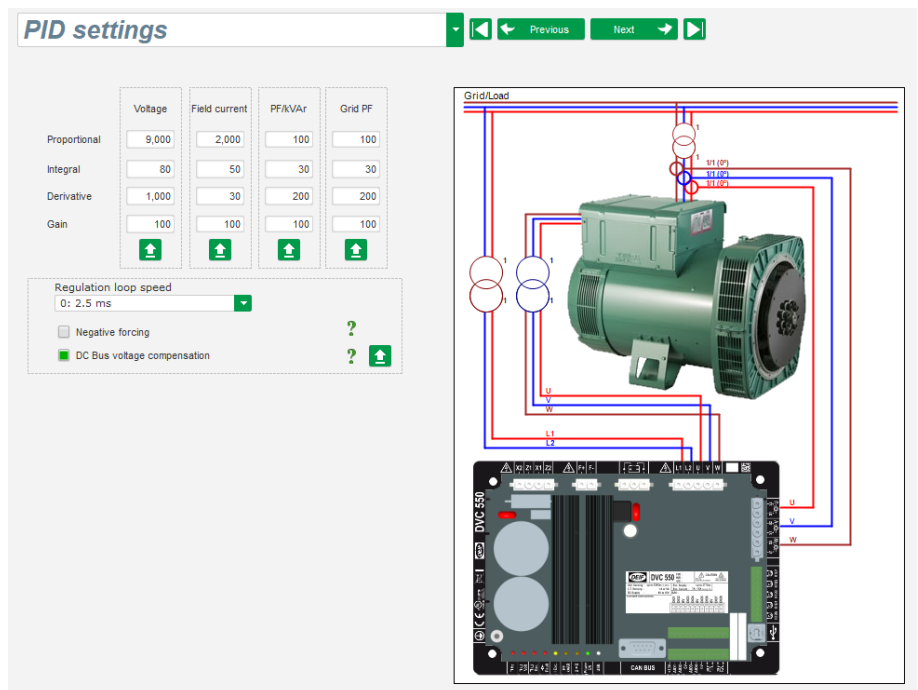

4.2.7 Inputs/outputs

This page configures the digital and analogue input and output parameter settings.

Digital Inputs

Digital Input	Active	Destination
DI1	Active Low	None
DI2	Active Low	None
DI3	Active Low	None
DI4	Active Low	None
DI5	Active Low	None
DI6	Active Low	None
DI7	Active Low	None
DI8	Active Low	None

Digital Outputs

Source	Active	Digital Output
None	Active Low	DO1
None	Active Low	DO2
None	Active Low	DO3
None	Active Low	DO4
None	Active Low	DO5
None	Active Low	DO6
None	Active Low	DO7
None	Active Low	DO8
None	Active Low	DO9
None	Active Low	DO10

Analog Inputs/Outputs

ID	Configuration AI	Destination	0% value	100% value	Source	Configuration AO	0% value	100% value
AI01	0-10V	None	0.00	0.00	None	None	0	0
AI02	0-10V	None	0.00	0.00	None	None	0	0
AI03	0-10V	None	0.00	0.00	None	None	0	0
AI04	0-10V	None	0.00	0.00	None	None	0	0

4.2.8 Curves functions

This page configures the control functions of a parameter as a function of another by plotting 5 points.

Curves Functions

X axis: Generator Average Voltage (Ph-Ph) | Y axis: Reactive power setpoint

Point 1: 384.00 | 1,400.00
 Point 2: 389.00 | 0.00
 Point 3: 400.00 | 0.00
 Point 4: 415.00 | 0.00
 Point 5: 420.00 | -1,400.00

Graph Title: Reactive power setpoint=f(Generator Average Voltage (Ph-Ph))

X axis: None | Y axis: None

Graph Title: None=f(None)

4.2.9 User PID gain

This page configures an independent PID which can be used to regulate another component.

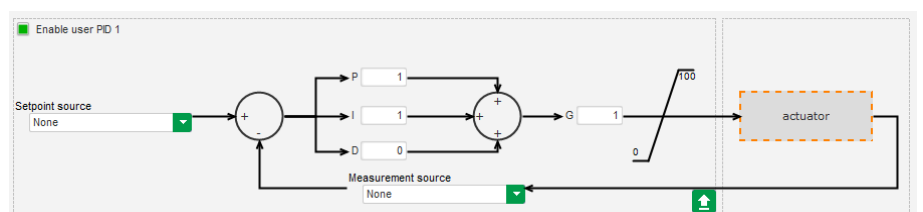

4.2.10 Logic/analogic gates

Create logical functions for simple control with one or two inputs and one configurable output.

A maximum of 20 function gates with 2 inputs each can be used.

Link the functions in sequence and use an output from a previous function as an input condition.

Use your own value variables as gate input conditions in the comparator mode.

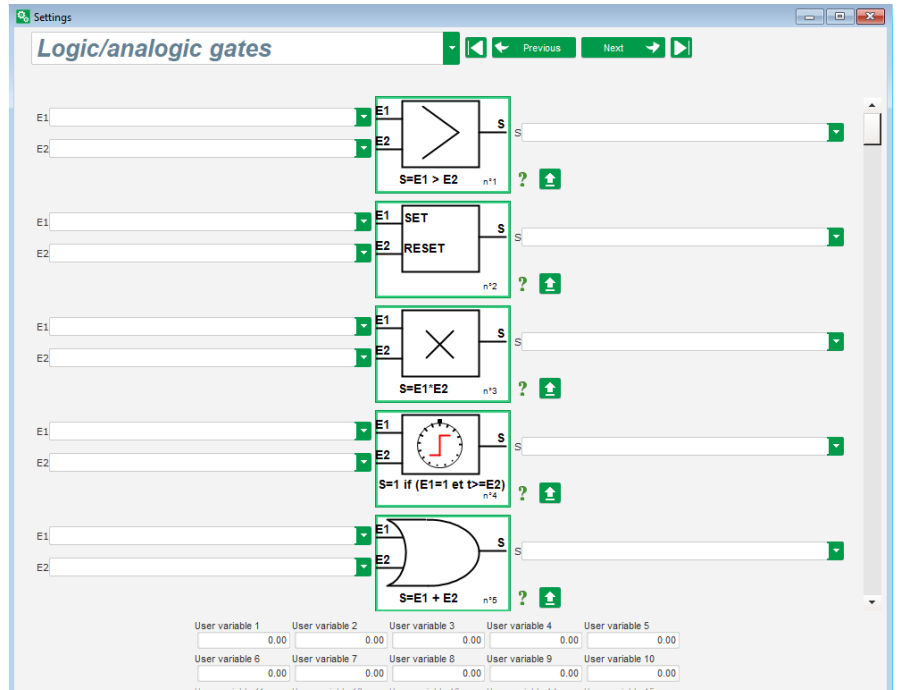

Available logic gate functions

Gate type	Symbol	Parameter type	Truth table															
AND		Binary	<table border="1"> <thead> <tr> <th>E1</th> <th>E2</th> <th>S</th> </tr> </thead> <tbody> <tr><td>0</td><td>0</td><td>0</td></tr> <tr><td>0</td><td>1</td><td>0</td></tr> <tr><td>1</td><td>0</td><td>0</td></tr> <tr><td>1</td><td>1</td><td>1</td></tr> </tbody> </table>	E1	E2	S	0	0	0	0	1	0	1	0	0	1	1	1
E1	E2	S																
0	0	0																
0	1	0																
1	0	0																
1	1	1																
OR		Binary	<table border="1"> <thead> <tr> <th>E1</th> <th>E2</th> <th>S</th> </tr> </thead> <tbody> <tr><td>0</td><td>0</td><td>0</td></tr> <tr><td>0</td><td>1</td><td>1</td></tr> <tr><td>1</td><td>0</td><td>1</td></tr> <tr><td>1</td><td>1</td><td>1</td></tr> </tbody> </table>	E1	E2	S	0	0	0	0	1	1	1	0	1	1	1	1
E1	E2	S																
0	0	0																
0	1	1																
1	0	1																
1	1	1																
Exclusive OR (XOR)		Binary	<table border="1"> <thead> <tr> <th>E1</th> <th>E2</th> <th>S</th> </tr> </thead> <tbody> <tr><td>0</td><td>0</td><td>0</td></tr> <tr><td>0</td><td>1</td><td>1</td></tr> <tr><td>1</td><td>0</td><td>1</td></tr> <tr><td>1</td><td>1</td><td>0</td></tr> </tbody> </table>	E1	E2	S	0	0	0	0	1	1	1	0	1	1	1	0
E1	E2	S																
0	0	0																
0	1	1																
1	0	1																
1	1	0																

Gate type	Symbol	Parameter type	Truth table															
COMPARATOR		Decimal E1 and E2 Binary O	<table border="1"> <tr><td></td><td></td><td>O</td></tr> <tr><td>E1<E2</td><td></td><td>0</td></tr> <tr><td>E1=E2</td><td></td><td>0</td></tr> <tr><td>E1>E2</td><td></td><td>1</td></tr> </table>			O	E1<E2		0	E1=E2		0	E1>E2		1			
		O																
E1<E2		0																
E1=E2		0																
E1>E2		1																
SET-RESET		Binary	<table border="1"> <tr><td>E1</td><td>E2</td><td>S</td></tr> <tr><td>0</td><td>0</td><td>S</td></tr> <tr><td>0</td><td>1</td><td>0</td></tr> <tr><td>1</td><td>0</td><td>1</td></tr> <tr><td>1</td><td>1</td><td>O</td></tr> </table>	E1	E2	S	0	0	S	0	1	0	1	0	1	1	1	O
E1	E2	S																
0	0	S																
0	1	0																
1	0	1																
1	1	O																
SWITCHING		Binary	On the rising edge of I1, S changes state															
COPY		E1 Binary E2 and S Decimal	<table border="1"> <tr><td>E1</td><td>E2</td><td>S</td></tr> <tr><td>0</td><td>0</td><td>0</td></tr> <tr><td>0</td><td>E2</td><td>0</td></tr> <tr><td>1</td><td>E2</td><td>E2</td></tr> </table>	E1	E2	S	0	0	0	0	E2	0	1	E2	E2			
E1	E2	S																
0	0	0																
0	E2	0																
1	E2	E2																
ADDITION		Decimal E1 and E2 S Decimal	$S = E1 + E2$															
SUBSTRACTION		Decimal E1 and E2 S Decimal	$S = E1 - E2$															
MULTIPLICATION		Decimal E1 and E2 S Decimal	$S = E1 \times E2$															
DIVISION		Decimal E1 and E2 S Decimal	$S = E1 / E2$ S value is not changed if E2 is null															

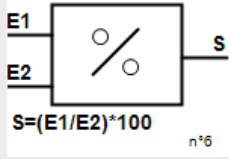
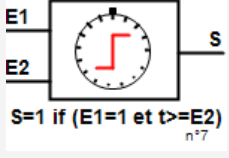
Gate type	Symbol	Parameter type	Truth table
PERCENTAGE		Decimal E1 and E2 S Decimal	$S = (E1/E2) * 100$
TEMPORIZATION		E1 Binary E2 decimal (in seconds) S Binary	S=1 if (E1=1 and $t \geq E2$) S=0 if E1=0 or $t < E2$

4.2.11 Synchronization

This page configures the parameters for the synchronization between the alternator and the grid.

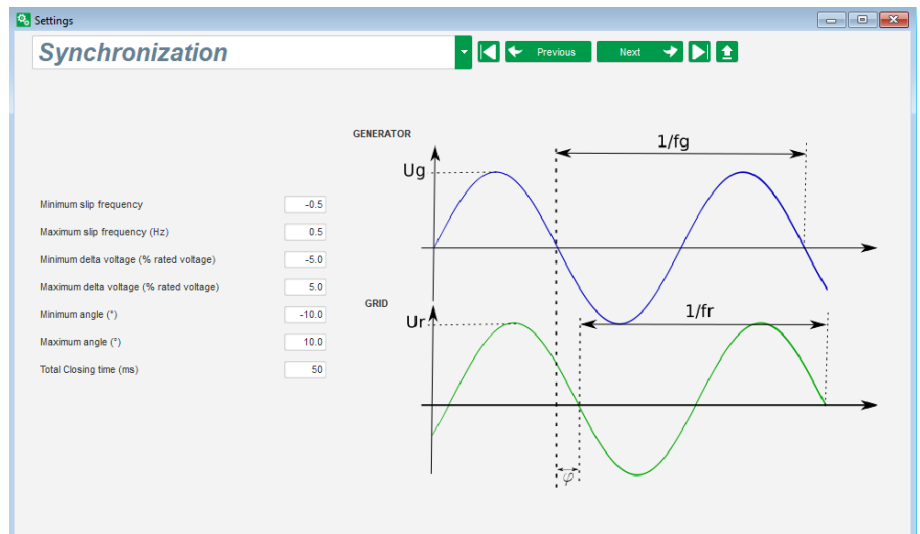

4.2.12 Grid code

The grid code function provides one or more protection faults to be detected could come from the grid. For example, LVRT events (Low Voltage Ride Through) or FRT events (Fault Ride Through), which can damage the generator.

The DVC 550 has the functions:

- Voltage measurement monitoring for grid code fault
- Grid code profile monitoring
- Maximum stator current monitoring

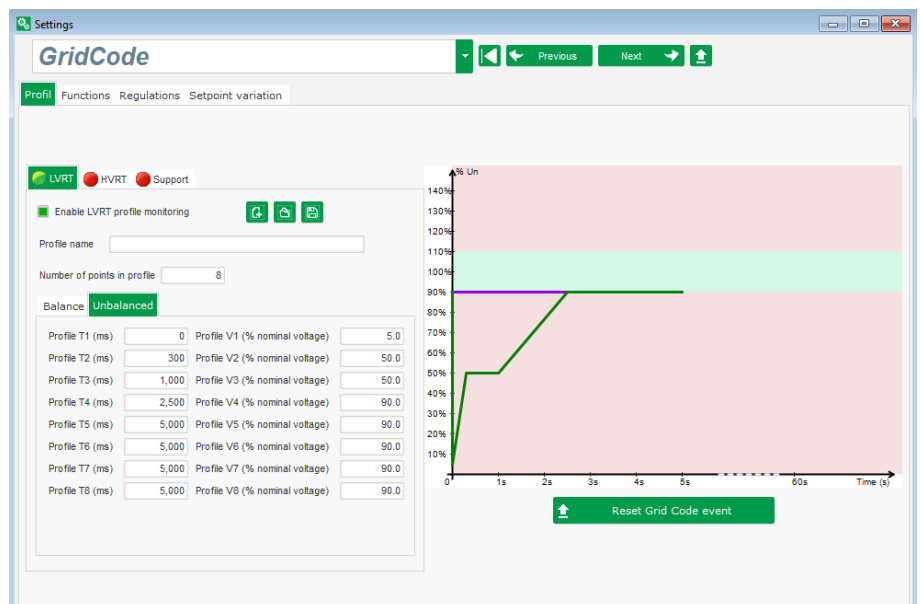

You can also save parameter values, for example generator voltage measurement, generator current measurement or internal angles.

4.3 Oscilloscope

4.3.1 Oscilloscope window

This window is used to trace the evolution of the measured values of up to 8 parameters simultaneously.

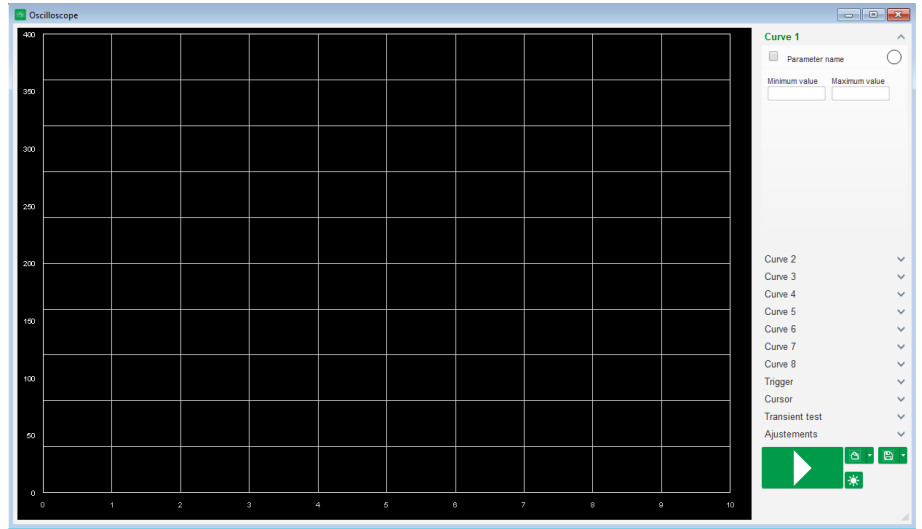

4.3.2 Curves

Each curve is set by:

- Parameter name
- Minimum value
- Maximum value
- Colour

It has its own axis, which is the same colour as the curve.

Select the coloured circle to change the colour.

Select a predefined colour or create your own colour under **Other colors**.

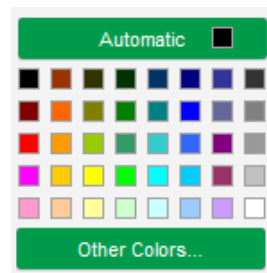
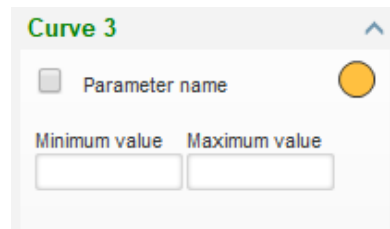

Select **Parameter name** to add or change a parameter.

Select the parameter from the drop-down list.

This parameter can be an analogue or digital value (regulation mode for example).

Select **OK** to use the parameter.

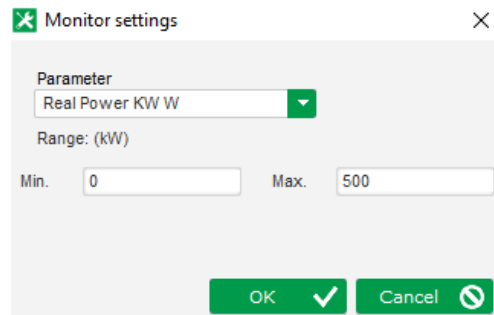

You can refine the minimum and maximum values if necessary.

Changes to these values are applied automatically to the curve shown.

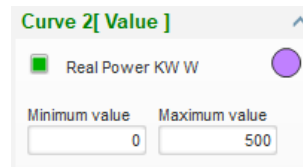

When the monitor is on, the current value appears in square brackets.

4.3.3 Trigger

The trigger is used to launch oscilloscope operation once the chosen parameter value exceeds the value entered either upwards (arrow facing up) or downwards (arrow facing down).

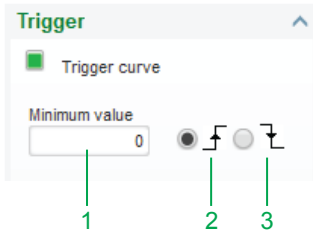

No.	Notes
1	Trigger value.
2	Rising edge.
3	Falling edge.

Select **Trigger** and select the curve.

- Enter the threshold value to be exceeded.
- Choose the overshoot direction (up or down).
- To launch the trigger, select **GO**.
- To cancel the trigger, deselect the curve.

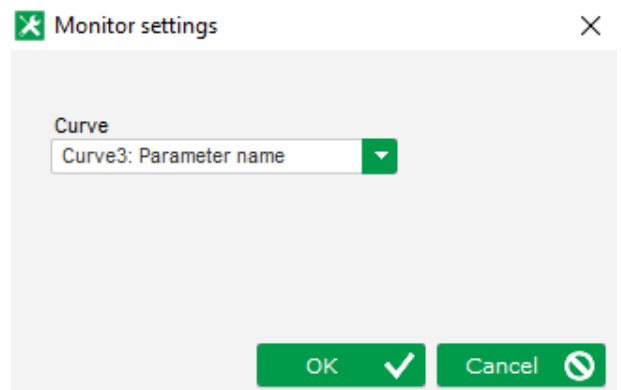

4.3.4 Cursors

Two cursors are available for browsing the curves.

The difference between the two values of Y (curve value) is displayed in **Delta Y** for each curve and **Delta X** (time in seconds) for the time between the two cursors.

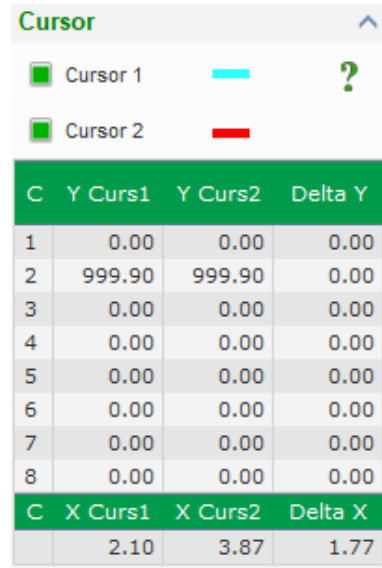

Cursor					
<input checked="" type="checkbox"/>	Cursor 1	—	?		
<input checked="" type="checkbox"/>	Cursor 2	—			
C	Y	Curs1	Y	Curs2	Delta Y
1		0.00		0.00	0.00
2		999.90		999.90	0.00
3		0.00		0.00	0.00
4		0.00		0.00	0.00
5		0.00		0.00	0.00
6		0.00		0.00	0.00
7		0.00		0.00	0.00
8		0.00		0.00	0.00
C	X	Curs1	X	Curs2	Delta X
		2.10		3.87	1.77

4.3.5 Transient test

The transient test is used to check the PID response when changing the reference of current regulation mode.

It has 5 steps, each one can take a different reference value.

The PID parameters can be changed directly when the command is sent.

Select **Start a transient test** to configure the options:

- Select between 1 and 5 steps by selecting on the corresponding tick box.
- For each selected step, define the reference value.
- Define the step time between each step.

The PID values can be changed in order to adjust the gains.

Select **Run** to start the test.

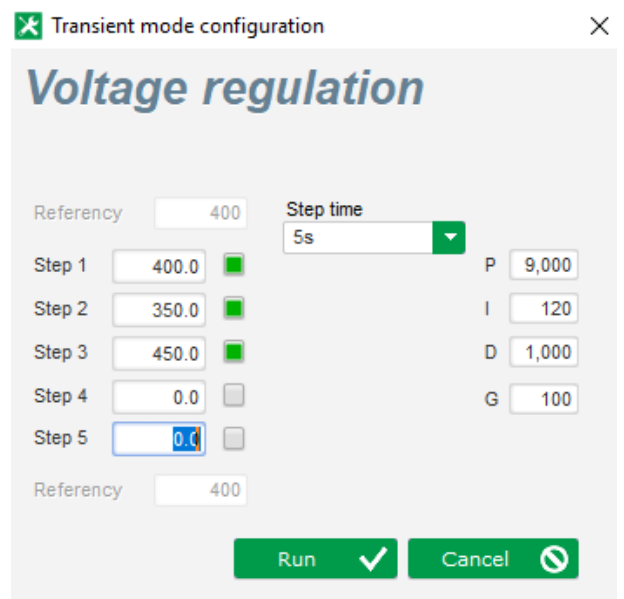

Transient mode configuration

Voltage regulation

Referency: 400 Step time: 5s

Step 1	<input type="text" value="400.0"/>	<input checked="" type="checkbox"/>	P	<input type="text" value="9,000"/>
Step 2	<input type="text" value="350.0"/>	<input checked="" type="checkbox"/>	I	<input type="text" value="120"/>
Step 3	<input type="text" value="450.0"/>	<input checked="" type="checkbox"/>	D	<input type="text" value="1,000"/>
Step 4	<input type="text" value="0.0"/>	<input type="checkbox"/>	G	<input type="text" value="100"/>
Step 5	<input type="text" value="0.0"/>	<input type="checkbox"/>		

Referency: 400

Steps in progress are shown by the reference turning green.

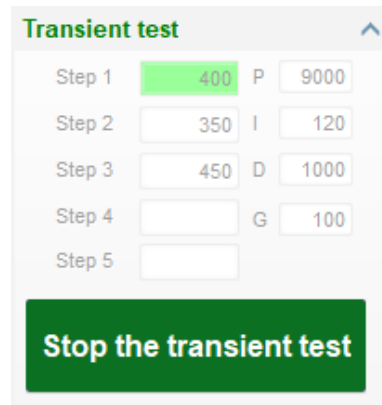

The image shows a control panel titled "Transient test" with a list of five steps. Step 1 is highlighted in green and has a value of 400. Step 2 has a value of 350. Step 3 has a value of 450. Step 4 and Step 5 are empty. To the right of each step are input fields for parameters: P (9000), I (120), D (1000), G (100). At the bottom of the panel is a large green button labeled "Stop the transient test".

This test can be stopped at any time by selecting **Stop the transient test**. The display then reverts to the original reference.

Transient tests cannot be performed if the control reference input is controlled by an analogue input, as this control mode has priority.

During this transient test, the defined minimum and maximum upper and lower limits are not exceeded.

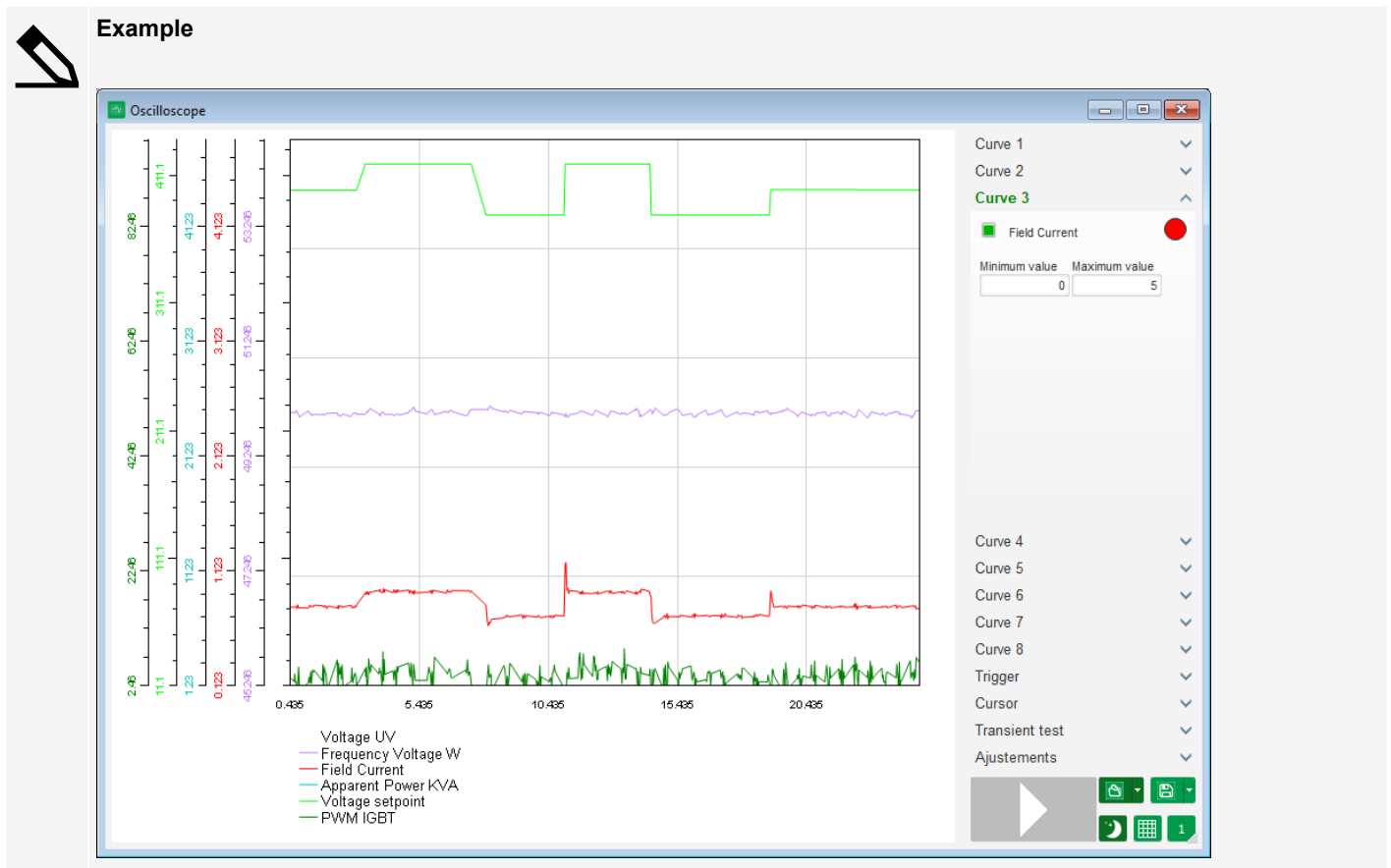

4.3.6 Open a curve or an oscilloscope configuration

Only files created with DEIF EasyReg Advanced can be opened.

Select the **Open** down arrow at the bottom right to open either a configuration or a curves file.

When a curve file is opened, the curve configuration in progress is replaced by the saved curve configuration.

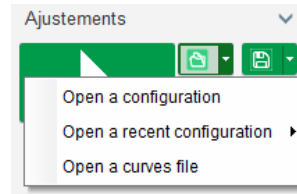

4.3.7 Save a curve or an oscilloscope configuration

Select the **Savedown** arrow at the bottom right to:

- Save the curves file
- Save the configuration
- Print screen

save either a configuration or a curves file.

Print screen allows you to save an image of the oscilloscope.

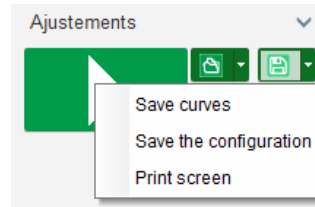

4.3.8 Change the plotting area background

You can change the oscilloscope background colour.

Select **Light**  for a white background.

Select **Dark**  for a black background.

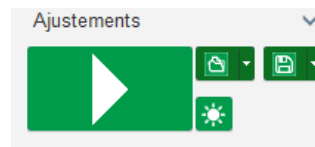

4.3.9 Zoom feature

You can zoom in (or out) on the oscilloscope plotting area.

First select in the oscilloscope plotting area.

- Hold the **Ctrl** key and use the mouse wheel:
 - Both the X and Y axes are then modified.
- Hold the **Alt** key and scroll the mouse wheel:
 - Only the X axis is modified, the scales on the Y axis remain the same.
- Hold the **Shift** key and scroll the mouse wheel:
 - Only the Y axis is modified, the scales on the X axis remain the same.

4.4 Monitor

4.4.1 Monitor window

This window is used to configure the parameter display in different forms (gauges, graphs, display units), as well as certain AVR specific components: PQ diagram, I/O, temperatures.

It is fully configurable and the various objects can be added, moved, modified and/or deleted.

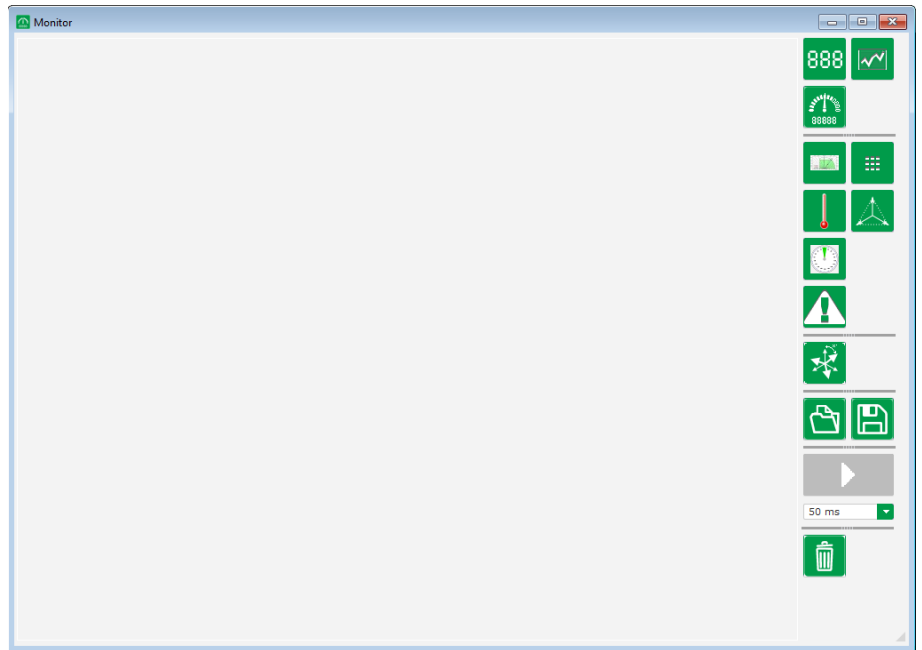

4.4.2 Add a display

You can add a new display for a parameter value.

Select the **New Display**  icon.

Select the parameter you wish to display from the drop-down list.

This parameter can be an analogue or a digital value.

Select **OK** to use the selected parameter.

The display is added to the monitor in the next free slot.

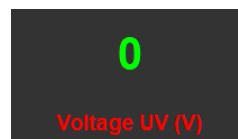
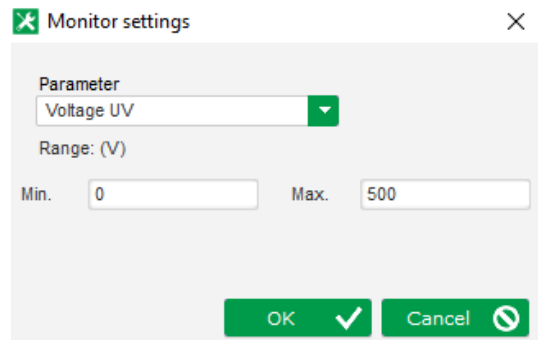

4.4.3 Add a curve

You can add a new curve for a parameter value.

Select the **New curve**  icon.

Select the parameter you wish to display from the drop-down list.

This parameter can be an analogue or a digital value.

Select **OK** to use the selected parameter.

The curve is added to the monitor in the next free slot.

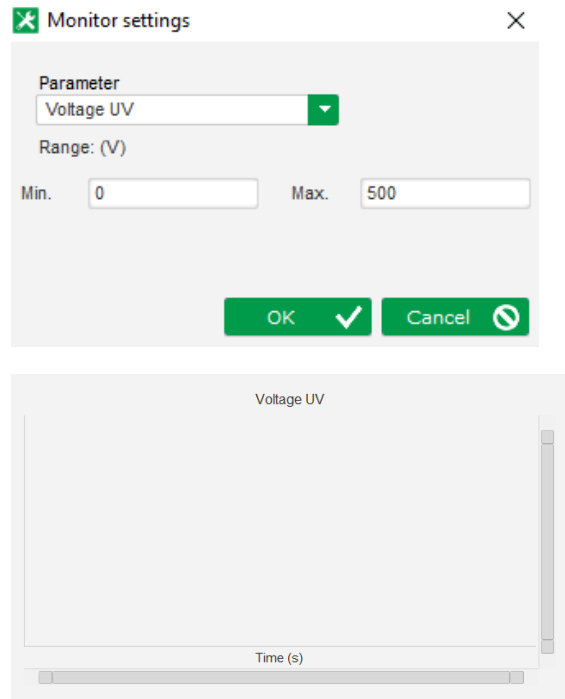

4.4.4 Add a gauge

You can add a new gauge for a parameter value.

Select the **New gauge**  icon.

Select the parameter you wish to display from the drop-down list.

This parameter can be an analogue or a digital value.

Select **OK** to use the selected parameter.

The gauge is added to the monitor in the next free slot.

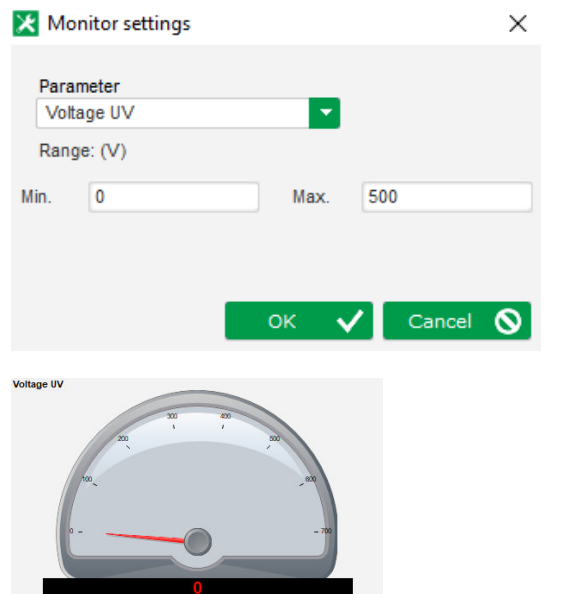

4.4.5 Add a capability curve

You can add a capability curve. *

Select the **New capability diagram**  icon.

The curve is added to the monitor in the next free slot.

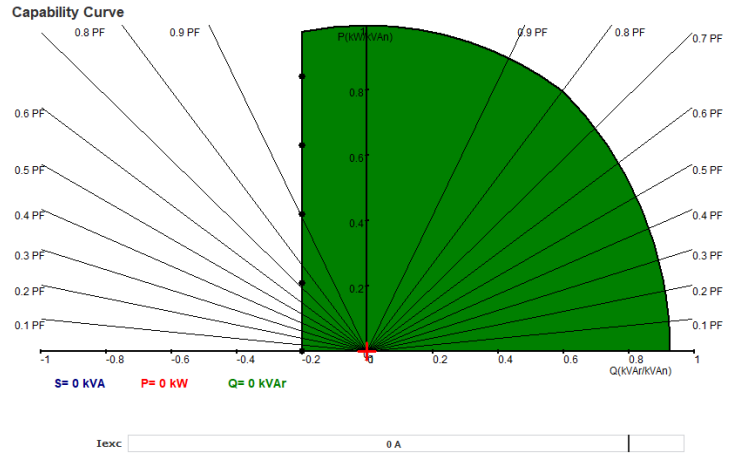

NOTE * Only one PQ diagram can be added to the monitor.

4.4.6 Add inputs/outputs

You can add an inputs/outputs panel. *

Select the **Inputs/outputs Analogs/Digitals**  icon.

The inputs/outputs panel is added to the monitor in the next free slot.

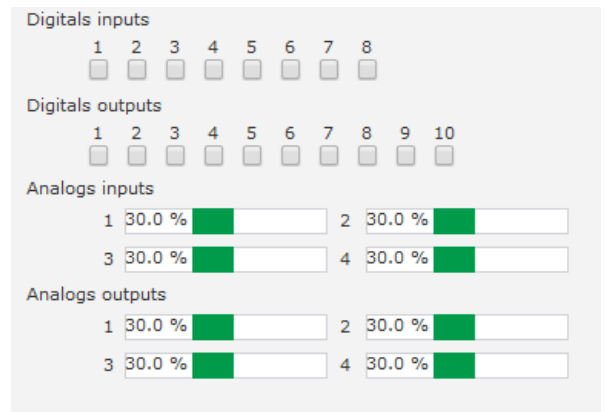

NOTE * Only one inputs/outputs panel can be added to the monitor.

4.4.7 Add temperatures

You can add the temperature panel. *

Select the **RTD**  icon.

The panel is added to the monitor in the next free slot.

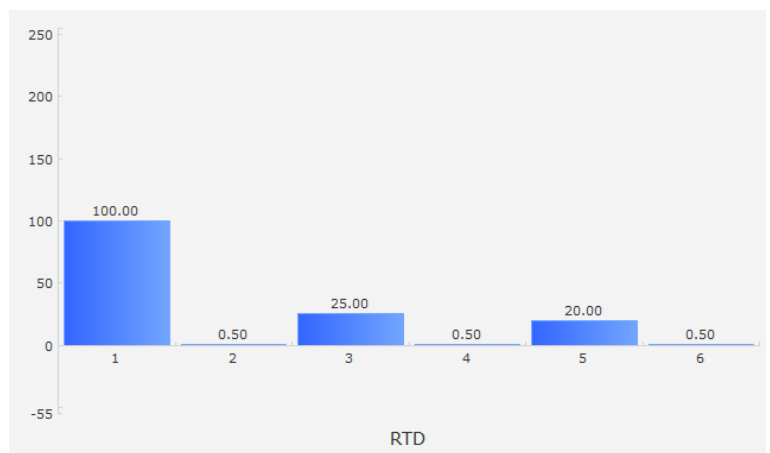

NOTE * Only one temperature panel can be added to the monitor.

4.4.8 Add synchronisation

You can add the synchronisation panel. *

Select the **Synchronizer**  icon.

The panel is added to the monitor in the next free slot.

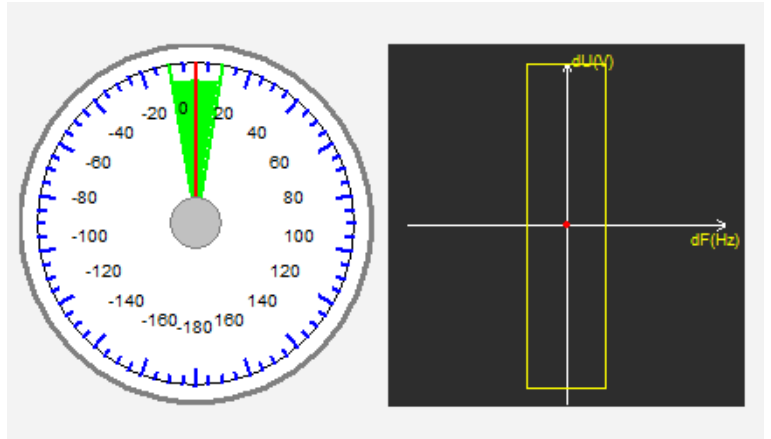

The left side of the panel shows the angle difference between the grid and the alternator voltage.

The right side of the panel shows with a red dot whether the difference in frequency and voltage is between the alternator and the grid voltage is in the configured range.

NOTE * Only one synchronisation panel can be added to the monitor.

4.4.9 Add AVR status and faults

You can add the AVR status and faults panel.

Select the **AVR status**  icon.

The panel is added to the monitor in the next free slot.

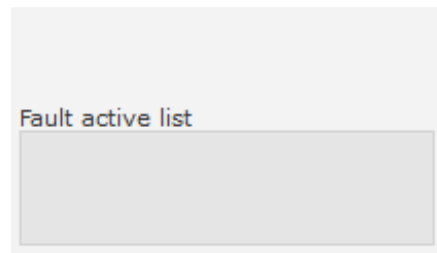

This panel shows the DVC 550 operating information, the regulation mode in progress, and a list of active faults.

4.4.10 Edit mode : Resize or delete panels

To change to **Edit mode**:

Right click in the monitor area and select **Edit mode**.

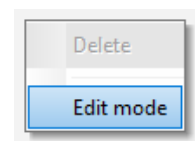

A grid then appears on the monitor area.

To resize a panel:

- Move over a side or the bottom right corner of the panel.
- Select and drag to resize the panel.

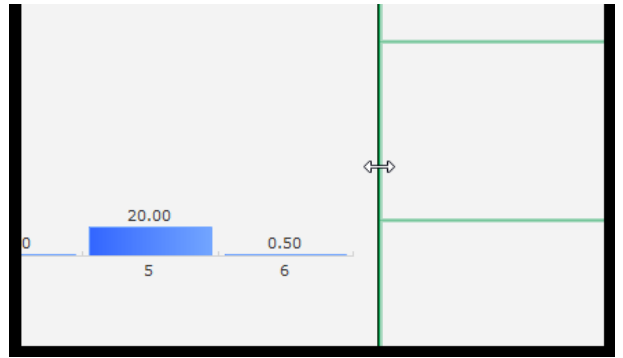

Right click on a panel and select **Delete** to remove that panel.

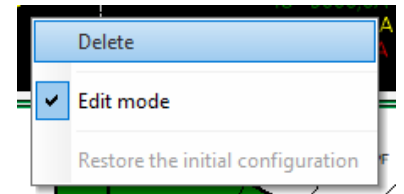

To leave **Edit mode** either:

- Right click in the monitor area and select **Edit mode** again to stop editing.
- Press **Esc** on your keyboard to stop editing.

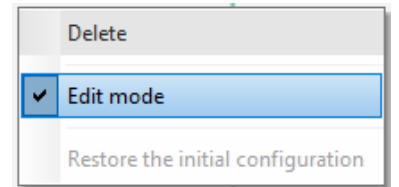

4.4.11 Start or stop monitor

To start the monitor select the start icon.



To stop the monitor select the stop icon.



You can change how often the monitor window is refreshed.

Use the drop-down list to select a new refresh.

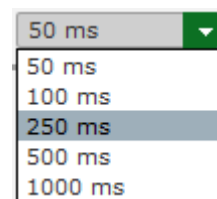

4.4.12 Save a monitor configuration

Select **Save**  to save the monitor configuration.

Compare two configuration files

Select ... under File 1 for the first configuration file.



Select ... under File 2 for the second configuration file.

Select **Compare**.

Differences between the two files are displayed in a list.

Parameter Number	Parameter name	File 1 value	File 2 value	Unit
005.019	D13 Destination	0	2003	
005.022	D16 Destination	2003	0	
002.010	Stator current Limit Enable	Active	Not active	
004.001	Voltage setpoint	0	400	V
014.071	QU External Input	0	400	
014.084	QU2 External Input	0	400	
015.024	RTD1 : Type of temperature sensor	PT100	None	

4.6 Create a PDF report

You can create a PDF report of the configuration settings. *

Select **Print**  from under the **Home** option.

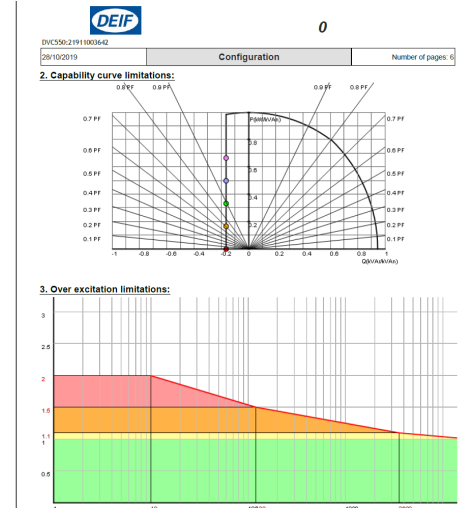
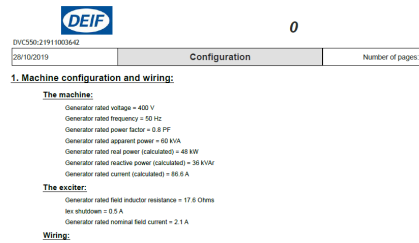

4.7 Excel Export

You can export the configuration settings as an Excel spreadsheet.

Select **Save**  from under the **Home** option.

Select **Export to Excel**.

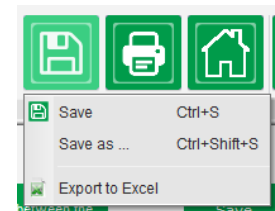

The file created contains each parameter with:

- Identifier (ID)
- Parameter name
- Minimum value
- Maximum value
- Value measured
- Default value
- Unit

Id	Parameter name	Minimum value	Maximum value	Value	Initial value	Unit
000.000	Monitor Menu					
000.001	U	0	100000	0	0	V
000.002	I	0	10000	0.0	0	A
000.003	P	0	1000000	0	0	kW
000.004	PF	-1	1	0.000	0	PF
000.005	F	0	500	0.0	0	Hz
000.006	U21	0	100000	0	0	V
000.007	U32	0	100000	0	0	V
000.008	U13	0	100000	0	0	V
000.009	I1	0	10000	0.0	0	A
000.010	I2	0	10000	0.0	0	A
000.011	I3	0	10000	0.0	0	A
000.012	Q	0	1000000	0	0	kVAR
000.013	S	0	1000000	0	0	kVA
000.014	If	0	50	0.00	0	A
000.015	Vf	0	500	0.0	0	V
000.016	Vbus	0	500	0.0	0	V
001.000	SystemData					
001.001	Voltage UN	0	100000	44	0	V
001.002	Voltage VN	0	100000	44	0	V
001.003	Voltage WN	0	100000	45	0	V
001.004	Voltage UV	0	100000	77	0	V
001.005	Voltage VW	0	100000	77	0	V
001.006	Voltage WU	0	100000	77	0	V
001.007	Line Current U	0	10000	5.2	0	A

5. Configure the DVC 550

5.1 Generator description

Generator data

Describe all the alternator characteristics: voltage (in Volts), apparent power (in kVA), frequency (in Hz), and power factor.

Fields: rated current, reactive power and active power are calculated automatically.

Pole ratio for diode fault (exciter poles number divided by generator poles number).

Generator data	
Rated voltage (V)	<input type="text" value="400.00"/>
Rated frequency (Hz)	<input type="text" value="50.00"/>
Rated power factor	<input type="text" value="0.80"/>
Rated apperant power (kVA)	<input type="text" value="50.00"/>
Rated nominal power (kW)	<input type="text" value="40.00"/>
Rated reactive power (kVar)	<input type="text" value="30.00"/>
Rated current (A)	<input type="text" value="72.17"/>
Pole ratio between exciter and generator	<input type="text" value="0.0"/> 

Excitation data

Describe all the field excitation characteristics: exciter field resistance (in ohms), shutdown field current (in Amps), and rated field current (in Amps).

Excitation data	
Field inductor resistance (Ohms)	<input type="text" value="0.00"/>
Shutdown field current (A)	<input type="text" value="0.50"/>
Rated field current (A)	<input type="text" value="1.00"/>

5.2 Wiring

Configure the wiring connections between the DVC 550 and the alternator.

The wiring preview changes according to the settings.

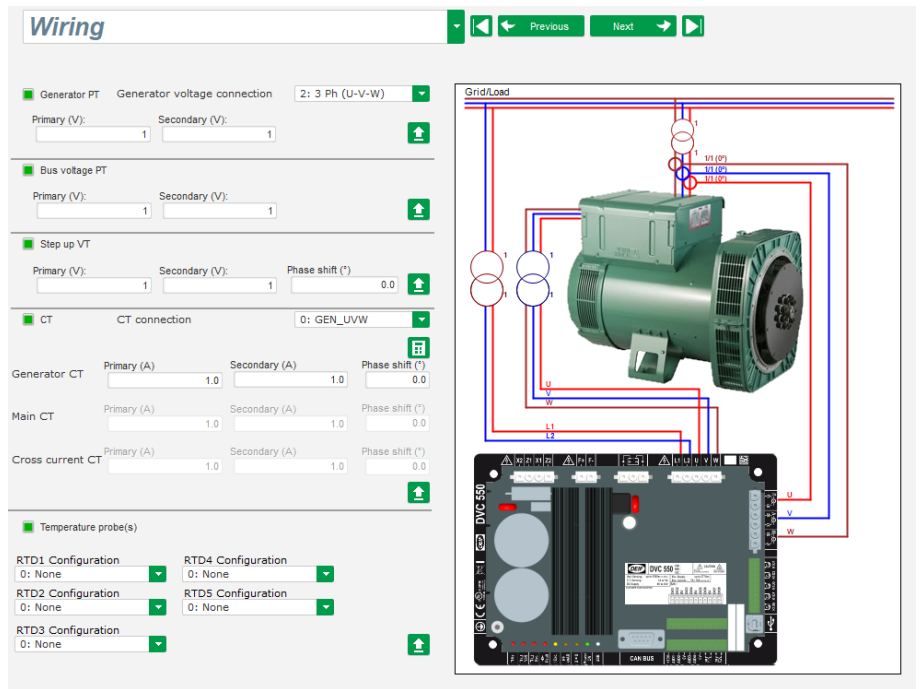

Alternator voltage measurement PTs

- State the primary and secondary winding voltages (in Volts).
- State the type of measurement: phase-neutral, phase-phase, 3 phases or 3 phases and neutral using the drop-down menu.



Alternator current measurement CTs

- State the primary and secondary winding currents (in Amps).
- Indicate the IT configuration using the drop-down menu.

NOTE The phase shift value should be set during tests and commissioning. It is used to compensate for the phase difference caused by the CTs and VTs.

If an isolation CT is present, the secondary parameter value should correspond to the isolation CT secondary.

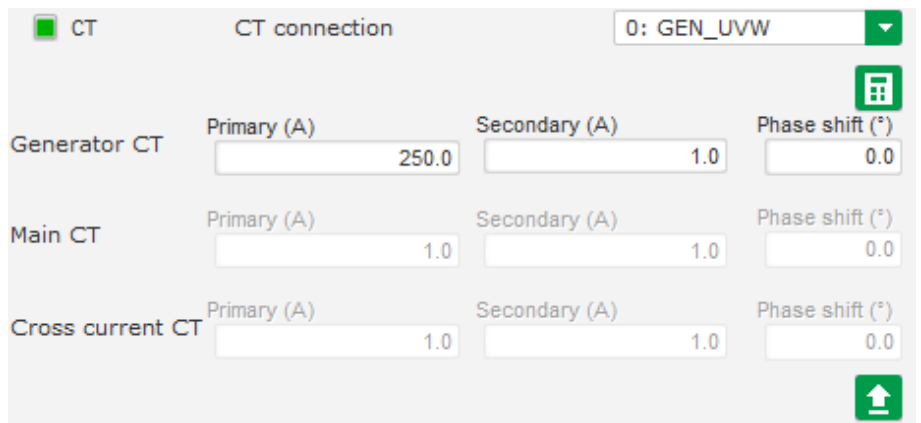

Bus voltage measurement VTs

- State the primary and secondary winding voltages (in Volts).

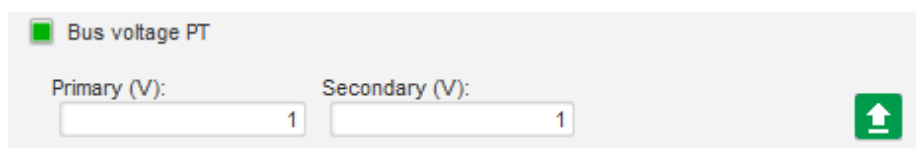

Bus current measurement CT: Placed in the V phase

- If this is present, choose the 4 mode.
- State the primary and secondary winding currents in Amps).
- This input is also used for Grid code over current detection.

CT connection 4: GEN_U_MAIN_V

	Primary (A)	Secondary (A)	Phase shift (°)
Generator CT	250.0	1.0	0.0
Main CT	1.0	1.0	0.0
Cross current CT	1.0	1.0	0.0

Step-up VT

This VT corresponds to a power transformer which can be found between the alternator and the grid. It makes it easier to calculate the voltage when matching the grid voltage, especially if the ratios between the primary and secondary on the various measurement VTs are not identical.

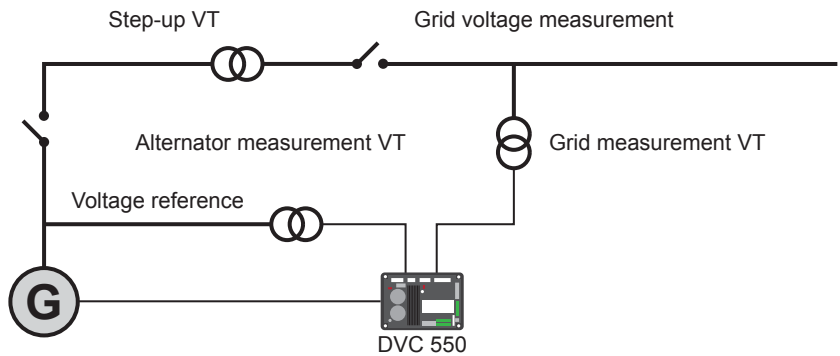

The “primary” corresponds to the machine (on the production side) and the secondary on the grid side.

Indicate the primary and secondary winding voltages (in Volts).

Step up VT

Primary (V):	Secondary (V):	Phase shift (°)
250	1	0.0

PT100 and PTC

- Select PT100 or PTC inputs.

Temperature probe(s)

RTD1 Configuration	RTD4 Configuration
0: None	0: None
RTD2 Configuration	RTD5 Configuration
0: None	0: None
RTD3 Configuration	
0: None	

5.3 Limitations

5.3.1 Capability curve limitations : Under excitation limitation

This limit corresponds to the absorption limit defined in the capability curve. It is defined with five points.

We recommend using kVAr values slightly higher than the curve point so that the alternator can operate in complete safety. These points can be defined as an actual value (kVAr and kW) or as a percentage of kVA.

Example of a capability curve:

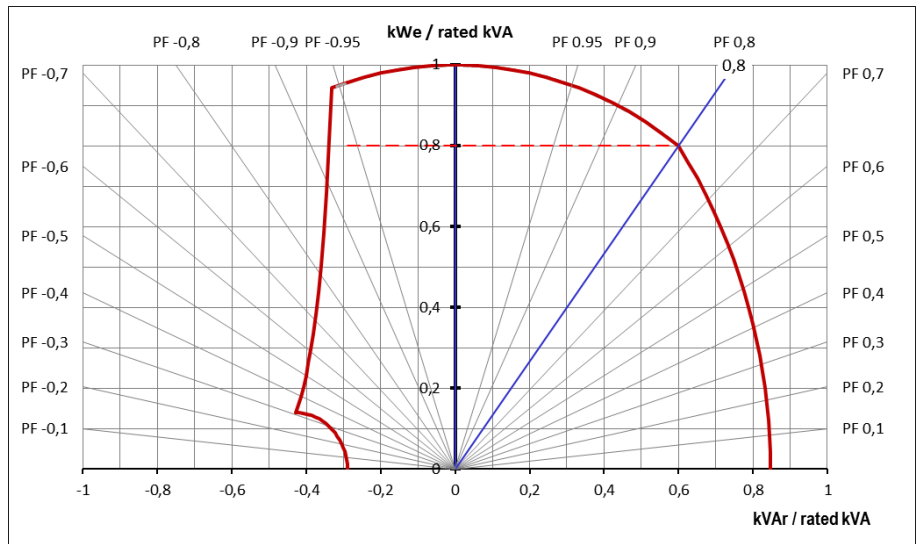

Configure the five points for the capability curve.

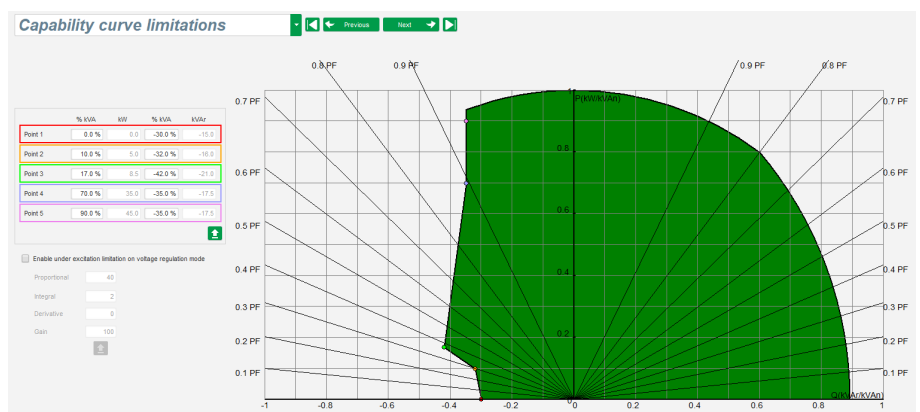

This limitation is activated as soon as the operating point reaches this limit. The field current is then controlled so that the alternator stays in the area defined by the capability curve.

If needed, select **Enable under excitation limitation on voltage regulation mode** and configure the settings.

5.3.2 Over excitation limitation

Over excitation limitation is defined in 3 different parts using 3 points which define the areas. These points are determined according to the machine capability.

The common adjustment values are:

- 2.5 time of the rated field current for 10 seconds for the stator short-circuit.
- 1.5 times the rated field current for 10 seconds up to 120 seconds.
- 1.1 times the rated field current for 10 seconds up to 3600 seconds.

When the field current exceeds the value of the rated current, a counter is triggered.

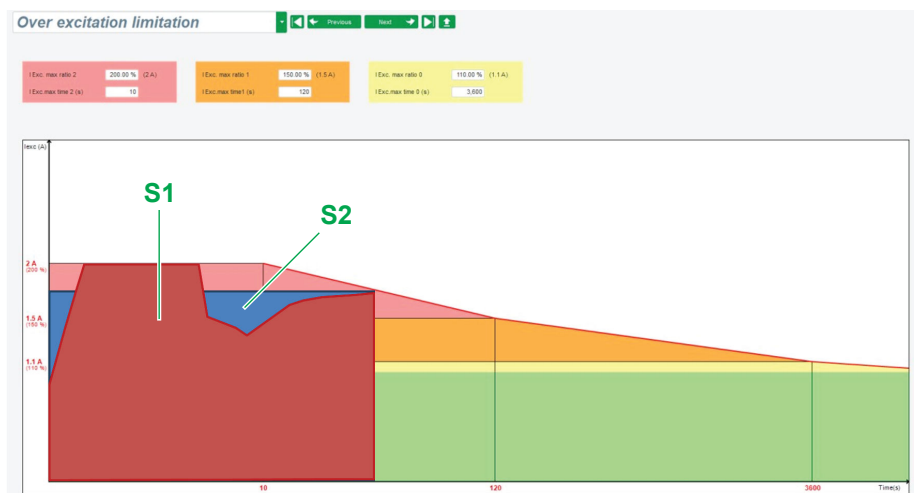

The **S1** "field current measurement x time" area (shown in red) is then compared with the "maximum field current x time" area (shown in blue).

If **S1** equals **S2**, the limit is active and the DVC 550 limits the field current to 99% of the rated current (which in this case results in the interruption of the regulation mode in progress).

NOTE If the limit is active, in order to protect the machine, it is only possible to have a current higher than 99% of the rated current after 24 hrs.

5.3.3 Stator current limitation

Stator current limitation is defined in 3 different parts using 3 points which define the areas. These points are determined according to the machine capability.

The common adjustment values are:

- 3 times the rated stator current for 10 seconds for the stator short-circuit.
- 1.5 times the rated stator current for 10 seconds up to 120 seconds.
- 1.1 times the rated stator current for 10 seconds up to 3600 seconds.

When the stator current exceeds the value of the rated current, a counter is triggered.

The **S1** "stator current measurement x time" area (shown in red) is then compared with the "maximum stator current x time" area (shown in blue).

If **S1** equals **S2**, the limit is active and the DVC 550 limits the stator current to 99% of the rated current (which in this case results in the voltage reference not being tracked).

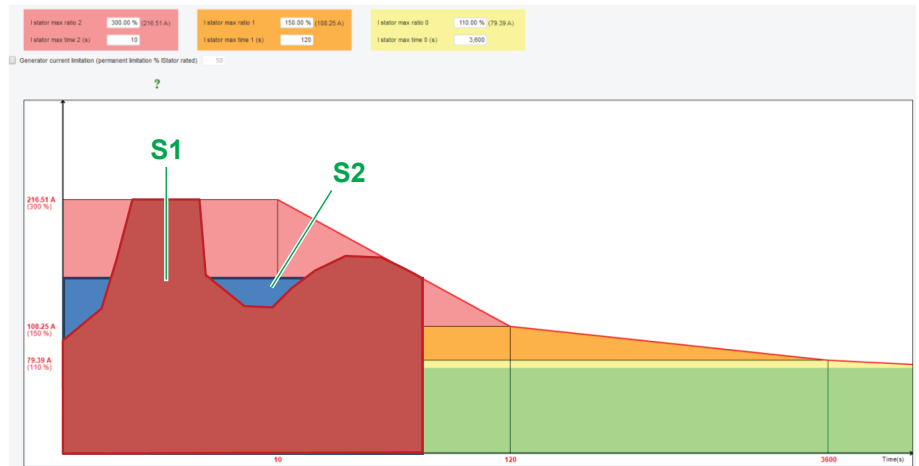

5.3.4 Generator current limitation

You can also enable **Generator current limitation**.

This is a permanent limitation percentage (%) of $I_{\text{Stator rated}}$ (A).

In this example, shown as the purple line it is 50 % (43.3 A).

The current limitation gain must be adjusted to improve the regulation stability during the prime mover starting sequence.

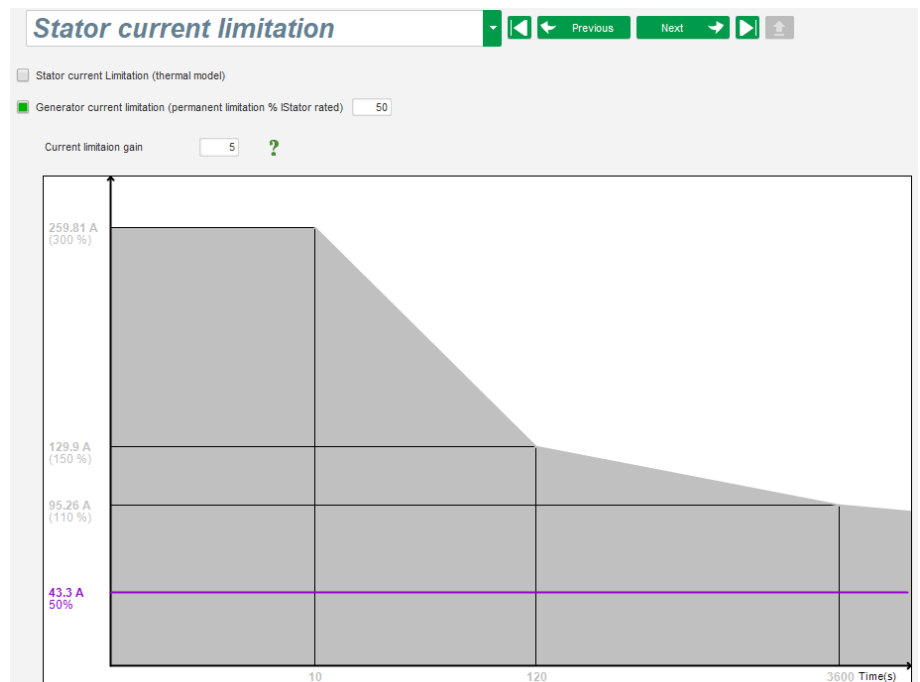

5.4 Protections

5.4.1 Protections

Configure the protections provided by the DVC 550.

Examples:

- Rotating diode failure
- Over-voltage
- Under-voltage

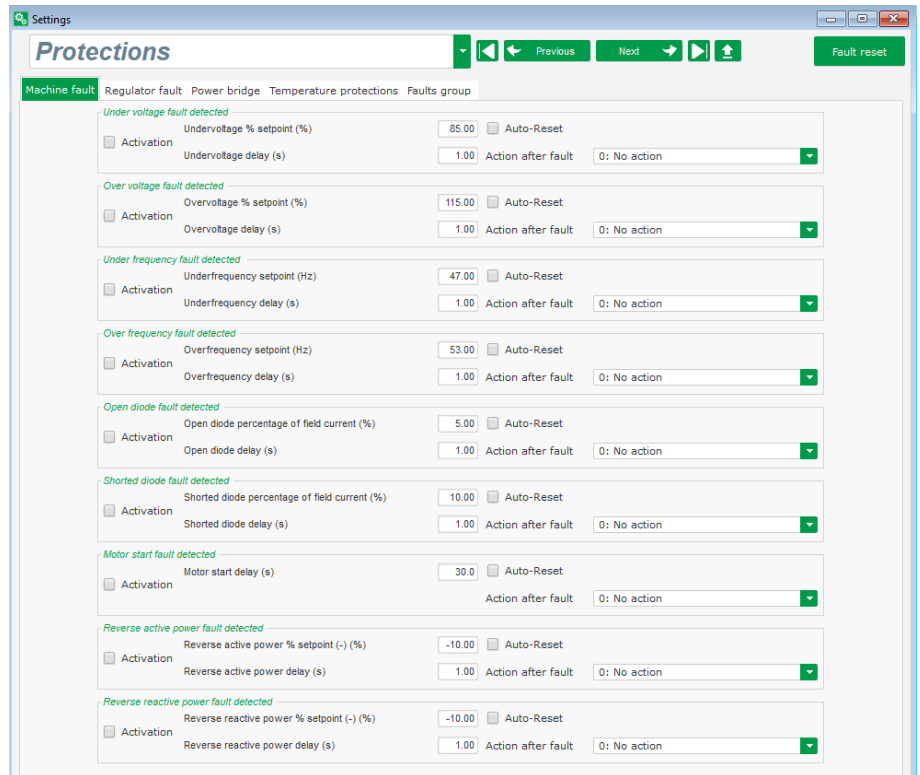

To enable a protection, select **Activation** and then configure the settings as needed.

Activated protections are shown in light green.



More information

See **Protections** in **About the DVC 550** for more information about each of the protections, their setting ranges, and their default settings.

5.4.2 Faults group

You can group faults in to a fault group:

- Group 1
- Group 2
- Group 3
- Group 4

If any fault is activated in the group, the output for that group is also activated.

You can use the group output state with a digital output or as input on a logical gate.

Protections				
Machine fault Regulator fault Power bridge Temperature protections Faults group				
Fault	Group 1	Group 2	Group 3	Group 4
Overvoltage fault class	<input type="checkbox"/>	<input type="checkbox"/>	<input type="checkbox"/>	<input type="checkbox"/>
Undervoltage fault class	<input type="checkbox"/>	<input type="checkbox"/>	<input type="checkbox"/>	<input type="checkbox"/>
Overfrequency fault class	<input type="checkbox"/>	<input type="checkbox"/>	<input type="checkbox"/>	<input type="checkbox"/>
Underfrequency fault class	<input type="checkbox"/>	<input type="checkbox"/>	<input type="checkbox"/>	<input type="checkbox"/>
Open diode fault class	<input checked="" type="checkbox"/>	<input type="checkbox"/>	<input type="checkbox"/>	<input type="checkbox"/>
Shorted diode fault class	<input checked="" type="checkbox"/>	<input type="checkbox"/>	<input type="checkbox"/>	<input type="checkbox"/>
Reverse active power fault class	<input type="checkbox"/>	<input type="checkbox"/>	<input type="checkbox"/>	<input type="checkbox"/>
Reverse reactive power fault class	<input type="checkbox"/>	<input type="checkbox"/>	<input type="checkbox"/>	<input type="checkbox"/>
PT100 1 Alarm (Over temp) fault class	<input type="checkbox"/>	<input checked="" type="checkbox"/>	<input type="checkbox"/>	<input type="checkbox"/>
PT100 1 fault class	<input type="checkbox"/>	<input type="checkbox"/>	<input type="checkbox"/>	<input type="checkbox"/>
PT100 2 Alarm (Over temp) fault class	<input type="checkbox"/>	<input checked="" type="checkbox"/>	<input type="checkbox"/>	<input type="checkbox"/>
PT100 2 fault class	<input type="checkbox"/>	<input type="checkbox"/>	<input type="checkbox"/>	<input type="checkbox"/>
PT100 3 Alarm (Over temp) fault class	<input type="checkbox"/>	<input checked="" type="checkbox"/>	<input type="checkbox"/>	<input type="checkbox"/>
PT100 3 fault class	<input type="checkbox"/>	<input type="checkbox"/>	<input type="checkbox"/>	<input type="checkbox"/>
PT100 4 Alarm (Over temp) fault class	<input type="checkbox"/>	<input checked="" type="checkbox"/>	<input type="checkbox"/>	<input type="checkbox"/>
PT100 4 fault class	<input type="checkbox"/>	<input type="checkbox"/>	<input type="checkbox"/>	<input type="checkbox"/>
PT100 5 Alarm (Over temp) fault class	<input type="checkbox"/>	<input checked="" type="checkbox"/>	<input type="checkbox"/>	<input type="checkbox"/>
PT100 5 fault class	<input type="checkbox"/>	<input type="checkbox"/>	<input type="checkbox"/>	<input type="checkbox"/>
PTC 1 fault class	<input type="checkbox"/>	<input type="checkbox"/>	<input type="checkbox"/>	<input type="checkbox"/>
PTC 2 fault class	<input type="checkbox"/>	<input type="checkbox"/>	<input type="checkbox"/>	<input type="checkbox"/>
PTC 3 fault class	<input type="checkbox"/>	<input type="checkbox"/>	<input type="checkbox"/>	<input type="checkbox"/>
PTC 4 fault class	<input type="checkbox"/>	<input type="checkbox"/>	<input type="checkbox"/>	<input type="checkbox"/>
PTC 5 fault class	<input type="checkbox"/>	<input type="checkbox"/>	<input type="checkbox"/>	<input type="checkbox"/>
Loss of sensing fault class	<input type="checkbox"/>	<input type="checkbox"/>	<input type="checkbox"/>	<input type="checkbox"/>
Unbalance voltage fault class	<input type="checkbox"/>	<input type="checkbox"/>	<input type="checkbox"/>	<input type="checkbox"/>
Unbalance current fault class	<input type="checkbox"/>	<input type="checkbox"/>	<input type="checkbox"/>	<input type="checkbox"/>
Short circuit fault class	<input type="checkbox"/>	<input type="checkbox"/>	<input type="checkbox"/>	<input type="checkbox"/>
IGBT fault class	<input type="checkbox"/>	<input type="checkbox"/>	<input type="checkbox"/>	<input type="checkbox"/>
Motor start fault class	<input type="checkbox"/>	<input type="checkbox"/>	<input type="checkbox"/>	<input type="checkbox"/>
Power bridge overload fault class	<input type="checkbox"/>	<input type="checkbox"/>	<input type="checkbox"/>	<input type="checkbox"/>
Battery under voltage fault class	<input type="checkbox"/>	<input type="checkbox"/>	<input type="checkbox"/>	<input type="checkbox"/>
CAN under voltage fault class	<input type="checkbox"/>	<input type="checkbox"/>	<input type="checkbox"/>	<input type="checkbox"/>



Example with a digital output

The output from **Group 1 fault status** is used as the output on **DO1**:

Digital Outputs

Source	Active	Digital Output
Group 1 fault status	Active Low	DO1
None	Active Low	DO2
None	Active Low	DO3
None	Active Low	DO4
None	Active Low	DO5
None	Active Low	DO6
None	Active Low	DO7
None	Active Low	DO8
None	Active Low	RL1
None	Active Low	RL2

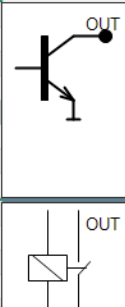

Example with a logic gate

The output from **Group 1 fault status** is used as input **E1** on an **OR** logic gate:

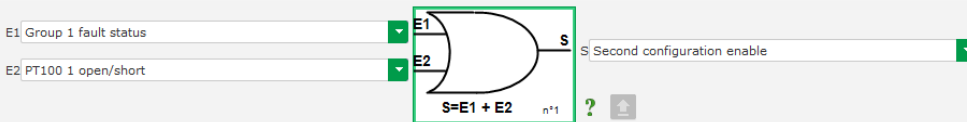

5.5 Regulation mode

5.5.1 Determination of the regulation mode

The regulation mode to be configured depends on the alternator operation:

- Standalone.
- Parallel between machines.

- Parallel with the grid.



More information

If the alternator is not connected to the grid, continue configuration from **Regulation mode : Field current (manual mode)**.

5.5.2 Start-up - Set the ramp

The start-up ramp time is the time taken to reach the machine's voltage reference (or field current reference).

For an immediate start, put **0 s** in the ramp time.

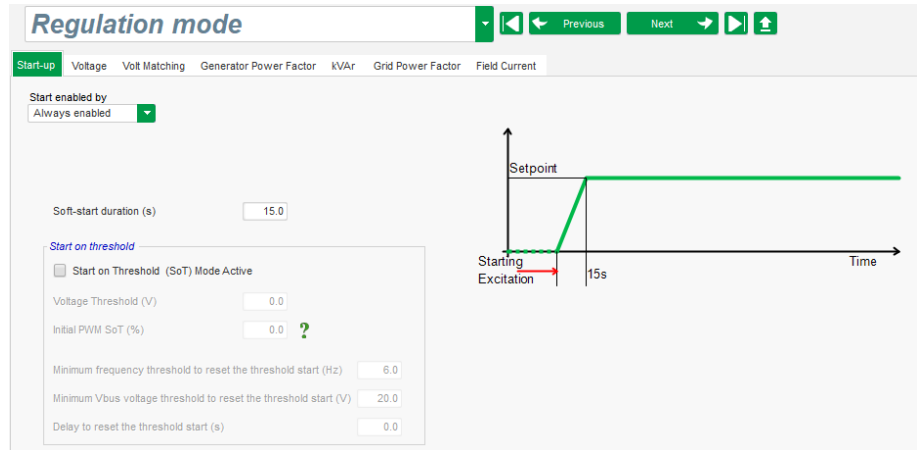

Select the field excitation starting mode from the drop-down list:

- Control with a digital input (DI1 to DI8).
- Always active by selecting **Always enabled**.
 - The field excitation is always energised as soon as the product is powered up.
- Control with the result of a logic gate.

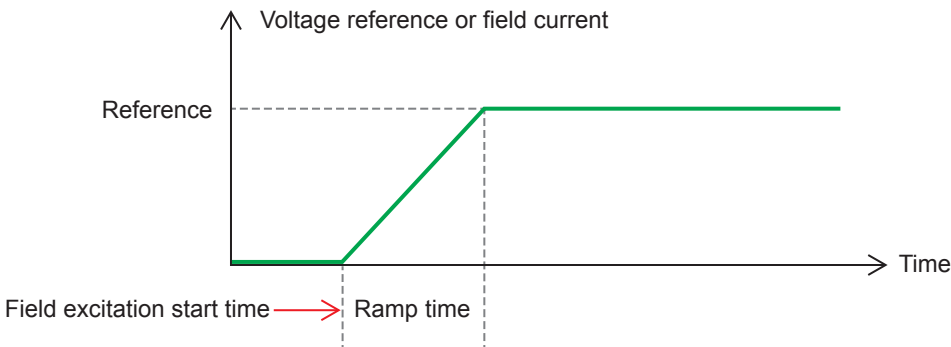

5.5.3 Voltage regulation

This regulation must always be active.

Select **Always enabled** in the drop-down list.



The reference point is configured by either:

- An **Internal set point** fixed reference.
- An **Analogue input** set with a range.

If a value is configured this value can be changed with the CAN bus.

The limits of the reference should be fixed, depending on the machine capability.

In this example, the minimum voltage reference is 0 % of 400 V, and the maximum voltage reference is 110 % of 400 V).

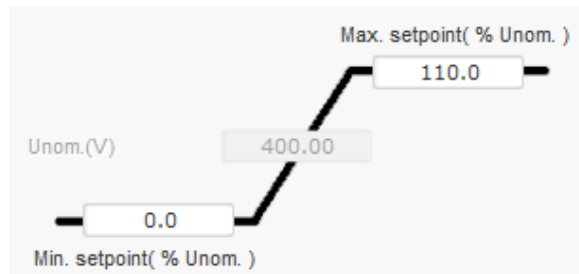

For **Internal set point** reference:

Configure the reference set point value.

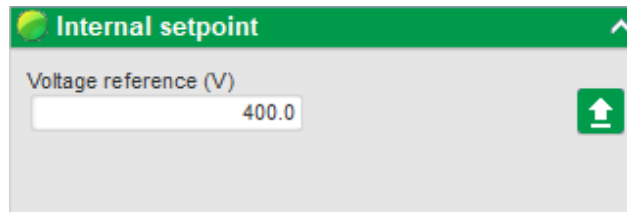

Set point adjustment: *

The set point can be adjusted with a **Step +/- U (V)** value to either increase or decrease the reference.

Digital inputs are used to trigger the increase or decrease.

A **Repeat delay**, in milliseconds (ms), gives a delay between the next increase or decrease applying.

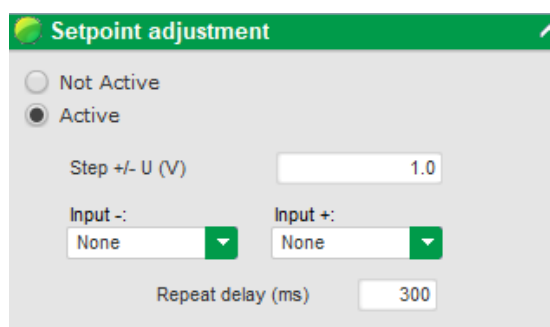

NOTE * **Set point adjustment** is only available to configure when used with the **Internal set point** reference. This option is not available when using an analogue input for the set point.

To use the set point adjustment, select **Active** and configure the values:

- **Step +/- U (V)**
 - Value used for either increase (**Input +**) or decrease (**Input -**)
- **Input -**
 - The digital input for the decrease trigger.
- **Input +**
 - The digital input for the increase trigger.
- **Repeat delay**
 - The repeat delay in milliseconds (ms) between steps.

NOTE The **Input +** and **Input -** digital inputs are the same for all regulation modes, but only affect the regulation modes in which they were enabled.

For **Analogue input set point** reference:

Select the analogue input to use:

- AIN1
- AIN2
- AIN3
- AIN4

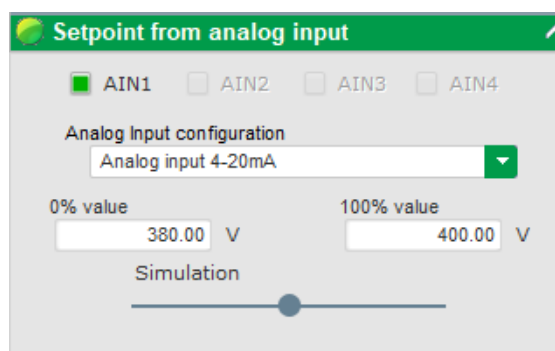

Select the analogue input configuration:

- 0/10 V
- +/-10 V
- 4-20 mA
- POT (Potentiometer)

Configure the voltage reference for 0 % and 100 % values.

NOTE The voltage terminals could be swapped if needed. For example, the minimum voltage for 100% of the analogue input, and the maximum voltage for 0% of the analogue input.

Use the **Simulation** selection to see the values obtained on the voltage and under frequency curves displayed at the right.

For under frequency there are two under speed settings.

Underspeed

Knee (Hz)	<input type="text" value="48.0"/>	Slope (V/Hz)	<input type="text" value="1.0"/>
-----------	-----------------------------------	--------------	----------------------------------

These values are used to set the voltage drop as a function of the alternator speed.

Knee (Hz)

- The typical values are:
 - 48 Hz for an alternator with 50 Hz rated frequency.
 - 57 Hz for an alternator with 60 Hz rated frequency.
 - 380 Hz for an alternator with 400 Hz rated frequency.

Slope (V/Hz)

- Adjustable from 0.5 to 3 V/Hz
- The higher the slope value, the greater the voltage drop will be if the prime mover speed drops.

The curve drawing for **Typical underspeed curve** is changed as a function of these two values:

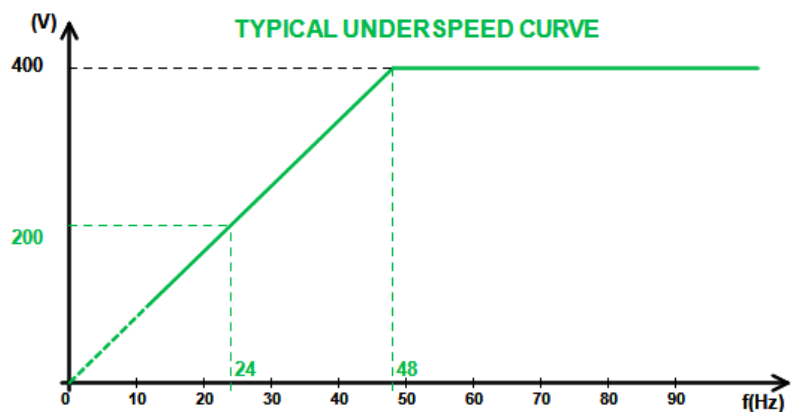

Quadrature droop

Select to enable this function.

The default value is 3 %.

Configure the voltage drop percentage between -20 % and +20 %.

NOTE A negative value corresponds to an increase in voltage.

This function is mainly used with alternators operating in parallel with one another.

Reactive droop compensation (%)

The curve drawing for **Reactive droop curve** is changed as a function of this value:

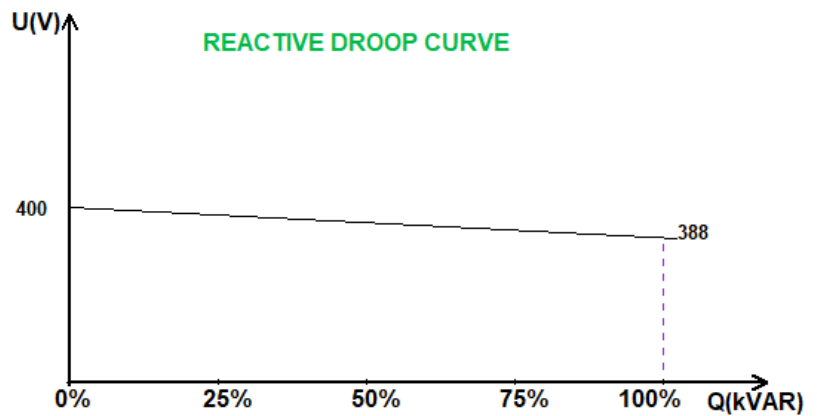

NOTE If quadrature droop has been enabled, it is no longer possible to have load compensation or cross current function.

Load compensation

Voltage line drop compensation (%)

Select to enable this function.

The default value is 3 %.

Configure the voltage reference change percentage between -20 % and +20 %.

This function is mainly used, depending on the kVA delivered by the machine, to:

- Increase the voltage reference (with a percentage between 1 % and 20 %) in the case of particularly long distribution lines.
- Decrease the voltage reference (with a percentage between -20 % and -1 %) to balance the loads for machines connected to a rectifier (DC bus).

The curve drawing for **Voltage curve** is changed as a function of this value:

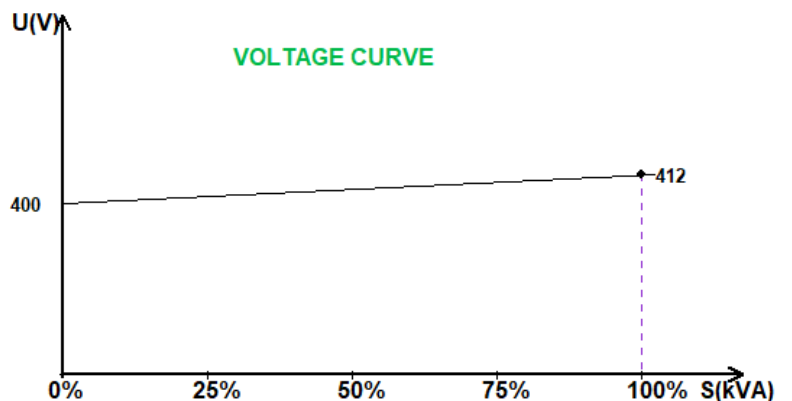

NOTE If load compensation has been enabled, it is no longer possible to have quadrature droop or the cross current function.

Cross current

Cross Current (% Voltage setpoint)

Select to enable this function.

This function requires special wiring.

Configure the voltage correction percentage as a function of the measured residual kVAr.

The system automatically corrects the voltage (temporarily) to permanently cancel the kVAr difference between machines, yet without lowering the regulation point.

NOTE If the cross current function has been enabled, it is no longer possible to have quadrature droop or load compensation.

Motor start

Generator current limitation (permanent limitation % IStator rated)

Select to enable this function.

Configure the percentage of rated stator current.

NOTE This function is active only in voltage regulation mode and allows limiting the stator current at a defined value.

When the breaker is closed between the motor and the generator, the DVC 550 continues regulating the voltage until the stator current measured reaches the limitation value. In this case, the DVC 550 regulates the stator current. When the motor reaches its rated speed, the current will decrease naturally and the voltage will increase. The DVC 550 will then return to voltage regulation mode.

To detect and prevent a possible bad motor starting event, a delay can be set between 1 s to 60 s on the protections page. If the voltage is not at the voltage set point when the delay has ended, the regulator will then respond based on the chosen action:

- No action
- Stop the regulation
- Field current regulation mode at shutdown value
- Field current regulation mode at value before the fault

If the motor breaker is closed before energising, this limitation has the priority and ramp time is not respected.

LAM: Load Acceptance Module.

This function improves the generator response reducing the voltage set point during a load impact.

[Engine help](#)

Soft voltage recovery (s/%) ?

Smart L.A.M. (%) L.A.M. (%) ?

L.A.M. (%)

L.A.M. duration (ms)

When the measured generator frequency is below the under-speed knee defined in the configuration (for example 48Hz or 57Hz), the voltage set point is decreased to a defined value (in the example above, 10 % under the rated voltage).

If frequency continues to fall, the voltage is regulated according to the U/f law.

The **Soft voltage recovery** helps the speed recovery of the generator. It is configured in seconds per percent of the rated voltage (s/%).



Example

If the frequency decreases by 10 % then the progressive rise time will be 1 second.

$$1 \text{ s} = 0.10 \text{ s/\%} * 10$$

NOTE If the slope of the progressive rise is greater than the U/f law, then the latter will be used to raise the voltage

The frequency stabilisation delay corresponds to the waiting time before the voltage set point is raised gradually (according to the increase of the frequency).

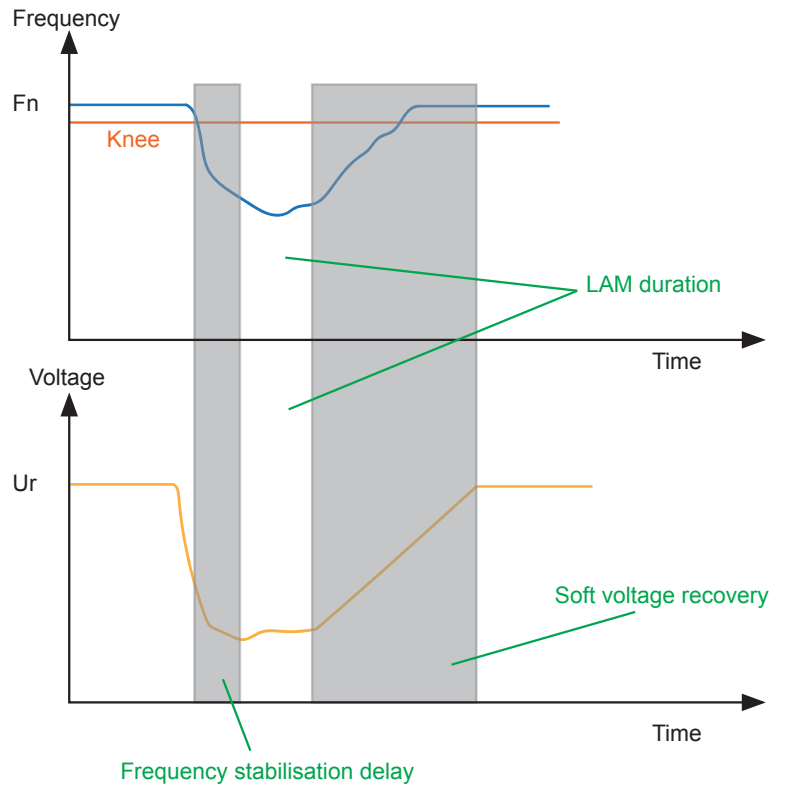

Smart LAM: Self-adaptive Load Acceptance Module. This function improves the generator response reducing the voltage set point during a load impact, but has an adaptive level.

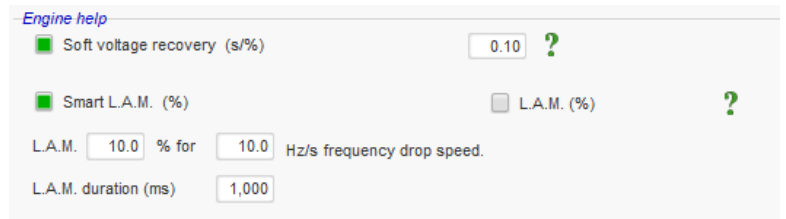

The controller measures the operating frequency and calculates its derivative permanently. From this derivative value, an attenuation coefficient (K) of the voltage is calculated according to the parameters configured by the user.

Example

For a frequency variation of 10 Hz/s, the applied voltage drop will be 10 % of the nominal voltage.

For each load impact, the voltage attenuation is determined by the formula:

$$\Delta U = K \times U_r$$

Where U_r is the rated voltage of the alternator.

The frequency stabilisation delay corresponds to the waiting time before the voltage set point is raised gradually (according to the increase of the frequency).

NOTE During the motor starting, all the other limitations, faults, and protections (under voltage, over voltage, stator limitation, under speed, under excitation, over excitation) have to be inactivate.

5.5.4 Volt matching

To connect an alternator to the grid, the grid voltage and the alternator voltage must be very close in value (less than 5% difference between the two measurements). The voltage matching circuit function is used to measure the instantaneous grid voltage as an alternator voltage reference.

NOTE This function requires one or two grid voltage measurement transformer(s).

Enable the voltage match circuit by selecting an activation type from the drop-down list.

- Controlled by a digital input (**DI1** to **DI8**)
- **Always enabled**
 - The voltage matching circuit is always switched on, depending on the order of priority of the regulations.



NOTE If **None** is selected, the voltage matching circuit is never enabled or is enabled by a logic gate.

5.5.5 Generator power factor

This regulation must be enabled when the machine connects to the grid (grid contactor closing) and disabled as soon as the machine is disconnected from the grid.

Configure the source of the grid connection contactor under **Grid breaker input**.

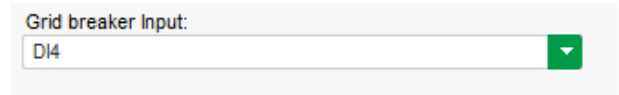

It can be chosen with kVAr regulation and regulation of the power factor at one point of the grid for machines connected to the grid.

This function is used to regulate the power factor at the machine terminals. It requires that the alternator current measurement must be connected (1 or 3 current transformers).

This regulation is activated by default as soon as the grid breaker is closed. The other regulation modes kVAr or power factor at a grid point, have priority over this regulation.

The reference point is configured by either:

- An **Internal set point** fixed reference.
- An **Analogue input** set with a range.

If a value is configured this value can be changed with the CAN bus.

The limits of the reference should be fixed, depending on the machine capability.

In this example, the power factor reference is fixed between 1 and 0.8 (supplying reactive power as seen by the generator).

These reference limits define the light green area on the capability diagram in which the reference can vary.

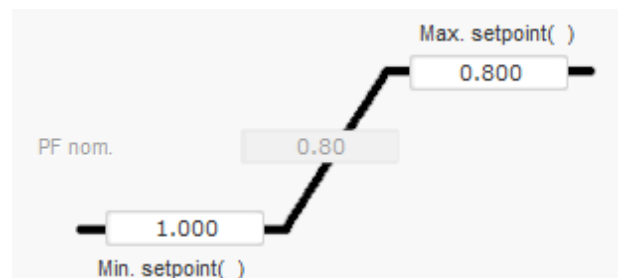

For **Internal set point** reference:

Configure the reference set point value.

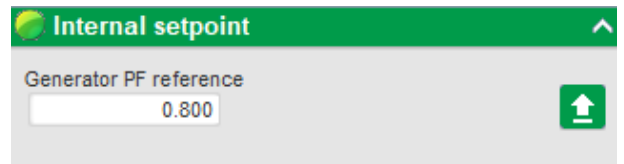

Set point adjustment: *

The set point can be adjusted with a **Step +/- PF** value to either increase or decrease the reference.

Digital inputs are used to trigger the increase or decrease.

A **Repeat delay**, in milliseconds (ms), gives a delay between the next increase or decrease applying.

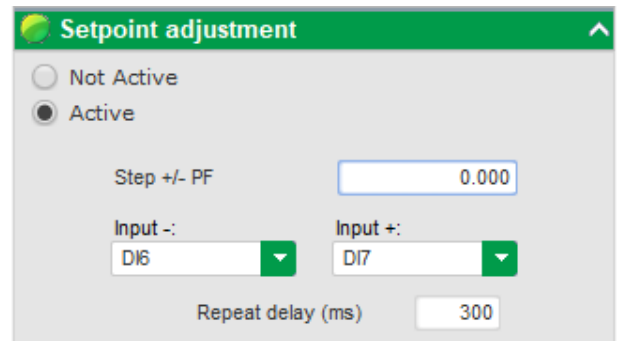

NOTE * **Set point adjustment** is only available to configure when used with the **Internal set point** reference. This option is not available when using an analogue input for the set point.

To use the set point adjustment, select **Active** and configure the values:

- **Step +/- PF**
 - Value used for either increase (**Input +**) or decrease (**Input -**)
- **Input -**
 - The digital input for the decrease trigger.
- **Input +**
 - The digital input for the increase trigger.
- **Repeat delay**
 - The repeat delay in milliseconds (ms) between steps.

NOTE The **Input +** and **Input -** digital inputs are the same for all regulation modes, but only affect the regulation modes in which they were enabled.

For **Analogue input set point** reference:

Select the analogue input to use:

- AIN1
- AIN2
- AIN3
- AIN4

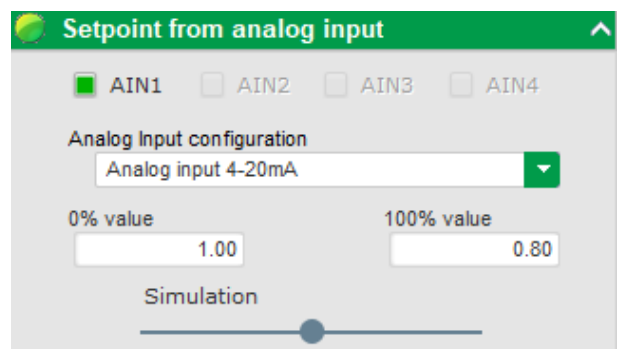

Select the analogue input configuration:

- 0/10 V
- +/-10 V
- 4-20 mA
- POT (Potentiometer) *

NOTE * Potentiometer is a 10k ohm.

Configure the voltage reference for 0 % and 100 % values.

NOTE The power factor reference could be swapped if needed. For example, the minimum power factor for 100% of the analogue input, and the maximum power factor for 0% of the analogue input.

Use the **Simulation** selection to see the power factor reference (blue line) on the capability diagram displayed at the right.

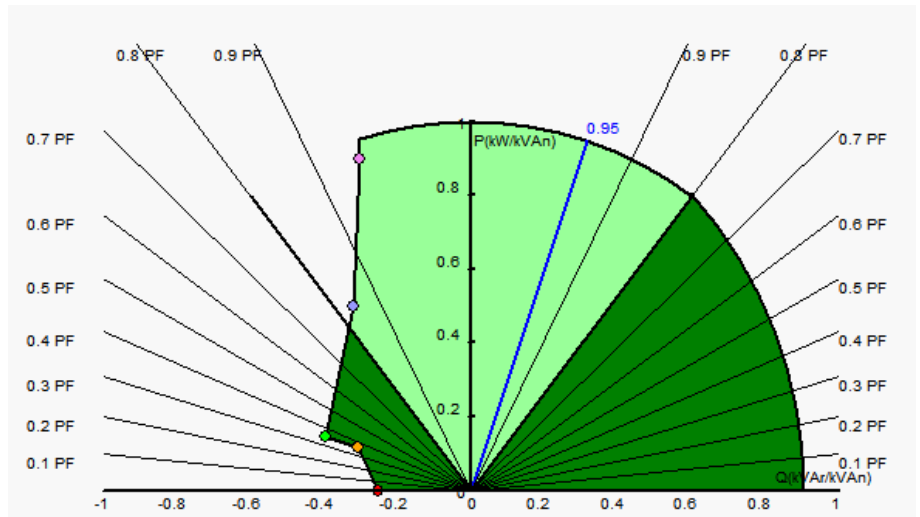

5.5.6 Generator kVAR

This regulation must be enabled when the machine connects to the grid (grid contactor closing) and disabled as soon as the machine is disconnected from the grid.

Configure the source of the grid connection contactor under **Grid breaker input**.

Grid breaker input:

The other options are regulation of the generator power factor or regulation of the power factor at one point of the grid for machines connected to the grid.

This function is used to regulate the kVAR value at the machine terminals. It requires that the alternator current measurement must be connected (1 or 3 current transformers).

Enable the regulation by selecting an activation type from the drop-down list.

- Controlled by a digital input (**DI1** to **DI8**)
- **Always enabled**
 - The kVAR regulation is always switched on, depending on the order of priority of the regulations.

Start-up Voltage Volt Matching Generator Power Factor **kVAR**

Regulation enabled by

NOTE If **None** is selected, the kVAR regulation is never enabled or is enabled by a logic gate.

The reference point is configured by either:

- An **Internal set point** fixed reference.
- An **Analogue input** set with a range.

If a value is configured this value can be changed with the CAN bus.

The limits of the reference should be fixed, depending on the machine capability.

In this example, the kVAr regulation is fixed between - 10 % of the alternator rated kVA power (drawing reactive power as seen by the generator) and 62 % of the alternator rated kVA power (supplying reactive power as seen by the generator).

These reference limits define the light green area on the capability diagram in which the reference can vary.

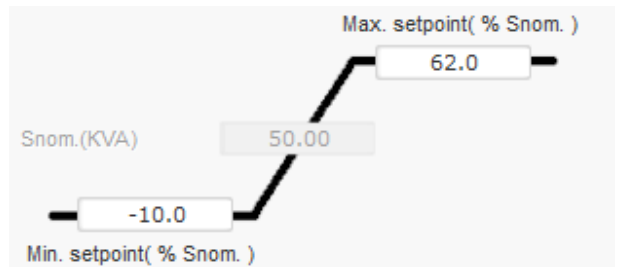

For **Internal set point** reference:

Configure the reference set point value.

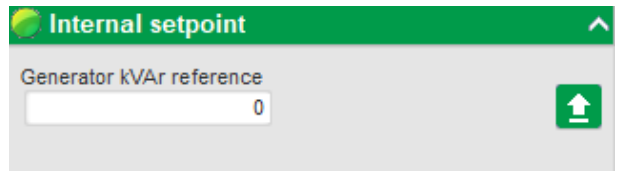

Set point adjustment: *

The set point can be adjusted with a **Step +/- kVAr** value to either increase or decrease the reference.

Digital inputs are used to trigger the increase or decrease.

A **Repeat delay**, in milliseconds (ms), gives a delay between the next increase or decrease applying.

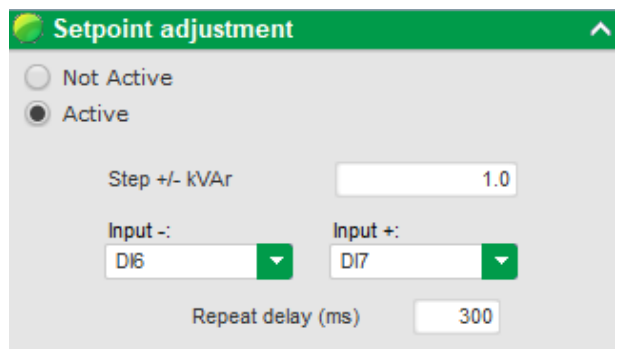

NOTE * **Set point adjustment** is only available to configure when used with the **Internal set point** reference. This option is not available when using an analogue input for the set point.

To use the set point adjustment, select **Active** and configure the values:

- **Step +/- kVAr**
 - Value used for either increase (**Input +**) or decrease (**Input -**)
- **Input -**
 - The digital input for the decrease trigger.
- **Input +**
 - The digital input for the increase trigger.
- **Repeat delay**
 - The repeat delay in milliseconds (ms) between steps.

NOTE The **Input +** and **Input -** digital inputs are the same for all regulation modes, but only affect the regulation modes in which they were enabled.

For **Analogue input set point** reference:

Select the analogue input to use:

- AIN1
- AIN2
- AIN3
- AIN4

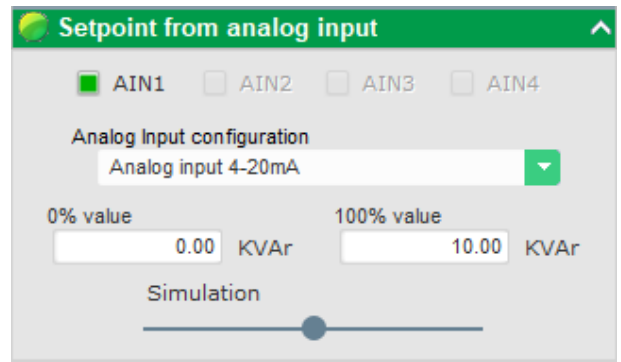

Select the analogue input configuration:

- 0/10 V
- +/-10 V
- 4-20 mA
- POT (Potentiometer)

Configure the voltage reference for 0 % and 100 % values.

NOTE The kVAR regulation terminals could be swapped if needed. For example, the minimum value for 100% of the analogue input, and the maximum value for 0% of the analogue input.

Use the **Simulation** selection to see the kVAR regulation (blue line) on the capability diagram displayed at the right.

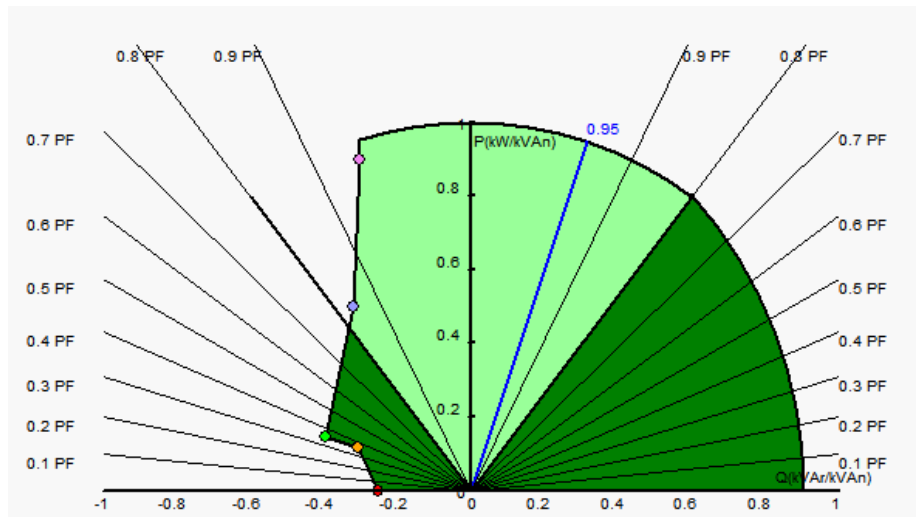

5.5.7 Grid power factor

This regulation must be enabled when the machine connects to the grid (grid contactor closing) and disabled as soon as the machine is disconnected from the grid.

Configure the source of the grid connection contactor under **Grid breaker input**.



This regulation is used to regulate the power factor at one point of the grid. The alternator current measurement must be connected.

Enable the regulation by selecting an activation type from the drop-down list.

- Controlled by a digital input (**DI1** to **DI8**)

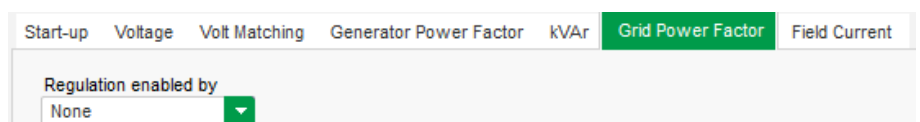

- **Always enabled**
 - The regulation of the power factor at one point of the grid is always enabled, depending on the order of priority of the regulations.

NOTE If **None** is selected, the regulation of the power factor at one point of the grid is never enabled or is enabled by a logic gate.

The reference point is configured by either:

- An **Internal set point** fixed reference.
- An **Analogue input** set with a range.

If a value is configured this value can be changed with the CAN bus.

The limits of the reference should be fixed, depending on the machine capability.

In this example, the power factor reference is fixed between 1 and 0.8 (supplying reactive power as seen by the generator).

The active limits must be those of the alternator to keep the machine in its capability diagram, but also those fixed in this page.

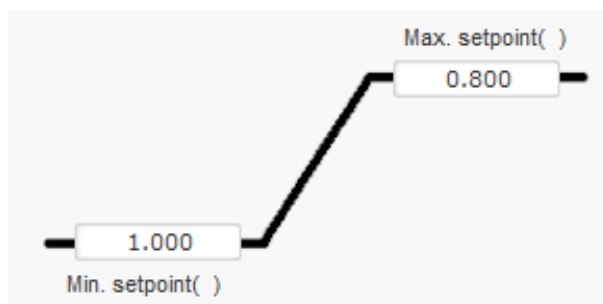

In certain conditions, there can be a grid power factor reference limit without actually being at the limit of this reference because the machine power factor reference is active.

These reference limits define the light green area on the capability diagram in which the reference can vary.

For **Internal set point** reference:

Configure the reference set point value.

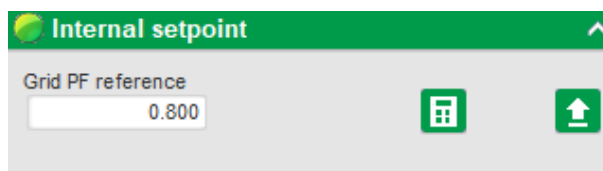

Set point adjustment: *

The set point can be adjusted with a **Step +/- PF** value to either increase or decrease the reference.

Digital inputs are used to trigger the increase or decrease.

A **Repeat delay**, in milliseconds (ms), gives a delay between the next increase or decrease applying.

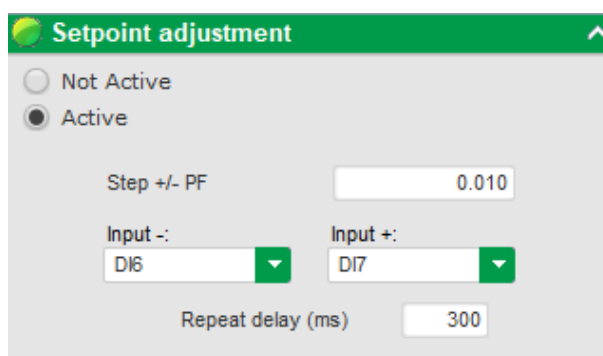

NOTE * **Set point adjustment** is only available to configure when used with the **Internal set point** reference. This option is not available when using an analogue input for the set point.

To use the set point adjustment, select **Active** and configure the values:

- **Step +/- PF**
 - Value used for either increase (**Input +**) or decrease (**Input -**)
- **Input -**

- The digital input for the decrease trigger.
- **Input +**
 - The digital input for the increase trigger.
- **Repeat delay**
 - The repeat delay in milliseconds (ms) between steps.

NOTE The **Input +** and **Input -** digital inputs are the same for all regulation modes, but only affect the regulation modes in which they were enabled.

For **Analogue input set point** reference:

Select the analogue input to use:

- AIN1
- AIN2
- AIN3
- AIN4

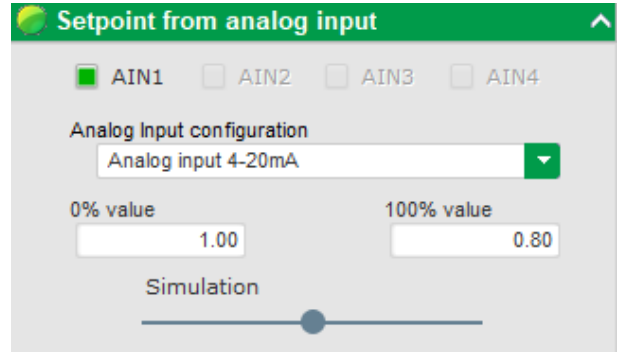

Select the analogue input configuration:

- 0/10 V
- +/-10 V
- 4-20 mA
- POT (Potentiometer)

NOTE The power factor reference terminals could be swapped if needed. For example, the minimum power factor for 100% of the analogue input, and the maximum power factor for 0% of the analogue input.

Use the **Simulation** selection to see the power factor reference (blue line) on the capability diagram displayed at the right.

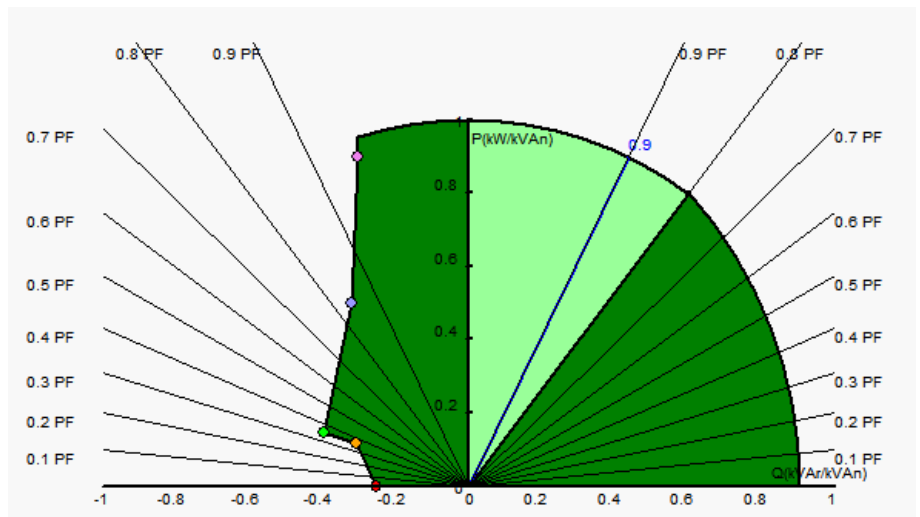

NOTE This capability diagram is fictitious because it describes evolution of the power factor at one point of the grid, not at the alternator terminals.

5.5.8 Field current (manual mode)

This regulation is used to control the value of the field current directly.

It is mainly used during commissioning or as fallback mode if a measurement is incorrect on the AVR (alternator voltage measurement or alternator current measurement).

It takes priority over all the other regulation modes that might be active.

The reference point is configured by either:

- An **Internal set point** fixed reference.
- An **Analogue input** set with a range.

If a value is configured this value can be changed with the CAN bus.

Enable field current regulation by selecting the activation type from the drop-down list:

- Controlled by a digital input (**DI1 to DI8**)
- **Always enabled**

NOTE If **None** is selected, field current regulation is never enabled or is enabled by a logic gate.

For **Internal set point** (home preference) :

Configure the reference set point value.

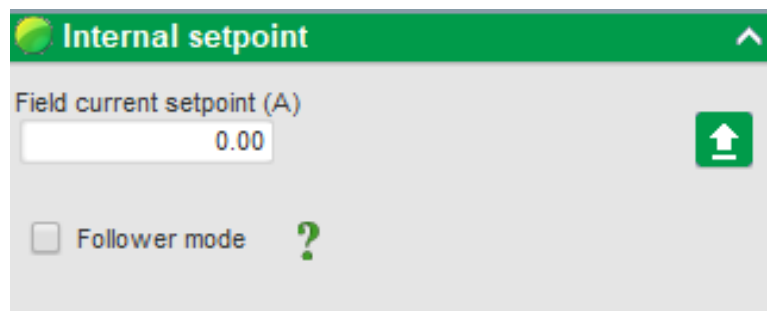
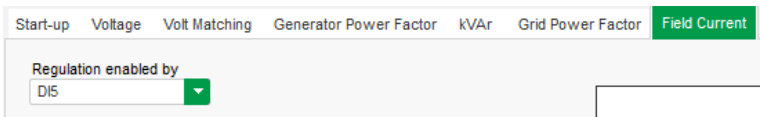

You can enable **Follower mode** (tracking function), when switching from a regulation mode to manual mode. This allows the field current measurement to be used as a reference and prevents any visible jumps in the operating point of the machine.

NOTE **Follower mode** can only be used if the **Internal set point** (home reference) is fixed.

The **Internal set point** (home reference) can be changed by configuring the **Set point adjustment**.

Set point adjustment: *

The set point can be adjusted with a **Step +/- IF (A)** value to either increase or decrease the reference.

Digital inputs are used to trigger the increase or decrease.

A **Repeat delay**, in milliseconds (ms), gives a delay between the next increase or decrease applying.

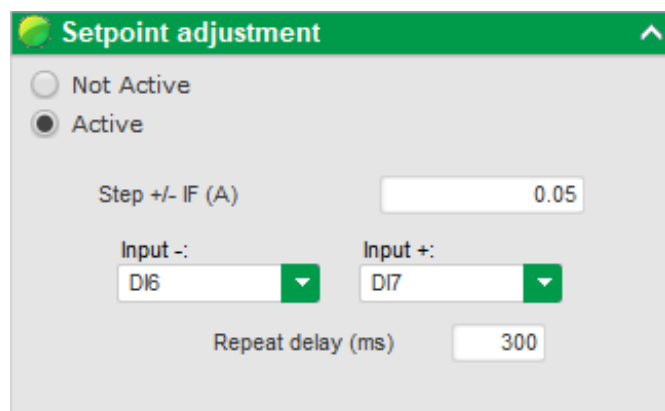

NOTE * **Set point adjustment** is only available to configure when used with the **Internal set point** reference. This option is not available when using an analogue input for the set point.

To use the set point adjustment, select **Active** and configure the values:

- **Step +/- IF (A)**
 - Value used for either increase (**Input +**) or decrease (**Input -**)
- **Input -**
 - The digital input for the decrease trigger.
- **Input +**
 - The digital input for the increase trigger.
- **Repeat delay**
 - The repeat delay in milliseconds (ms) between steps.

NOTE The **Input +** and **Input -** digital inputs are the same for all regulation modes, but only affect the regulation modes in which they were enabled.

For **Analogue input set point** reference:

Select the analogue input to use:

- AIN1
- AIN2
- AIN3
- AIN4

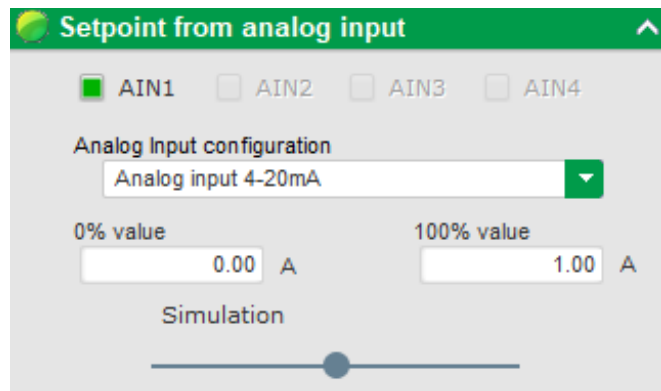

Select the analogue input configuration:

- 0/10 V
- +/-10 V
- 4-20 mA
- POT (Potentiometer)

Configure the current reference for 0 % and 100 % values.

NOTE The current terminals could be swapped if needed. For example, the minimum field current for 100% of the analogue input, and the maximum field current for 0% of the analogue input.

Use the **Simulation** selection to see the corresponding value of the field current reference (blue line) displayed at the right.

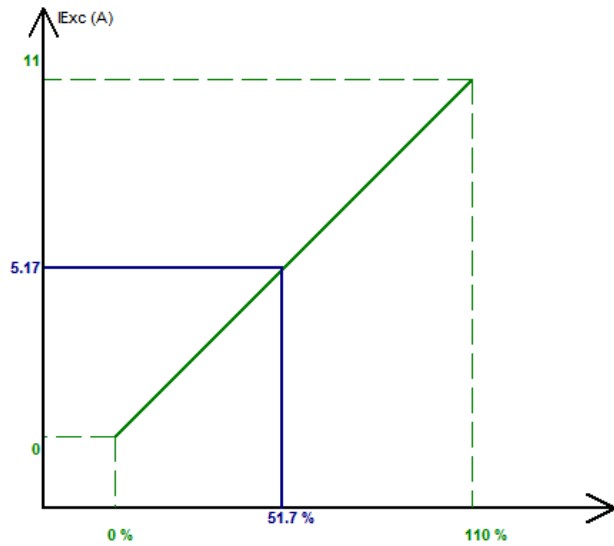

5.6 PID settings

Configure the PID gains.

The settings for the PID in the DVC 550 must be used after the nominal settings have been made.

The PID settings shown are not final settings, but can be used as a starting point for the DVC 550 voltage regulation. Further tuning will be needed for the type of alternator present.

Regulation loop speed can be modified according to the response time of the generator, between 2.5 ms and 20 ms in 2.5 ms steps. If this value is modified, it will be necessary to adjust PID gains.

	Voltage	Field current	PF/kVAR	Grid PF
Proportional	7.000	2.100	10	1
Integral	100	60	10	1
Derivative	500	15	0	0
Gain	100	100	100	100

Regulation loop speed: 0: 2.5 ms

Negative forcing ?

DC Bus voltage compensation ?

Select **Negative forcing** if the alternator operation requires various load steps. Whether adding and/or shedding (standalone operation or parallel machine operation).

This function briefly inverts the voltage at the exciter field terminals to minimise the time to recover the rated voltage to the rated voltage.

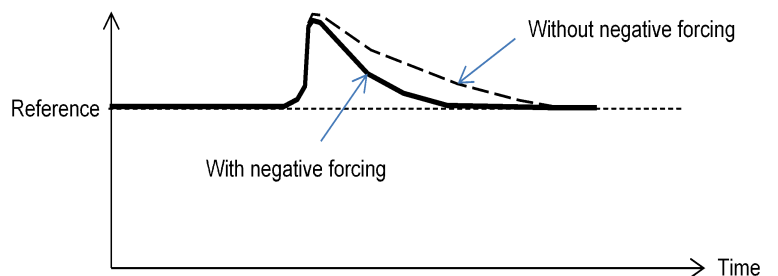

If a shunt or AREP type supply is being used, the power supply voltage depends directly on the voltage at the alternator terminals.

This can fluctuate with the load and therefore influence the PID's behaviour.

Select **DC Bus voltage compensation (VBus)** to compensate these fluctuations.

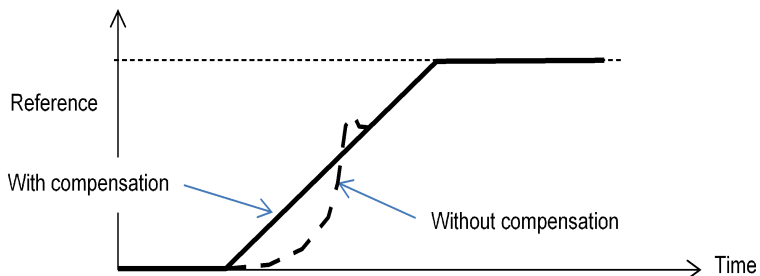

5.7 Inputs/outputs

You can configure additional inputs or outputs to those already configured for use in the regulation configuration.

Already configured inputs or outputs are shown greyed out.

Digital inputs (**DI**) or digital outputs (**DO**):

The configured type is display to the right of the screen (relay or transistor).

Digital Inputs		
Digital Input	Active	Destination
DI1	Active Low	None
DI2	Active Low	None
DI3	Active Low	Volt Matching Regulation
DI4	Active Low	None
DI5	Active Low	Field Current Regulation
DI6	Active Low	Down Adjustment
DI7	Active Low	Up Adjustment
DI8	Active Low	None

Digital Outputs		
Source	Active	Digital Output
None	Active Low	DO1
None	Active Low	DO2
None	Active Low	DO3
None	Active Low	DO4
None	Active Low	DO5
None	Active Low	DO6
None	Active Low	DO7
None	Active Low	DO8
None	Active Low	DO9
None	Active Low	DO10

Digital input (DI)

Active setting:

- **Active low**
 - Closed if the condition is fulfilled.
- **Active high**
 - Open if the condition is fulfilled

Destination setting:

- The input is used to activate or deactivate the feature selected.

Digital output (DO)

Active setting:

- **Active low**
 - Closed if the condition is fulfilled.
- **Active high**
 - Open if the condition is fulfilled

Source setting:

- The output is driven by the state of the feature selected.

Analogue inputs (**AI**) or analogue outputs (**AO**):

The **analogue inputs/outputs** can be configured by defining the source, the configuration and the 0% and 100% values.

Analog Inputs/Outputs									
ID	Configuration AI	Destination	0% value	100% value	Source	Configuration AO	0% value	100% value	
AI01	4-20mA	None	0.00	0.00	None	None	0	0	
AI02	0-10V	None	0.00	0.00	None	None	0	0	
AI03	0-10V	None	0.00	0.00	None	None	0	0	
AI04	0-10V	None	0.00	0.00	None	None	0	0	

Analogue input (AI)

Select the input type:

- 0-10 V
- +/-10V
- 4-20mA
- POT (Potentiometer)

Destination setting:

- The input is used to activate or deactivate the feature selected.

Configure the 0 % and 100 % values.

You can also configure if the analogue input should maintain the value during a wire break.

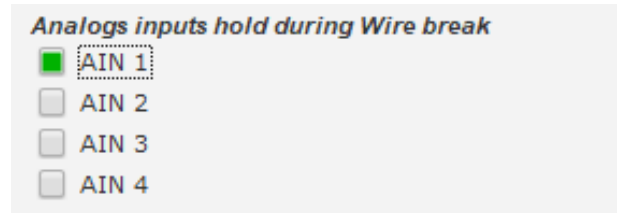

Analogue output (AO)

Select the output type:

- 0-10 V
- +/-10V
- 4-20mA
- POT (Potentiometer)

Source setting:

- The output is driven by the state of the feature selected.

Configure the 0 % and 100 % values.

5.8 Curve functions

Curve functions are used to control a parameter as a function of another parameter.

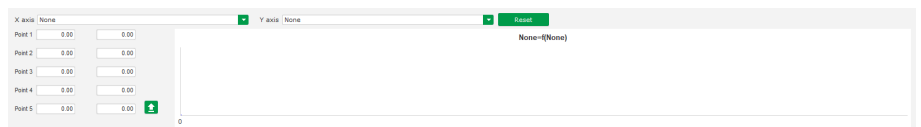

Example use for curve functions:

- The kVAr reference as a function of the voltage during kVAr regulation.
- The maximum stator current as a function of the stator temperature.
- The maximum field current as a function of the temperature or an analogue input.
- The voltage reference as a function of the speed.
- The field current as a function of the active power.
- Specific scaling.

For a curve function to work, the **X axis** and **Y axis** parameters must be configured, and the set of 5 points plotted.

NOTE These functions are active as soon as the curve is created.

Select **Reset** to clear the curve settings.

Example 1

Reactive power reference as a function of the grid voltage for a 400 V machine.

X axis: Bus Average Voltage (Ph-Ph) | Y axis: Reactive power setpoint | **Reset**

Point 1	384.00	1,400.00
Point 2	389.00	0.00
Point 3	400.00	0.00
Point 4	415.00	0.00
Point 5	420.00	-1,400.00

Reactive power setpoint=f(Bus Average Voltage (Ph-Ph))

A voltage value lower than the one defined at point 1, the reactive power reference is held at the value defined at point 1.

A voltage value higher than the one defined at point 5, the reactive power reference is held at the value defined at point 5.

Example 2

Field current reference as a function of the temperature measured at the stator (in this example temperature 1).

X axis: PT100#1 Temperature | Y axis: Generator rated nominal field current | **Reset**

Point 1	-30.00	3.50
Point 2	0.00	3.00
Point 3	10.00	2.50
Point 4	25.00	2.00
Point 5	30.00	1.50

Generator rated nominal field current=f(PT100#1 Temperature)

For a low temperature, increase in the field current is then allowed.

5.9 User PID gain

This page configures an independent PID which can be used to regulate another component.

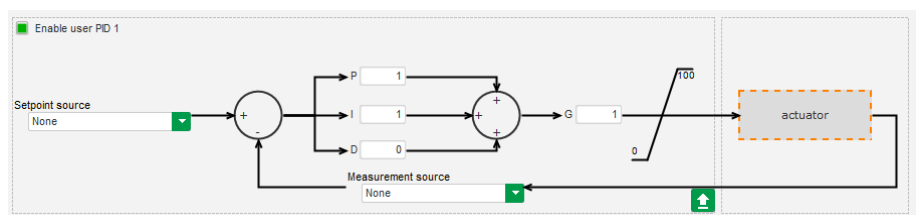

5.10 Logic/analogic gates

Change type of logic gate

Change the type of gate by selecting the gate symbol:

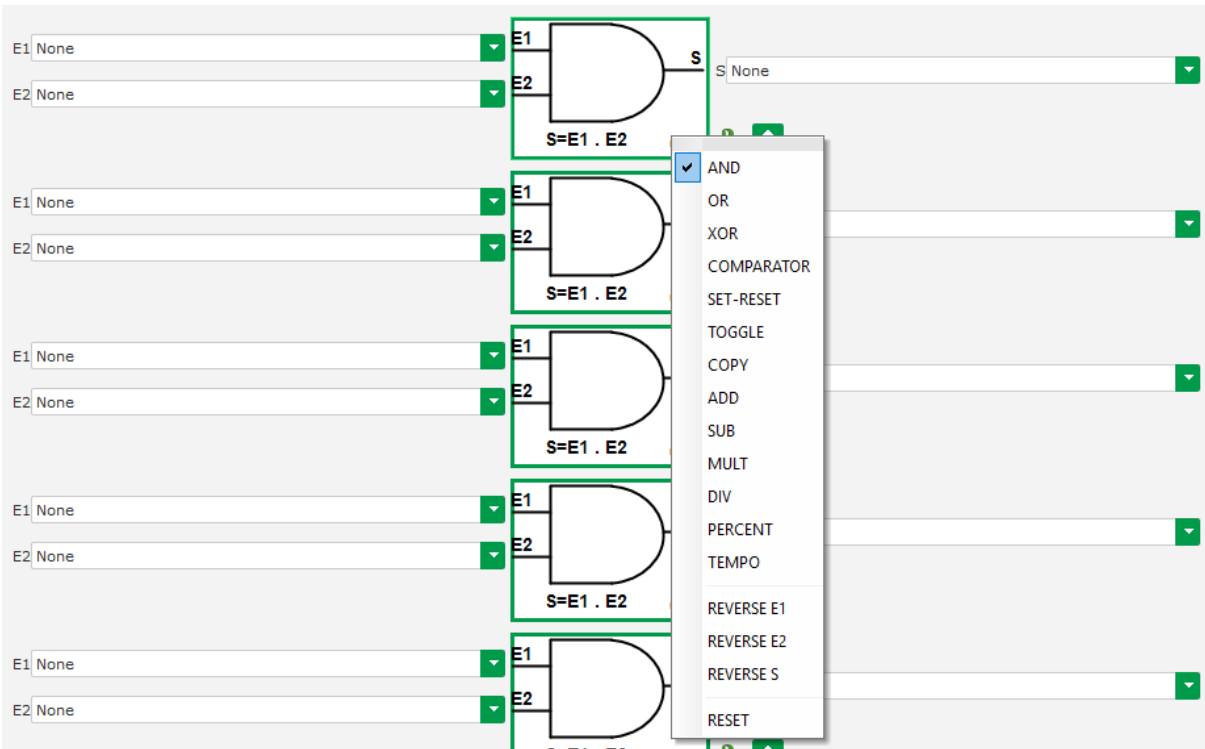

Enlarge parameter list selection

To make the parameter list larger, select and drag from the bottom right of the list:

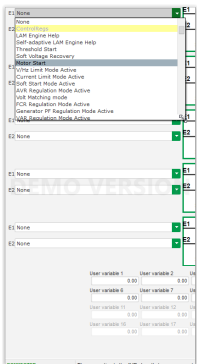

To quickly select a parameter, enter the first few letters in the drop-down list.

Link logical gate functions

Link the functions in sequence and use an output from a previous function as an input condition.

Select the input **Function # state**, where # is the number of the logic function to use for input.

Reverse input or output values

The input values **E1** or **E2** and the output value **S** can be reversed. Not all types of logic gate can be reversed.

A white circle is shown on the logic gate symbol for reversed inputs or output.



Example AND gate with E1 reversed

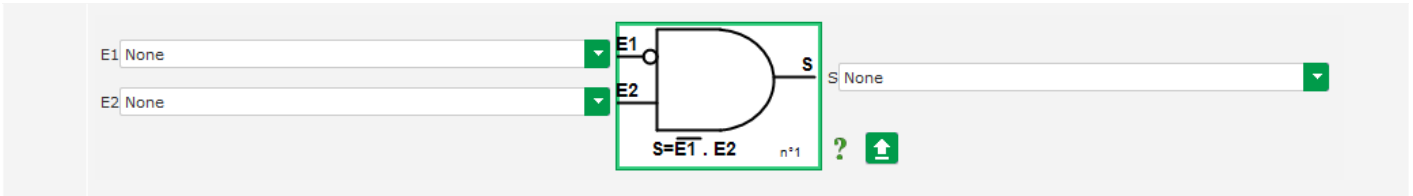

To reverse **E1**, **E2** or **S**, select the logic gate and use the **REVERSE** option. *

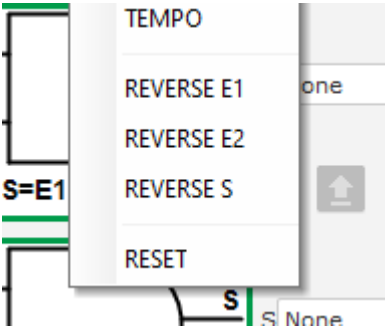

Logic gate truth help ?

Use the help option next to the logic gate to display the truth table for that type of gate. The truth tables does take into account if any reversals have been applied to either input or output.

E1	E2	S
0	0	0
0	1	0
1	0	0
1	1	1

Reset logic gate

To reset a logic gate, select the symbol and use **RESET**.

Examples



Start the AVR on power supply voltage threshold

When the power is switched on, the power supply voltage increases. A threshold should therefore be set above which the ramp will be able to be executed. A user-defined variable is used.

Use the **COMPARATOR** gate with the following variables:

- E1 : Internal power supply Volts
- E2 : User variable 1 *, set at 10 (DC bus 10 V)
- S : Starting

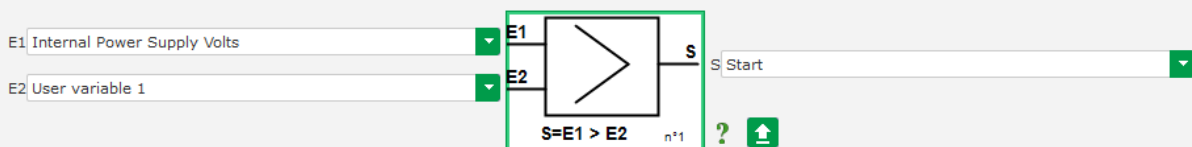

NOTE * The value of **User variable 1** depends on the voltage your field excitation system can be provided by the residua magnetization. In this example we used 10 V.



kVAR regulation for a load less than 10% of the rated power (connected to the grid)

When the machine is connected to the grid, without a load being present, instabilities can appear due to the stator current measurement interference. We therefore recommend kVAR regulation if the active power is less than 10% of the alternator rated power.

Use the **COMPARATOR** gate with the following variables:

- E1 : User variable 2, set at 10 (10% reactive power)
- E2 : Real power percentage
- S : VAR regulation

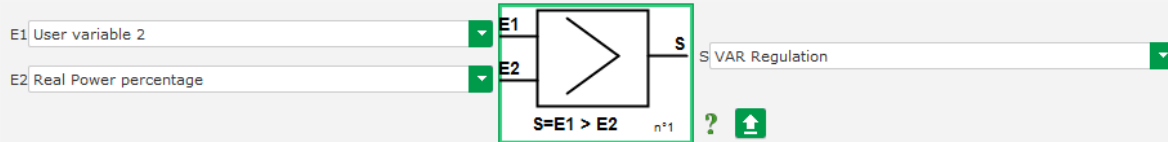

Pulse Start and Stop

The regulation function is switched on by a maintained input. As soon as this input changes state, field excitation is stopped. Pulsed starting and stopping can be configured using a SET-RESET gate:

Use the **SET-RESET** gate with the following variables:

- E1 : DI1, which sends the start pulse
- E2 : DI2, which sends the stop pulse
- S : Starting

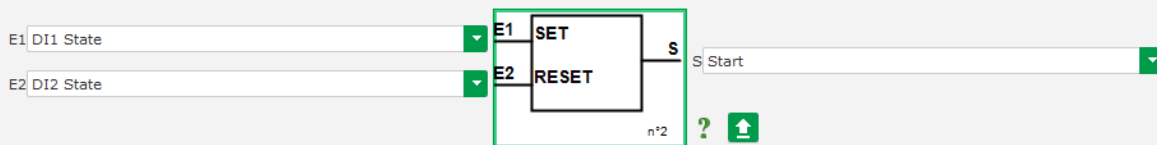

5.11 Synchronization

With the grid code voltage measurement wired, the DVC 550 is capable of running the grid synchronization sequence.

Check that the phase order is correct as the DVC 550 does not automatically do this.

Check that the grid and the generator have the same measurement type (single-phase, or three-phase).

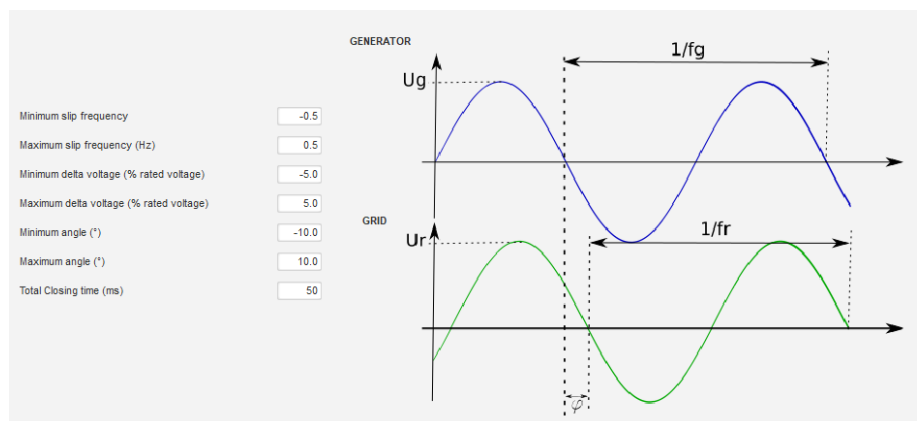

The frequency, voltage and phase angle ranges must be configured. These must be complied with so that connection can take place without damaging the machine.

The closing time of the circuit breaker between the alternator and the grid must also be configured.

This ensures that synchronization can be performed and completed before leaving of the configured connection zone.

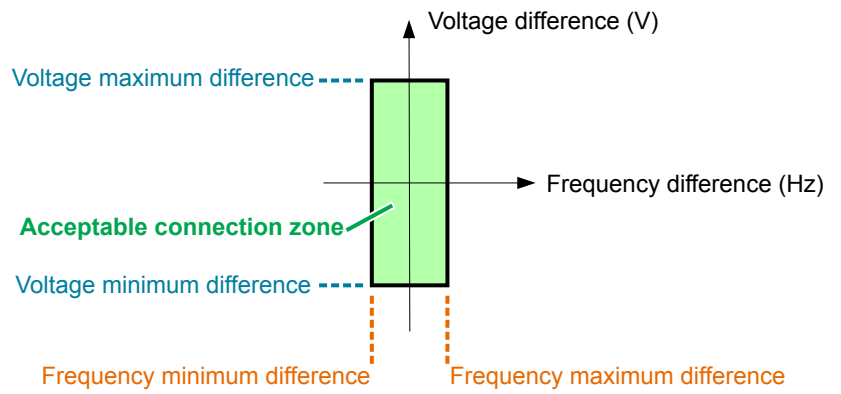

The synchronization sequence is controlled by a parameter which is kept active (controllable from an input, communication, or a logic gate).

The possible synchronization pulse remains active as long as the frequency difference and voltage difference are in the range defined by the upper and lower limits. A signal should therefore be provided for closing the grid connection contractor.

The frequency difference can be used to control an analogue output to inform the genset controller (or any other control device) that the driving system frequency needs to be increased or decreased. The parameters are configured on the Input/outputs page.



Example

An example for a frequency difference between - 0.5 Hz and + 0.5 Hz:

Analog Inputs/Outputs

ID	Configuration AI	Destination	0% value	100% value	Source	Configuration AO	0% value	100% value
AIO1	4-20mA	None	0.00	0.00	Delta frequency for synchronisation	+/-10V	-0.5	0.5
ΔIO2	0-10V	None	0.00	0.00	None	None	0	0

This corresponds to the following diagram:

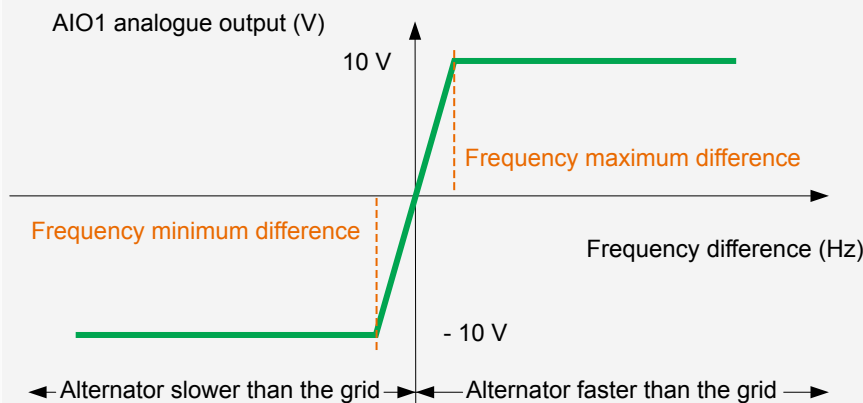

5.12 Grid code

5.12.1 Grid code

The grid code function provides one or more protection faults to be detected could come from the grid. For example, LVRT events (Low Voltage Ride Through) or FRT events (Fault Ride Through), which can damage the generator.

The DVC 550 has 3 functions:

- Grid code profile monitoring
- Maximum stator current monitoring

- Voltage measurement monitoring for grid code fault

You can also save parameter values, for example generator voltage measurement, generator current measurement or internal angles.

5.12.2 Profile monitoring

Select **Enable grid code profile monitoring** to activate this mode.

Configure the values of the profile, imposed by the grid code standard applied in the location where the DVC 550 is implemented.

It monitors that the generator voltage is always at least greater or equal to the value given in the profile, as soon as the grid code event is started.

If the voltage is lower than the value determined by the profile, the fault flag is activated.

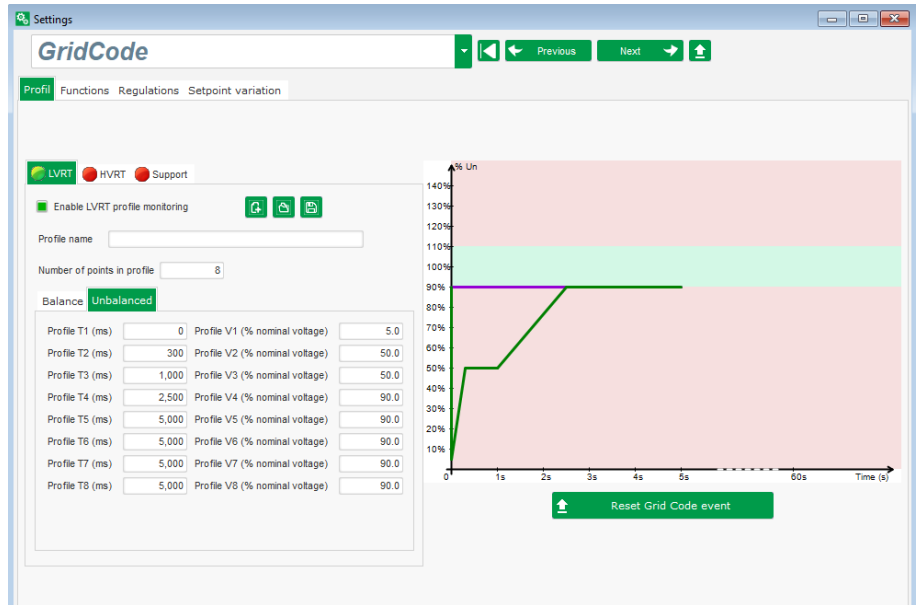

The state of this monitoring can be output as a digital output and also used in logical functions.

In this example the fault is addressed on output DO2 in Inputs/Outputs page.

Digital Outputs		
Source	Active	Digital Output
None	Active Low	DO1
State of grid code profile monitoring	Active Low	DO2
None	Active Low	DO3

5.12.3 I stator Max (stator current monitoring)

Select **Enable I stator Max** to activate this mode.

Enable I stator Max

I stator maximum coeff

Configure the value for maximum current that the generator can withstand (in times of rated stator current).

Such an over current can occur when the grid recovers after a grid code fault, if the difference between angular position of the rotor and electric angle is too high.

The measure of over-current is realized with a dedicated CT connected on Grid code CT input. Values for the primary and the secondary have to be set on the **Wiring** page.

NOTE As the over-current is very fast, the fault status will not be an auto reset fault.

The over-current state can be output as a digital output and also used in logical functions.

In this example the fault is addressed on output DO2 in Inputs/Outputs page.

Digital Outputs		
Source	Active	Digital Output
None	Active Low	DO1
Max I stator detection state	Active Low	DO2
None	Active Low	DO3

Grid code current measurement

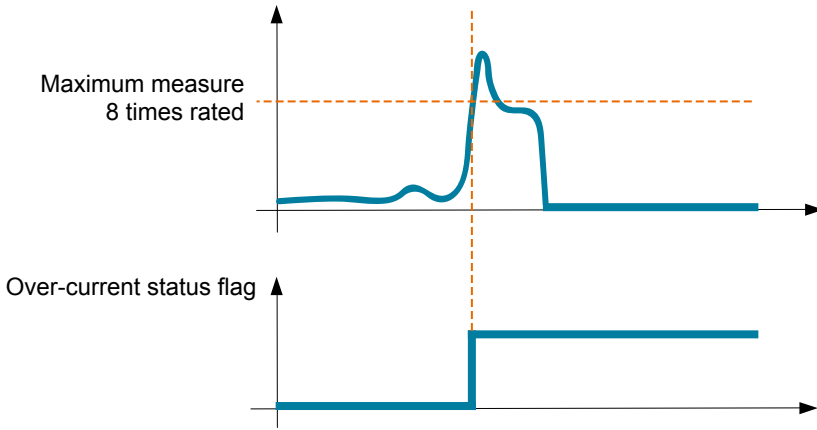

5.12.4 Voltage monitoring in PF mode

Select **Enable voltage monitoring in PF mode** to activate this mode.

Configure:

- A delay (ms) before switching to voltage mode.
- Voltage difference (%) of rated grid voltage.
- Grid rated voltage (V)

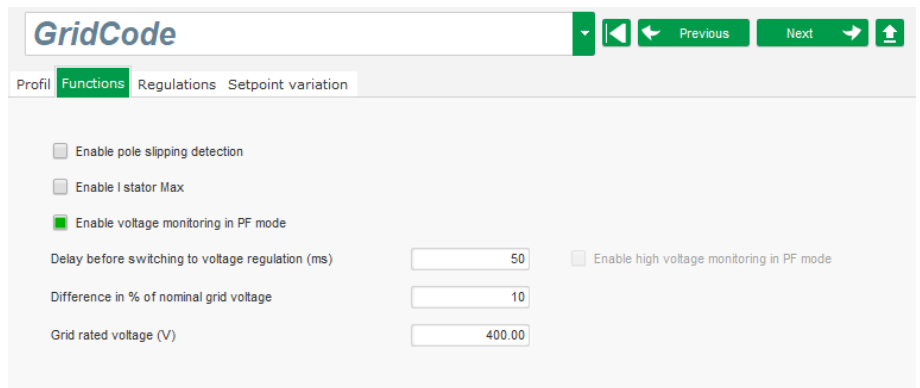

When the measured voltage is outside the predefined range, the voltage regulation mode is activated and enables to sustain the grid by absorbing or producing reactive power, for example, with a difference of 10%:

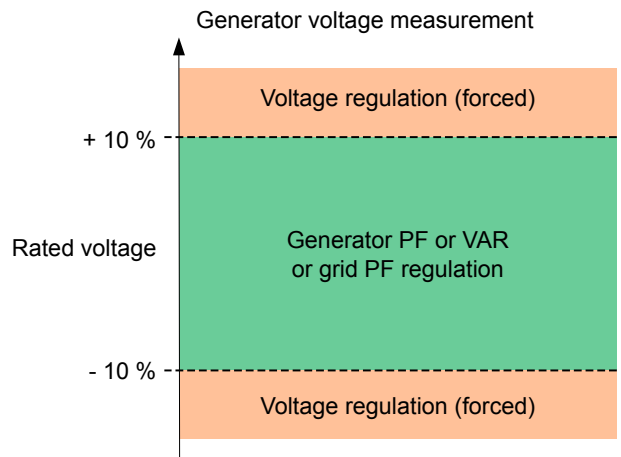

The state of this monitoring can be output as a digital output and also used in logical functions.

In this example the fault is addressed on output DO2 in Inputs/Outputs page.

Digital Outputs		
Source	Active	Digital Output
None	Active Low	DO1
Voltage monitoring state	Active Low	DO2

5.13 Log event

Select **Enable** for a log event to count the amount of events that are detected.

For an enabled event, the excitation current is recorded.

Log event

Previous Next

Enabled / Disabled	Event	Event counter	lexc during last loss of sensing fault detected
<input type="checkbox"/>	Enable overvoltage fault detected log	0	0
<input type="checkbox"/>	Enable undervoltage fault detected log	0	0
<input type="checkbox"/>	Enable overfrequency fault detected log	0	0
<input type="checkbox"/>	Enable underfrequency fault detected log	0	0
<input type="checkbox"/>	Enable open diode fault detected log	0	0
<input type="checkbox"/>	Enable short diode fault detected log	0	0
<input type="checkbox"/>	Enable reverse active power fault detected log	0	0
<input type="checkbox"/>	Enable reverse reactive power fault detected log	0	0
<input type="checkbox"/>	Enable PT100 1 alarm detected log	0	0
<input type="checkbox"/>	Enable PT100 1 fault detected log	0	0
<input type="checkbox"/>	Enable PT100 2 alarm detected log	0	0
<input type="checkbox"/>	Enable PT100 2 fault detected log	0	0
<input type="checkbox"/>	Enable PT100 3 alarm detected log	0	0
<input type="checkbox"/>	Enable PT100 3 fault detected log	0	0
<input type="checkbox"/>	Enable PT100 4 alarm detected log	0	0
<input type="checkbox"/>	Enable PT100 4 fault detected log	0	0
<input type="checkbox"/>	Enable PT100 5 alarm detected log	0	0
<input type="checkbox"/>	Enable PT100 5 fault detected log	0	0
<input type="checkbox"/>	Enable fault detected log	0	0
<input type="checkbox"/>	Enable CTP 1 fault detected log	0	0
<input type="checkbox"/>	Enable CTP 2 fault detected log	0	0
<input type="checkbox"/>	Enable CTP 3 fault detected log	0	0
<input type="checkbox"/>	Enable CTP 4 fault detected log	0	0
<input type="checkbox"/>	Enable CTP 5 fault detected log	0	0
<input type="checkbox"/>	Enable loss of sensing fault detected log	0	0
<input type="checkbox"/>	Enable unbalanced voltage fault detected log	0	0
<input type="checkbox"/>	Enable unbalanced current fault detected log	0	0
<input type="checkbox"/>	Enable short circuit fault detected log	0	0
<input type="checkbox"/>	Enable IGBT fault detected log	0	0
<input type="checkbox"/>	Enable motor start fault detected log	0	0
<input type="checkbox"/>	Enable power bridge overload fault detected log	0	0
<input type="checkbox"/>	Enable main field overload detected log	0	0
<input type="checkbox"/>	Enable main field overheating detected log	0	0
<input type="checkbox"/>	Enable stator overload detected log	0	0
<input type="checkbox"/>	Enable stator overheating detected log	0	0
<input type="checkbox"/>	Enable battery under voltage detected log	0	0
<input type="checkbox"/>	Enable CAN under voltage detected log	0	0

Event reset

5.14 Second Configuration

This function is usually known as the **50/60Hz switch function**, but it offers many more features and flexibilities.

Second configuration

Previous Next

Your modifications will be take account on the next power on of the regulator.

Second configuration enable 2nd configuration driving by DI1

Analog parameters type

Parenter id	Destination	Configuration 1 value	Configuration 2 value
1	V/Hz knee frequency	50	50
2	Voltage setpoint	0	400
3	V/Hz slope	0	1.5
4	None	0	0
5	None	0	0
6	None	0	0
7	None	0	0
8	None	0	0
9	None	0	0
10	None	0	0
11	None	0	0

Switch parameters type

Parameter id	Destination	Configuration 1 value	Configuration 2 value
12	None		
13	None		
14	None		
15	None		
16	None		

Second configuration enable 2nd configuration driving by DI1

To activate this feature, select **Second configuration enable**.

Select the digital input to activate the second configuration. *

NOTE * The activation of the digital input leads the switching to the second configuration and its deactivation brings the regulation back to the base configuration.

The switch is only taken into account at the start of regulation. Any activation or deactivation when the regulator is in operation will be ignored.

Select the parameters which will be affected when switching to the second configuration.

In the example above, we define a new:

- **Knee frequency** at 50 Hz.
- **Voltage set point** at 400 V.
- **V/Hz slope** set to 1.5.

6. Configure the DVC 550 with AGC

6.1 About the DVC 550 with the AGC-4

6.1.1 Software and hardware versions

The information in this document corresponds to the following software and hardware versions.

Table 6.1 Supported versions

Item	Details	Version
AGC-4	Supported product	4.75.x or later
DVC 550		Hardware: Rev. A Firmware: 1.1
DEIF EasyReg Advanced	Utility software	1.0.6.x or later

6.1.2 Introduction

CAN bus

The AGC-4 uses CAN bus to communicate with the DVC 550, additional DEIF controllers, and other equipment.

Always use twisted pairs, shielded cables (120 ohm impedance) of good quality for the CAN bus communication, such as Belden 3105A or Unitronic Bus CAN.

Parameter settings

Many settings for the DVC 550 can be directly configured from the AGC-4.

Some other settings can only be configured by using the **DEIF EasyReg Advanced** utility software.

Parameters controlled by the AGC-4 are greyed out in the DEIF EasyReg Advanced utility software. These parameters must be configured with the AGC-4 utility software.

Shared AGC-4 parameters on mixed DVC 310 and DVC 550 applications

In applications with both AGC-4s and DVC 550s together with AGC-4s and DVC 310s, some of the parameters are no longer shared between the AGC-4s. These parameters must be configured in each group of controllers.



More information

See **Mixed applications** in the section **Common DVC 550 settings** for information on a mixed application and the shared parameters.

The first time you set up a DVC 550, the **DEIF EasyReg Advanced** software must be used, and the CAN bus communication between the AGC-4 and the DVC 550 should not be connected.



More information

See **Get started with DEIF EasyReg Advanced** in this document for information on downloading and installing the utility software.

NOTICE

GENSET start

The genset should not be started before this manual states that it is allowed to start. This is to make sure that the protections and settings have been correctly configured.



More information

See **About the DVC 550** in this document for an overview of the DVC 550, the CAN bus port, LED indication, and other connections.

6.1.3 Factory settings

The AGC-4 is delivered from the factory with certain factory settings. These are based on typical values and are not necessarily the correct settings for matching the engine/generator set in question. Precautions must be taken to check the settings before running the engine/generator set.

6.1.4 Communication options

The AGC-4 can use several CAN bus ports to communicate with a number of other components. A system application could also include additional CIO modules.

The CAN bus communication is based on a J1939 protocol. Many Engine Control Units (ECUs) also communicate with the J1939 protocol, which means that the AGC-4 can communicate to the ECU and DVC 550 on the same CAN bus port.

If the AGC-4 is used in an application with a DVC 550 and a CANopen based ECU, the communication must be split into two different CAN bus ports on the unit. This can be done with the H12 dual CAN bus. The AGC-4 supports the CANopen engine interfaces: MTU-MDEC and MTU-ADEC.

The following examples can be helpful:

Description of application:	Settings:
Analogue GOV DVC 550 (Option H5.2)*	<ul style="list-style-type: none">• 2781 (Regulator output GOV): Analogue• 2783 (Regulator output AVR): EIC• 7565 (Digital AVR Interface): DEIF DVC 550• 7843 (CAN bus port C protocol): EIC
J1939-based ECU DVC 550 (Option H5.2)*	<ul style="list-style-type: none">• 2781 (Regulator output GOV): EIC• 2783 (Regulator output AVR): EIC• 7561 (Engine Interface): "Relevant J1939 protocol"• 7565 (Digital AVR Interface): DEIF DVC 550• 7843 (CAN bus port C protocol): EIC
J1939-based ECU DVC 550 DEIF CIO modules (Option H5.2)*	<ul style="list-style-type: none">• 2781 (Regulator output GOV): EIC• 2783 (Regulator output AVR): EIC• 7561 (Engine Interface): "Relevant J1939 protocol"• 7565 (Digital AVR Interface): DEIF DVC 550• 7843 (CAN bus port C protocol): EIC• 7891 (CIO Enable): ON
Analogue GOV DVC 550 DEIF CIO modules (Option H5.2)*	<ul style="list-style-type: none">• 2781 (Regulator output GOV): Analogue• 2783 (Regulator output AVR): EIC• 7565 (Digital AVR Interface): DEIF DVC 550• 7843 (CAN bus port C protocol): External modules DEIF• 7891 (CIO Enable): ON

Description of application:	Settings:
CANopen-based ECU DVC 550 (Option H12.2)* (DVC 550 mounted on CAN port D)	<ul style="list-style-type: none"> • 2781 (Regulator output GOV): EIC • 2783 (Regulator output AVR): EIC • 7561 (Engine Interface): “Relevant CAN Open protocol” • 7565 (Digital AVR Interface): DEIF DVC 550 • 7843 (CAN bus port C protocol): EIC • 7844 (CAN bus port D protocol): External modules DEIF
CANopen-based ECU DVC 550 DEIF CIO modules (Option H12.2)* (DVC 550 mounted on CAN port D)	<ul style="list-style-type: none"> • 2781 (Regulator output GOV): EIC • 2783 (Regulator output AVR): EIC • 7561 (Engine Interface): “Relevant CANOpen protocol” • 7565 (Digital AVR Interface): DEIF DVC 550 • 7843 (CAN bus port C protocol): EIC • 7844 (CAN bus port D protocol): External modules DEIF • 7891 (CIO Enable): ON

NOTE * The above examples use either option H5 or H12 mounted in slot number 2 (H5.2 or H12.2). The different setups will also work if H5 or H12 are mounted in slot number 8 instead (H5.8 or H12.8). If using slot number 8, then the parameters for the CAN port setup must be changed for the application.

NOTICE

Initial set up

During the initial setup of the DVC 550 with the DEIF EasyReg Advanced software, it is recommended to not have the CAN bus connected to the DVC 550.

6.2 Wiring the AGC-4 to the DVC 550

The AGC-4 uses CAN bus communication to the DVC 550 with the engine communication port via J1939.

CAN bus connector wiring

DVC 550

AGC-4

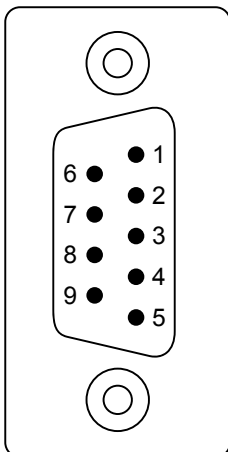

Terminal: 2 CAN Low
Terminal: 3 CAN Shield
Terminal: 7 CAN High

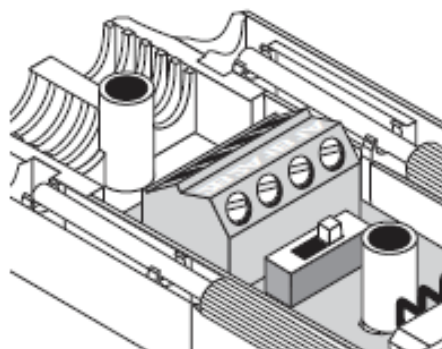

Terminal: 1C+ CAN-H
Terminal: 1C- CAN-L
Terminal: GND CAN-Shield

Check the setting of the terminal resistor when the wiring is done. It can be set to ON or OFF with the switch next to the terminals.

Figure 6.1 Recommended wiring to AGC-4

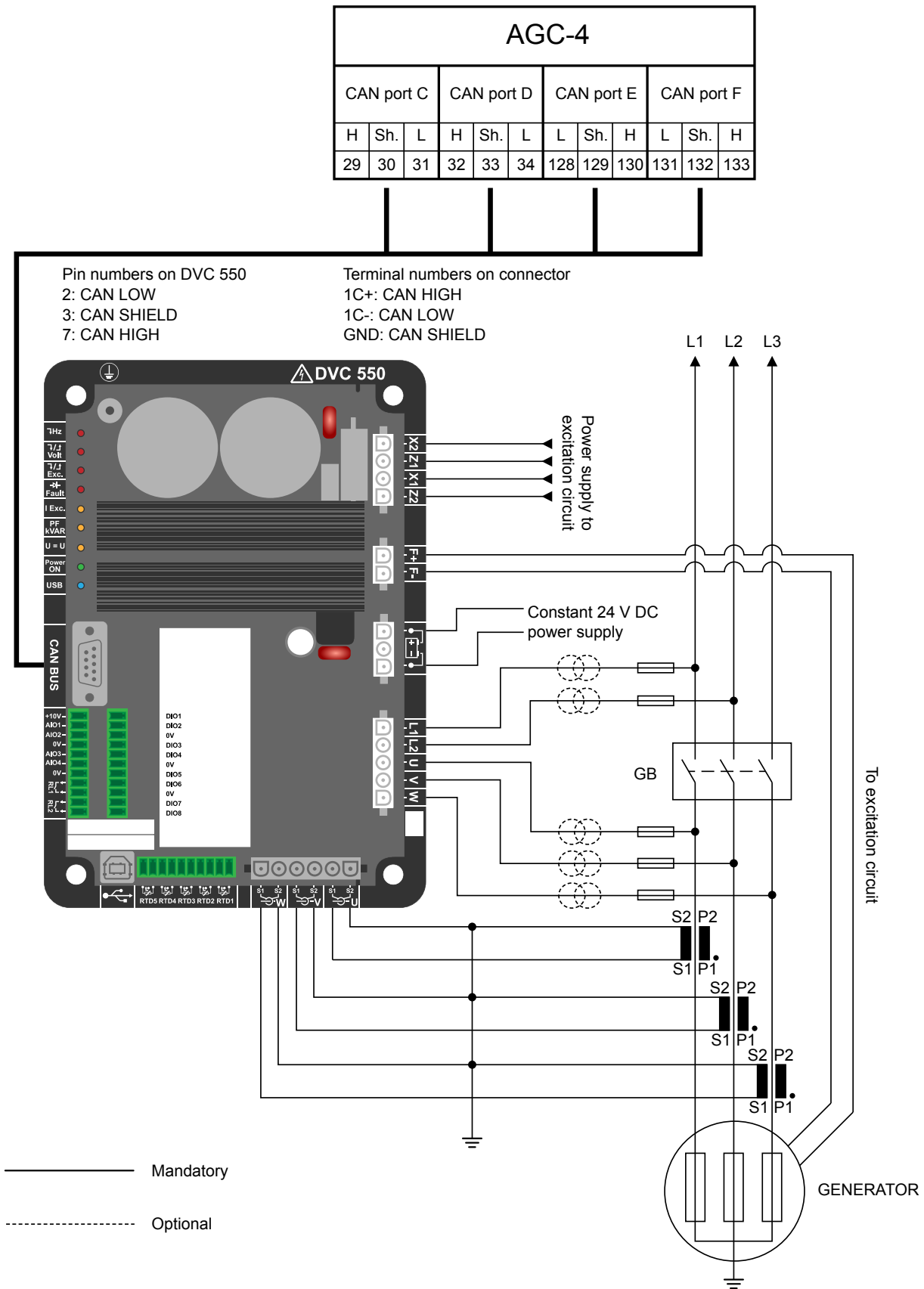

————— Mandatory
 - - - - - Optional

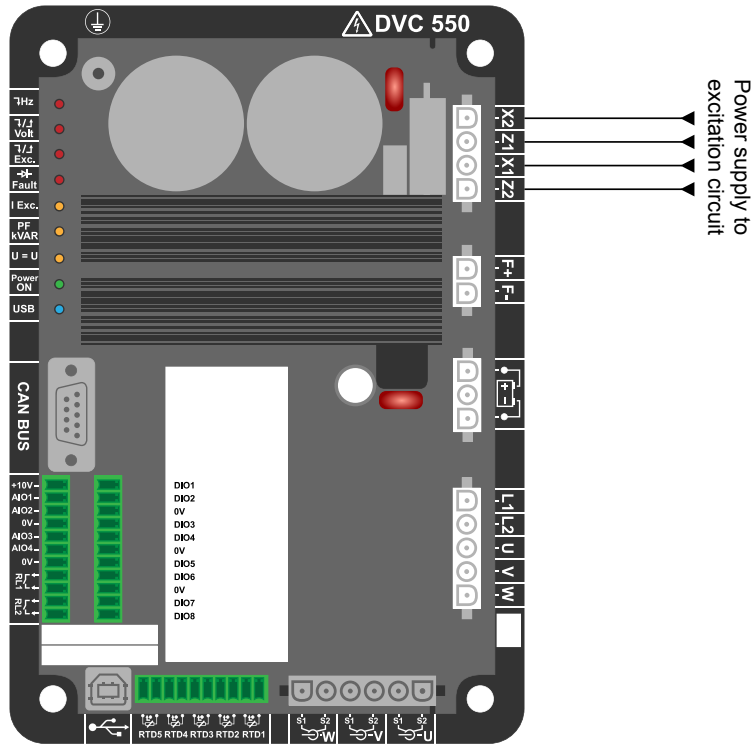

PMG

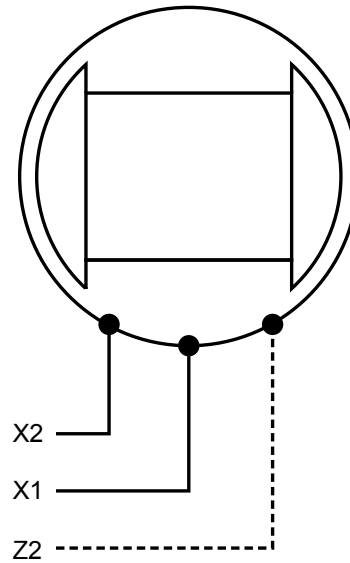

AREP feed

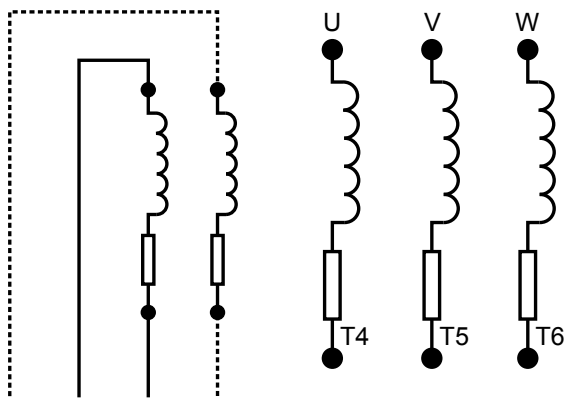

Shunt feed

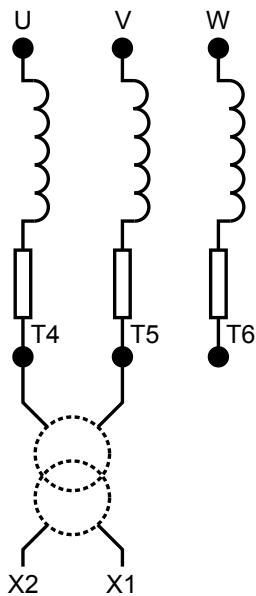

6.3 Configure the DVC 550

6.3.1 Connect and launch DEIF EasyReg Advanced

The DVC 550 is configured by using the **DEIF EasyReg Advanced** utility software.



More information

See **Get started with DEIF EasyReg Advanced** for more information about downloading, installing, connecting, and launching the utility software.

1. Connect the USB cable from your PC to the DVC 550.

2. Launch **DEIF EasyReg Advanced** from your PC.

- The DVC 550 indicates connection on the USB cable with a blue LED **USB** .
- The DVC 550 connection status is also shown in the bottom left of the **DEIF EasyReg Advanced** utility software.

3. Select **Expert** mode 

4. Select **New customized configuration** to create a new configuration.

- You can also reload a previously saved configuration by using **Open a file**.

5. The **Generator description** settings are now displayed.

6.3.2 Generator description

You can enter an application name for the project.

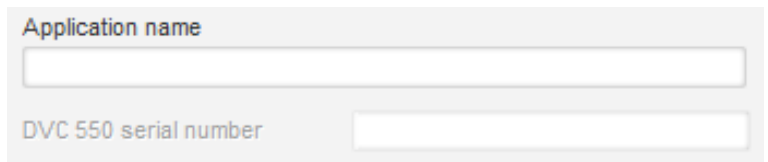

Application name

DVC 550 serial number

The serial number of the DVC 550 is also shown.

Generator data

Describe all the alternator characteristics: voltage (in Volts), apparent power (in kVA), frequency (in Hz), and power factor.

Fields: rated current, reactive power and active power are calculated automatically.

Pole ratio for diode fault (exciter poles number divided by generator poles number).

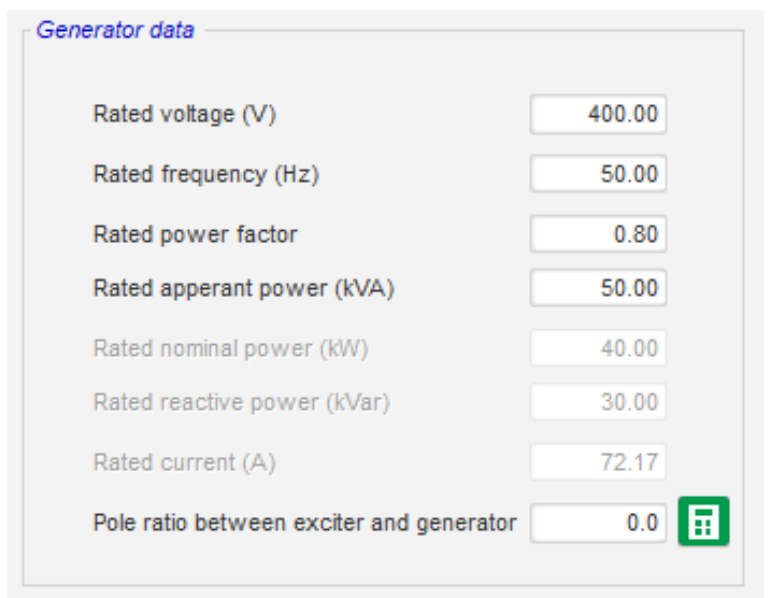

Generator data

Rated voltage (V)	<input type="text" value="400.00"/>
Rated frequency (Hz)	<input type="text" value="50.00"/>
Rated power factor	<input type="text" value="0.80"/>
Rated apparent power (kVA)	<input type="text" value="50.00"/>
Rated nominal power (kW)	<input type="text" value="40.00"/>
Rated reactive power (kVar)	<input type="text" value="30.00"/>
Rated current (A)	<input type="text" value="72.17"/>
Pole ratio between exciter and generator	<input type="text" value="0.0"/> 

Excitation data

Describe all the field excitation characteristics:

- Field inductor resistance (in Ohms) *
- Shutdown field current (in Amps)
- Rated field current (in Amps)

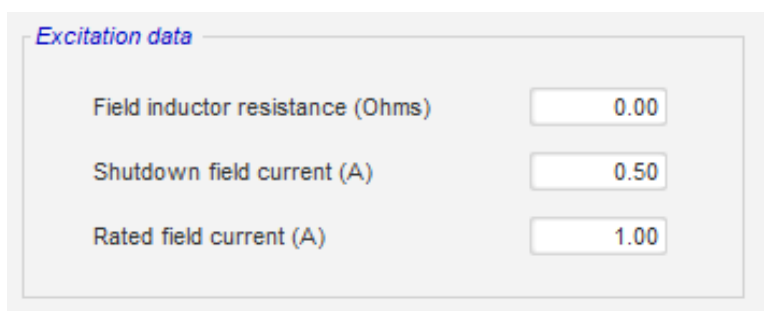

Excitation data

Field inductor resistance (Ohms)	<input type="text" value="0.00"/>
Shutdown field current (A)	<input type="text" value="0.50"/>
Rated field current (A)	<input type="text" value="1.00"/>

NOTE * This can be measured with a multimeter. Take the **F+** and **F-** wires of the terminals and measure the resistance through the excitation circuit on the alternator.

6.3.3 Wiring

Configure the wiring connections between the DVC 550 and the alternator.

The wiring preview changes according to the settings.

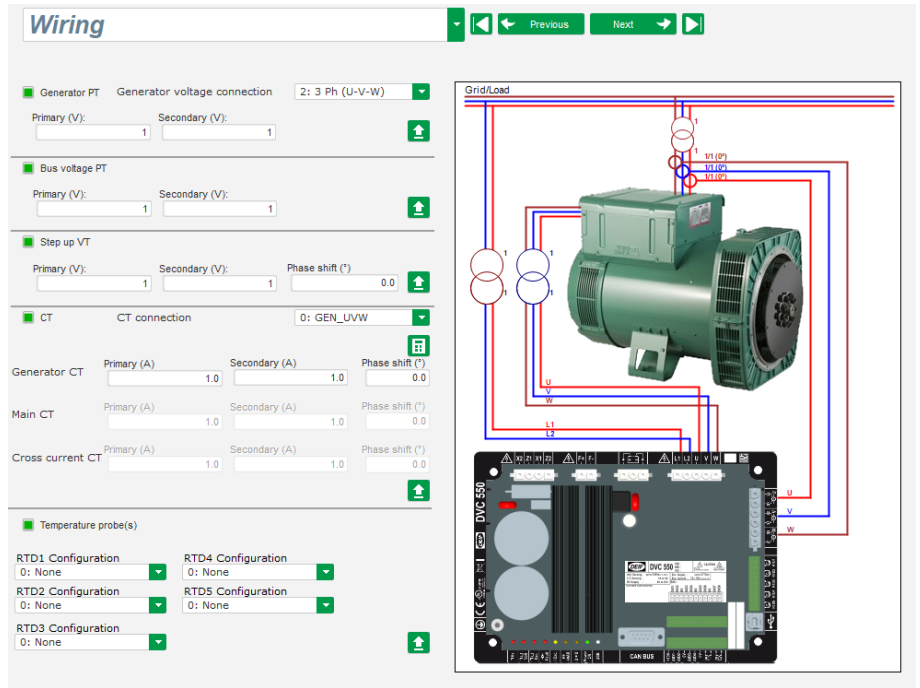

Alternator voltage measurement PTs

- State the primary and secondary winding voltages (in Volts).
- State the type of measurement: phase-neutral, phase-phase, 3 phases or 3 phases and neutral using the drop-down menu.

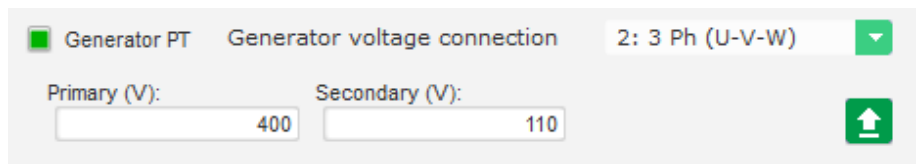

Alternator current measurement CTs

- State the primary and secondary winding currents (in Amps).
- Indicate the CT configuration using the drop-down menu.

NOTE The phase shift value should be set during tests and commissioning. It is used to compensate for the phase difference caused by the CTs and VTs.

If an isolation CT is present, the secondary parameter value should correspond to the isolation CT secondary.

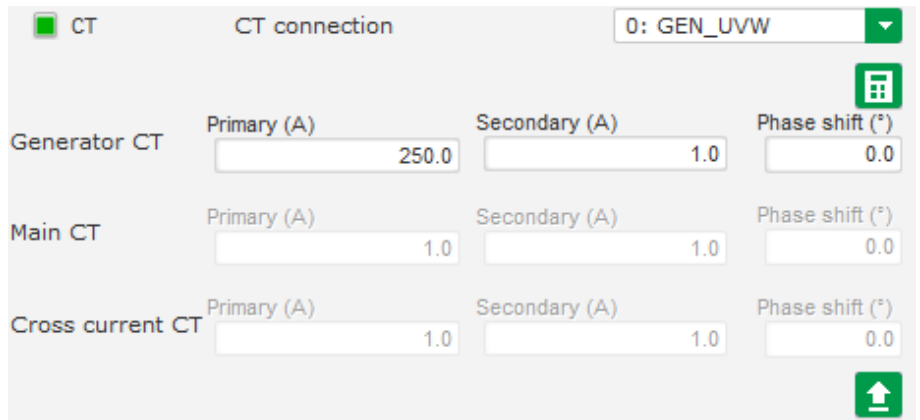

Bus voltage measurement VTs

- State the primary and secondary winding voltages (in Volts).

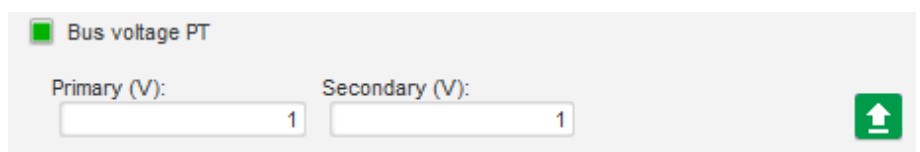

NOTE Main CT and Cross current CT are not for use with AGC-4.

Bus current measurement CT: Placed in the V phase

- If this is present, choose the 4 mode.
- State the primary and secondary winding currents in Amps).
- This input is also used for Grid code over current detection.

CT Type	Primary (A)	Secondary (A)	Phase shift (°)
Generator CT	250.0	1.0	0.0
Main CT	1.0	1.0	0.0
Cross current CT	1.0	1.0	0.0

Pt100 and PTC

- Select Pt100 or PTC inputs.

RTD Configuration	Value
RTD1 Configuration	0: None
RTD2 Configuration	0: None
RTD3 Configuration	0: None
RTD4 Configuration	0: None
RTD5 Configuration	0: None

6.3.4 Start up and tuning in DVC 550

To protect against over-voltage and over-current, make a shutdown alarm in the AGC-4 before tuning in the regulators.

NOTE The CAN bus communication between the AGC-4 and the DVC 550 should not be connected yet. It will be stated later in this document when this should be connected.

Before the first start of the genset with the DVC 550, make sure that the PWM for start-on threshold is set to 0 % and the **Activation threshold** set point is high, for example 90 % of nominal voltage. It is also a good idea to remove the excitation circuit supply (X1-X2-Z1-Z2) terminal connector.

Additionally, the **Soft-start** ramp should be set slow, for example 10 seconds, to ensure that a slow PID regulation is able to follow the ramp.

When the alarms, start-on threshold, and soft-start settings have been made, the genset is ready for the first start.

NOTE When the genset is started for the first time, it is presumed that all other equipment is tested, verified and tuned as desired. This manual is only relevant for when the DVC 550 is ready for the first start.

At the first start, only remanence voltage will be present, since the PWM is set to 0 %. This remanence voltage can be used to verify that the DVC 550 is able to measure alternator voltage correctly. This measurement should be compared to the genset controller's measured voltage and/or a multimeter reading.

The genset can then be stopped, and the PWM settings can be raised to, for example, 2 % (small steps), and the **Activation threshold** can be set to, for example, 15 % of nominal voltage. The user must verify that voltage is not shooting upwards, and the PWM can be raised until the alternator reaches **Activation threshold** voltage.

When the DVC 550 reaches this **Activation threshold**, the **Soft-start** ramp will now be used, up to the voltage set point.

When the voltage has reached the set point for the alternator, a transient test can be performed from the **Oscilloscope** window.



More information

See **Transient test** in **DEIF EasyReg Advanced, Oscilloscope** for more information about configuring a transient test.

For the first transient test, the voltage steps should only deviate about 2 % from the voltage set point.

With the result of the transient test, the regulation of the DVC 550 can now be verified, to see the regulation response.

It is now possible with the transient test to tune the DVC 550 regulation. When the sufficient response is acquired, the deviations for the transient test can be raised to +/- 5 % of the voltage set point.

Shown below is a transient test, which is considered reasonably tuned.

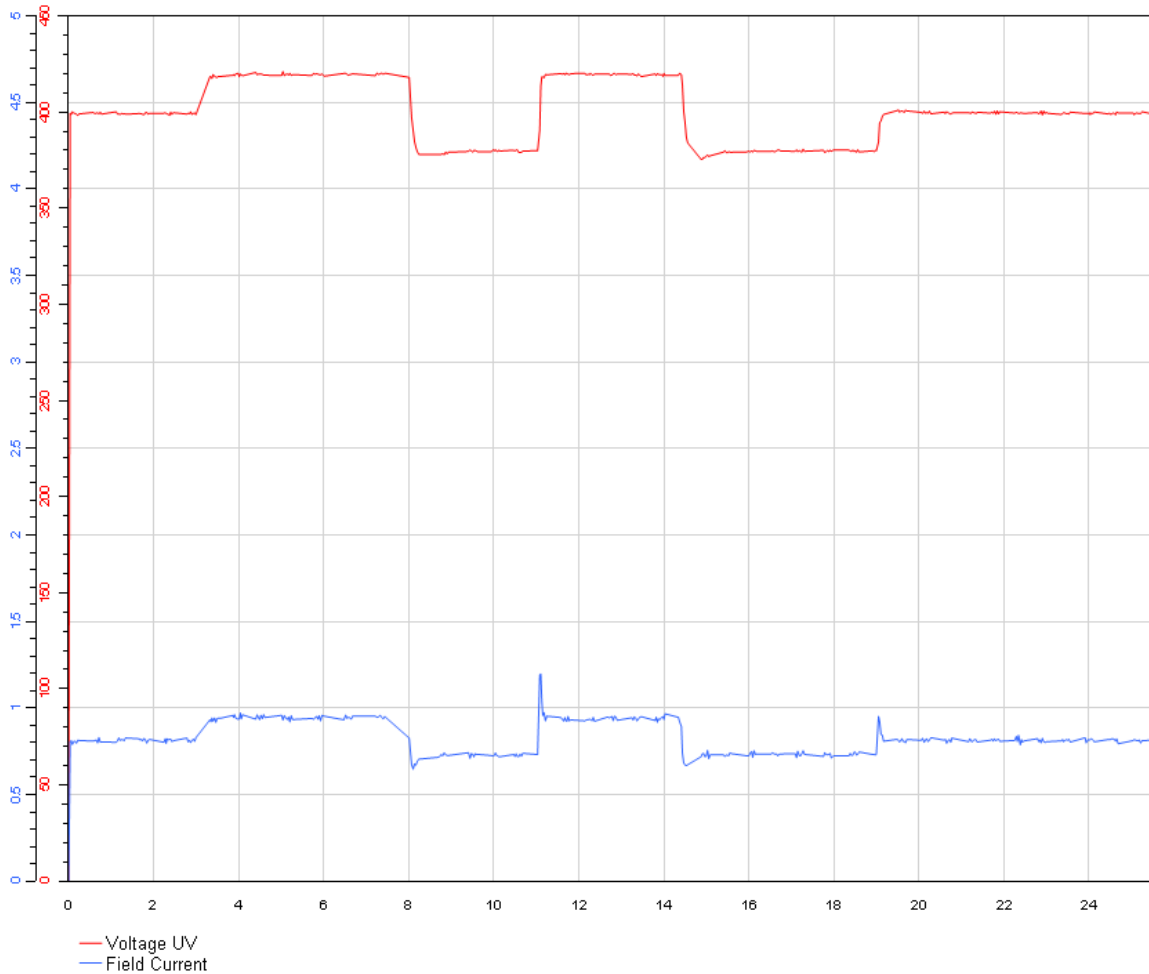

When the regulation has been tuned sufficiently, the **Soft-start** ramp can be tuned down until the user finds the start-up ramp fast enough.

The PWM percentage can be raised, until the first part of the ramp is fast enough for the user. The DVC 550's regulation is not active during start-on threshold. The PWM is a constant percentage of voltage that is led directly through the excitation circuit.

When the regulators and functions have been tuned in, the CAN bus cable between the AGC-4 and the DVC 550 can be connected.

It is recommended to go to parameter 7805 and set this to ON. Then the AGC-4 will be in control of the DVC 550, which makes it possible, for example, to switch regulation modes.



More information

When the CAN bus cable is connected between the AGC-4 and the DVC 550, see **Overview of shared parameters** and configure the settings for **Soft-start ramp**, **Start-on threshold**, **PWM** and other settings made during commissioning of the DVC 550. Make sure that the gain factor in DEIF EasyReg Advanced and the gain factor parameter 7801 are the same.

6.3.5 Configure AGC-4 to DVC 550 communication

For the AGC-4 to communicate with a DVC 550, these parameters must be configured by using *DEIF Utility software 3*.

DAVR controls (7805)

The DAVR control is enabled by default.

Parameter "DAVR controls" (Channel 7805)

Password level : customer

Enable
 High Alarm
 Inverse proportional

Auto acknowledge
Inhibits...
Write OK Cancel

Reg. output AVR (2783)

Select the regulation output AVR to be EIC on parameter 2783:

Parameter "Reg. output AVR" (Channel 2783)

Set point : EIC

Password level : customer

Enable
 High Alarm
 Inverse proportional

Auto acknowledge
Inhibits...
Write OK Cancel

Digital AVR (7565)

Select **DEIF DVC 550** for the digital AVR type on parameter 7565:

Parameter "Digital AVR" (Channel 7565)

Set point : DEIF DVC 550

Password level : customer

Enable
 High Alarm
 Inverse proportional

Auto acknowledge
Inhibits...
Write OK Cancel

Engine I/F (7561)

The engine interface must be configured on parameter 7561:

- If using other external DEIF modules, set this to OFF.
- For other applications set this to anything other than OFF.

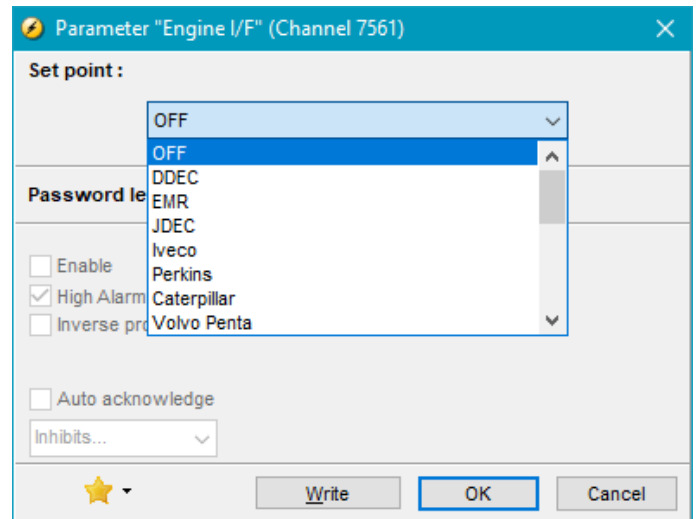

This parameter must be configured even though relay or analogue regulation is used for governor control.

NOTE When performing initial setup of the DVC 550 with the DEIF EasyReg Advanced software, it is recommended not to have the CAN bus connected to the DVC 550.

6.3.6 Voltage transformer settings

The DVC 550 has the possibility to use voltage transformers (VT or PT) for alternator as well as busbar measurements.

The VT ratio is configured in the general settings in the AGC-4 (parameters 6041-6042 and 6051-6052). The DVC 550 provides the opportunity to have different VTs than those used in the AGC-4 (meaning that the range of the DVC 550 VTs is different from the range of the AGC-4 VTs). If this is the case, parameter 7745 must be enabled, and then the parameters 7741 to 7744 are used and must be configured for DVC 550 VT ratio.

NOTE When the communication between the AGC-4 and the DVC 550 is running, multiple settings are sent to the DVC 550. This is, for example, knee set point, soft-start timers, VT settings.



More information

See **Overview of shared parameters** for a list of these settings.

Parameter	Item	Range	Default	Note
7741	DVC 550 VT's primary setting (side that is in contact with generator voltage).	400 V 32000 V	400 V	Only in genset.
7742	DVC 550 VT's secondary setting (side that is in contact with the DVC 550 voltage input).	50 V 600 V	400 V	Only in genset.
7743	DVC 550 busbar VT's primary setting (side that is in contact with busbar voltage).	400 V 32000 V	400 V	Only in genset.
7744	DVC 550 busbar VT's secondary setting (side that is in contact with the DVC 550 voltage input).	50 V 600 V	400 V	Only in genset.
7745	Activation of VT settings in the DVC 550 (when set to ON, the settings above will be sent).	OFF ON	OFF	Only in genset.

6.3.7 Analogue bias connection from AGC-4

It is possible to connect the DVC 550 to the AGC-4 or any other controller, and to have the voltage regulation made using analogue lines.

Control in this way to the DVC 550, means that digital features will not be available. Only voltage regulation will be effective when using the analogue lines.

To use analogue lines, the DVC 550 must be configured for an analogue input.

Configure this under **Regulation mode** and voltage analogue set point.

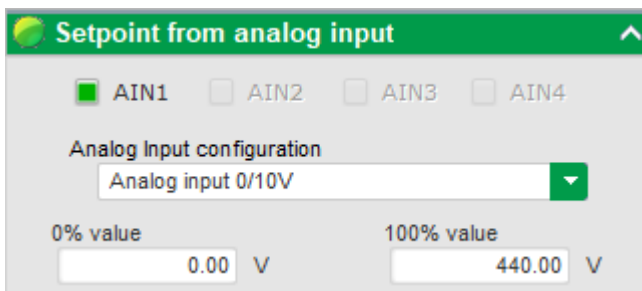

It is also possible to configure analogue regulation from the AGC-4 by switching parameter 2783 to analogue instead of EIC. Remember to set the transducer output also at parameter 5991. At parameter 7796, the input type on the DVC 550 is set, and it will expect it to have an analogue. To enable sending of all these commands, parameter 7805 must be enabled. By this, it is possible to send all commands via CAN bus and to control the DVC 550 via analogue bias using parameter 7796.

6.4 Generator start up

6.4.1 Start modes

The DVC 550 is able to handle two start modes:

- Normal start
- Close before excitation (CBE)

6.4.2 Normal start

Excitation is activated at start-up. Normal start is obtained when close before excitation is disabled at parameter 2254. During a normal start, both the start-on threshold and soft-start function are used.

There two ways to control the excitation ramp for a normal start:

1. With the start-on threshold and soft-start ramp.
2. Where the start-up ramp is controlled by the U/f slope.

1. Control the excitation ramp with the start-on threshold and soft-start ramp.

In this method the excitation ramp is controlled during start-up.

2. Control the excitation ramp with the U/f slope.

In this method the start-up ramp is controlled by the U/f slope.

The DVC 550 will regulate towards this on start-up, as the RPMs are ramping up during a start sequence.

Not using the soft-start functionality is only recommended on engines that slowly ramp up the RPM, since the U/f law ramp-up can give an overshoot.

For this method, configure:

- Start-on threshold to 100 % (7751).
- Upper limit for the start-on threshold to 0 % (7752).
- Soft-start ramp to 0.1 s (7753).

6.4.3 Close before excitation (CBE)

Excitation is applied after the genset is started and the breaker is closed.

Close before excitation is enabled at parameter 2254.

Normally with an analogue AVR, switching on/off the excitation is controlled by a relay output from the AGC to the AVR.

When excitation is switched on, the rate of voltage build-up is controlled solely by the AVR. Using the DVC 550 provides the possibility of switching the excitation on/off without the use of a relay output. The rate of voltage build-up is automatically configured via parameter 2262 as part of the existing setup of close before excitation.



More information

See **AGC-4 Designer's handbook** for more information about the settings for close before excitation.



Example of how the different settings are working

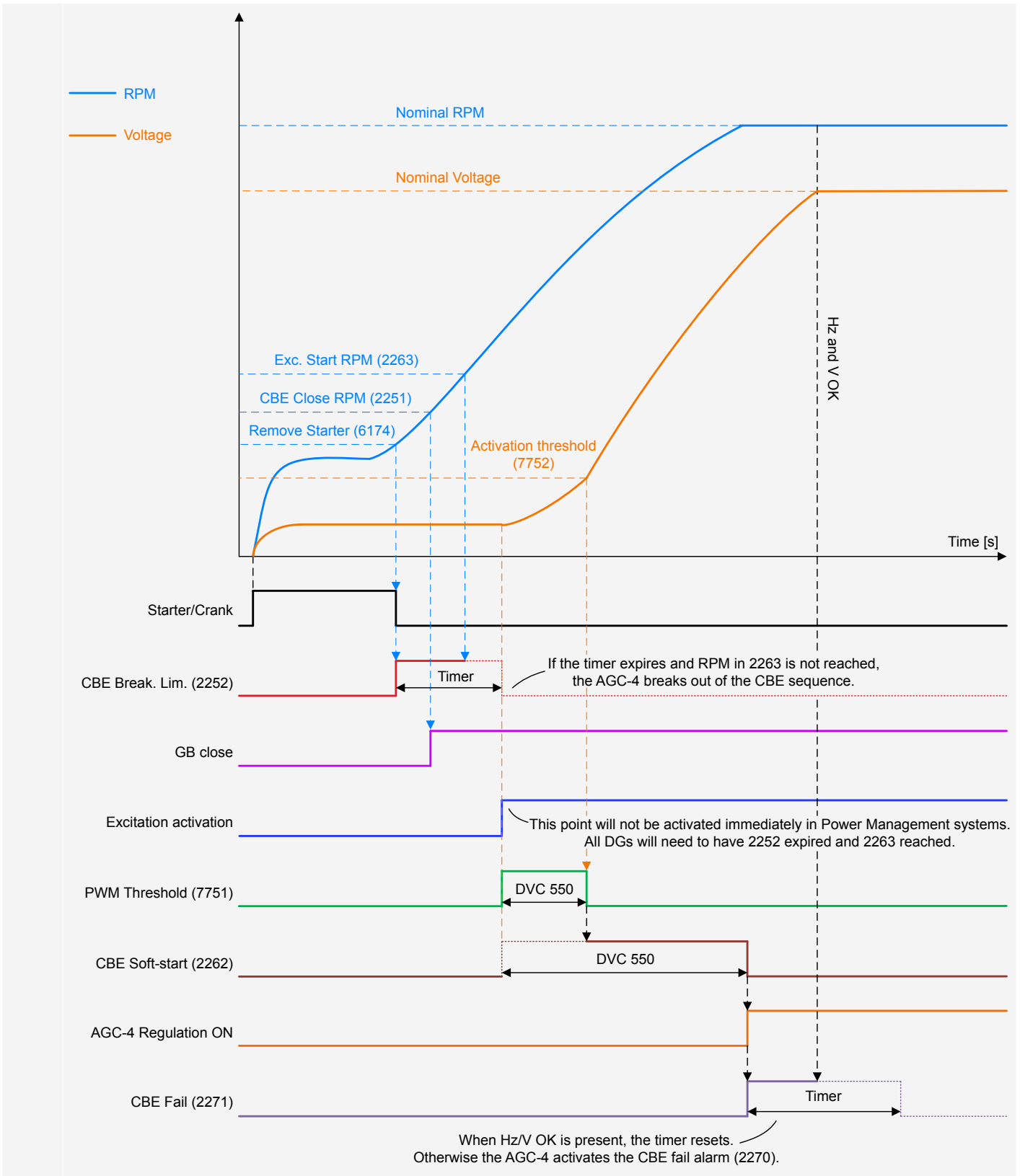

Note that the soft-start ramp time is started when the excitation is started. The soft-start timer should be considered as an angle of slope instead of a specific time.

During a CBE sequence, the start-on threshold function will be used and the soft-start function will also be used. The soft-start timer is not the same for the CBE sequence and a normal start. These are two separate timers/angles which can be adjusted individually.

If the application has been configured to use Close Before Excitation (CBE) during start, the AGC-4 can action additional features to handle the sequence correctly.

If, for example, the application is made for backup power (AMF), it can be chosen what the AGC-4 should do during cooldown. The AGC-4 is able to make a rerun, which means that if a new start request comes during cooldown, the genset(s) can perform the CBE sequence again without stopping the genset(s). To handle the functionality for the rerun and cooldown, some parameters must be configured.

Excitation control during cooldown

Parameter 2266 configures how the AGC-4 should react during cooldown.

It is possible to select between three settings:

- Excitation follow busbar (default)
- Excitation constant OFF
- Excitation constant ON

Excitation follow busbar

If there is voltage on the busbar during cooldown of the specific genset, the excitation is ON. If the voltage on the busbar disappears, the excitation is shut OFF.

Excitation constant OFF

The excitation will be switched OFF, as soon as the GB is open during cooldown. This feature can be handy if the genset fans are pulled mechanically by the genset. Then the genset will be able to make a rerun faster.

Excitation constant ON

The excitation will be ON until the genset stops or a new start request comes. This feature can be handy if the genset fans are driven by the voltage from the genset.

Parameter	Item	Range	Default	Note
2266	Excitation control during cooldown	Excitation follow busbar Excitation constant ON	Excitation follow busbar	Parameter is not shared between gensets.

Voltage rerun level

Parameter 2265, configures how low the voltage must be, before it is allowed to close the breaker during the rerun. If the voltage is not below the **Voltage rerun level** before the **Voltage discharge timer** has expired, the specific genset will be excluded from the CBE rerun sequence.

Parameter	Item	Range	Default	Note
2265	Voltage rerun level	30 % 100 %	30 %	Parameter is not shared between gensets.

Voltage discharge timer

Parameter 2264 configures how long time it takes from the excitation is removed until the voltage is below **Voltage rerun level**. The voltage discharge timer can be started either from a new start request or from when the generator breaker opens. The different reactions are dependent on the selection of **Excitation control during cooldown**.

The two rerun sequences:

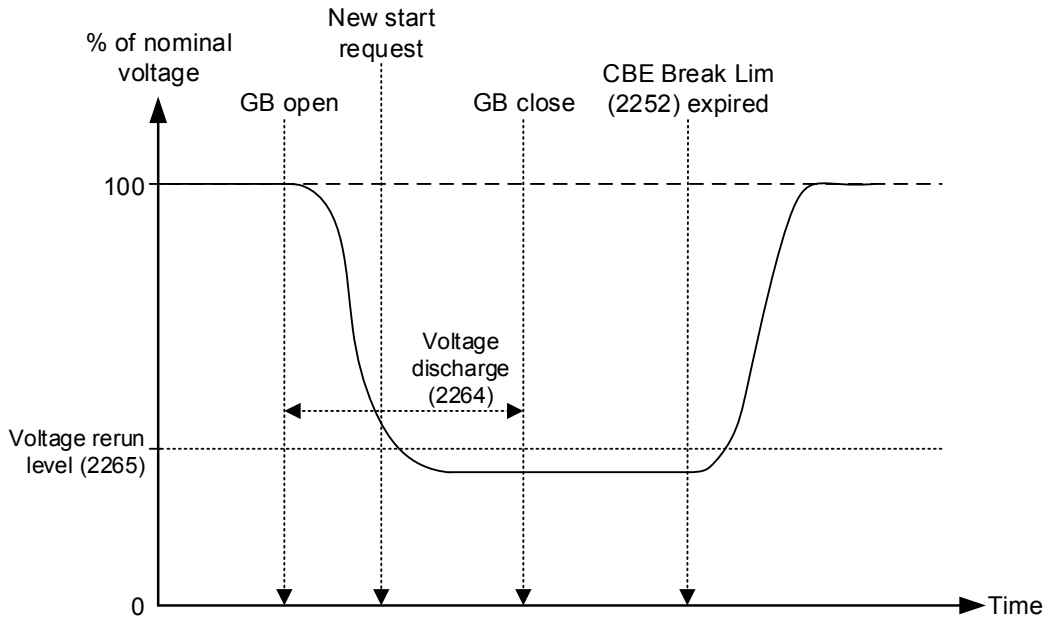

In the diagram above, the excitation is shut off as soon as the breaker is opened. Shortly after the breaker is opened, a new start request appears. The AGC-4 waits closing the GB until the **Voltage discharge timer** has expired.

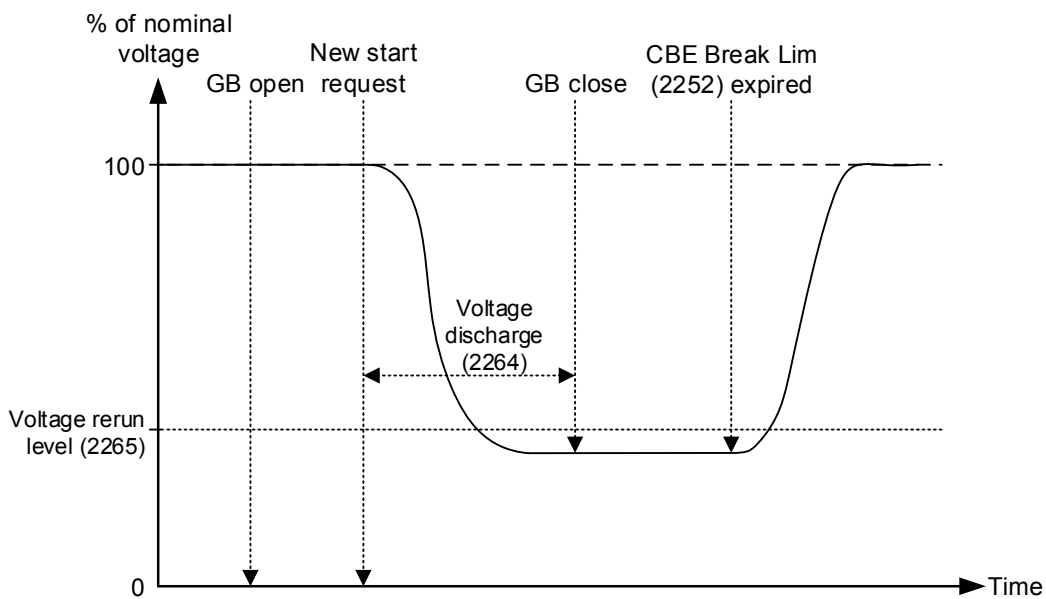

In the diagram above, the excitation is ON during cooldown. Then a new start request is made, which means that the excitation will be shut off. When the excitation is shut off, the voltage discharge timer starts.

Comparing the two situations shows that the first example is the fastest. This is because the excitation is already off when the next start request appears. If the new start request had appeared a little later, the voltage discharge timer could already have expired. This means that the generator breaker could have closed very shortly after the new start request.

Parameter	Item	Range	Default	Note
2264	Voltage discharge timer	1.0 s 20.0 s	5.0 s	Parameter is not shared between gensets.

6.4.4 Excitation ramp

During start-up of a generator, the curve can have different characteristics. During each start, the start-on threshold function and the soft-start function will make a part of the characteristic for the excitation.

If the generator uses Close Before Excitation (CBE), the characteristics will be different from a normal start.

In both a normal start or a CBE start, the start-on threshold and soft-start are used. There are different soft-start timers for normal start and for CBE start.

NOTE The voltage can never exceed the U/f law, which is described later in this document. This also applies during start-up ramps and soft-starts.

6.4.5 Start-on threshold

The first part of the excitation ramp is called the start-on threshold.

The parameters for start-on threshold are located at parameters 7751 and 7752:

Parameter	Item	Range	Default	Note
7751	PWM signal for start-on threshold ramp percentage of nominal voltage	0.00 % 100.00 %	10.00 %	Only in genset
7752	Start-on threshold set point percentage of nominal voltage	0.0 % 100.0 %	35.0 %	Only in genset

Here it is possible to set the upper limit and a PWM output. The upper limit determines when the soft-start function takes over. As a default, this value is set to 35 %, which means 140 V AC for a 400 V alternator. This means that the start-on threshold is the excitation ramp from 0 V AC to default 140 V AC. The PWM output decides how steep the slope for the excitation is. When setting the PWM higher, the excitation slope will be steeper/more aggressive. In the graph below, only the PWM is changed:

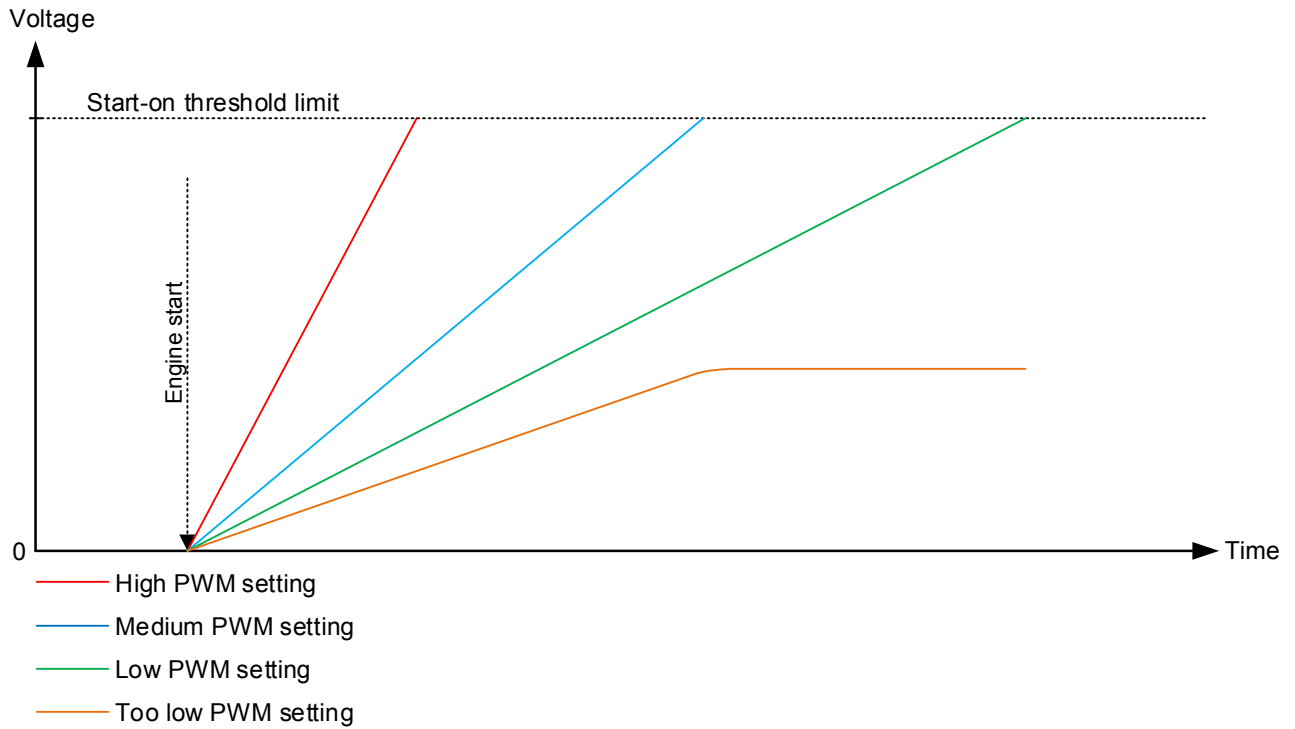

When the upper limit for the start-on threshold is changed, the start point for the soft-start is also changed. The upper limit for start-on threshold is always the start point for soft-start.

6.4.6 Soft-start

When the upper limit of the start-on threshold function has been reached, the soft-start function will be initiated. The soft-start is used from the point of the upper limit of start-on threshold until the nominal voltage has been reached.

In the soft-start function only a timer is available; this the parameter located at 7753:

Parameter	Item	Range	Default	Note
7753	Soft-start ramp timer/ angle	0.1 s 120.0 s	2.0 s	Only in genset

The timer defines how long time it should take for the soft-start to increase the voltage from 0 to nominal voltage.

Example

If the timer is set to 5 seconds, with the start-on threshold set to 120 V AC and the nominal voltage is 400 V AC, the soft-start will be active for 3.5 seconds.

The calculation is:

$$\text{Duration of Soft-start} = \frac{(\text{Nominal voltage}) - (\text{Start-on threshold voltage})}{\text{Nominal voltage}} \times \text{timer for Soft-start}$$

The graph below shows how the different things are placed:

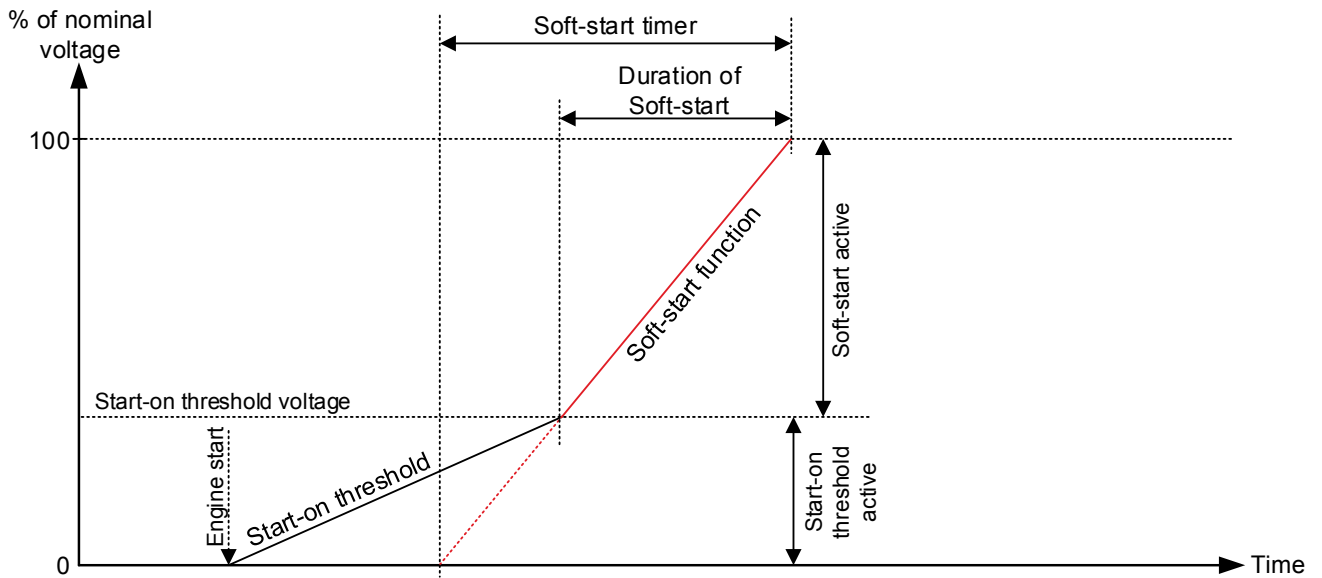

The graph below shows three different settings in the soft-start. The first one has a low timer, the second a medium and the last a high timer. If the DVC 550 has been configured with start-on threshold, the soft-start should not be considered as a timer, but instead as an angle.

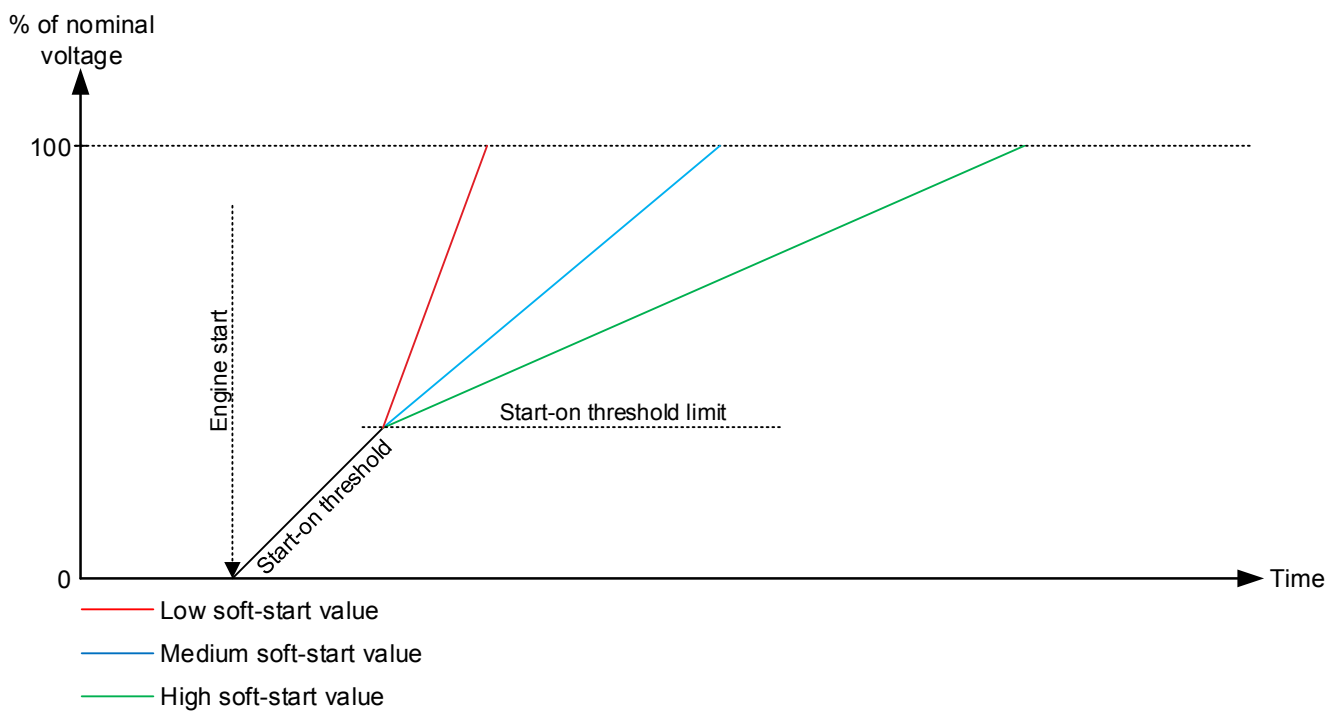

Since the soft-start timer represents how much time it should take to ramp up the voltage from 0 V to nominal, the full timer will not be used if the start-on threshold function is also used.



Example

If the wanted duration of the soft-start is known, the timer to set in the parameter can be calculated:

$$\text{Timer for Soft-start} = \frac{\text{Nominal voltage}}{(\text{Nominal voltage}) - (\text{Start-on threshold voltage})} \times \text{Duration of Soft-start}$$

NOTE If the soft-start ramp is set to 0.1 seconds, the soft-start function is disabled. The DVC 550 will then use the U/f slope when ramping up the excitation.

6.4.7 Excitation during CBE

During a CBE sequence, the excitation ramp will look different from the curves in the normal start. The start-on threshold will be inhibited until the timer in parameter 2252 has run out.

Parameter	Item	Range	Default	Note
2252	Timer for initiation of the start-on threshold	0.1 s 999.0 s	5.0 s	Only in genset
2262	Soft-start timer during CBE sequence	0.0 s 999.0 s	5.0 s	Only in genset

The timer at parameter 2252 decides how long it should take before the excitation from the DVC 550 begins. The generator is able to build up some voltage because of the remanence in the rotor of the alternator.

The CBE excitation curve will have a characteristic as shown below:

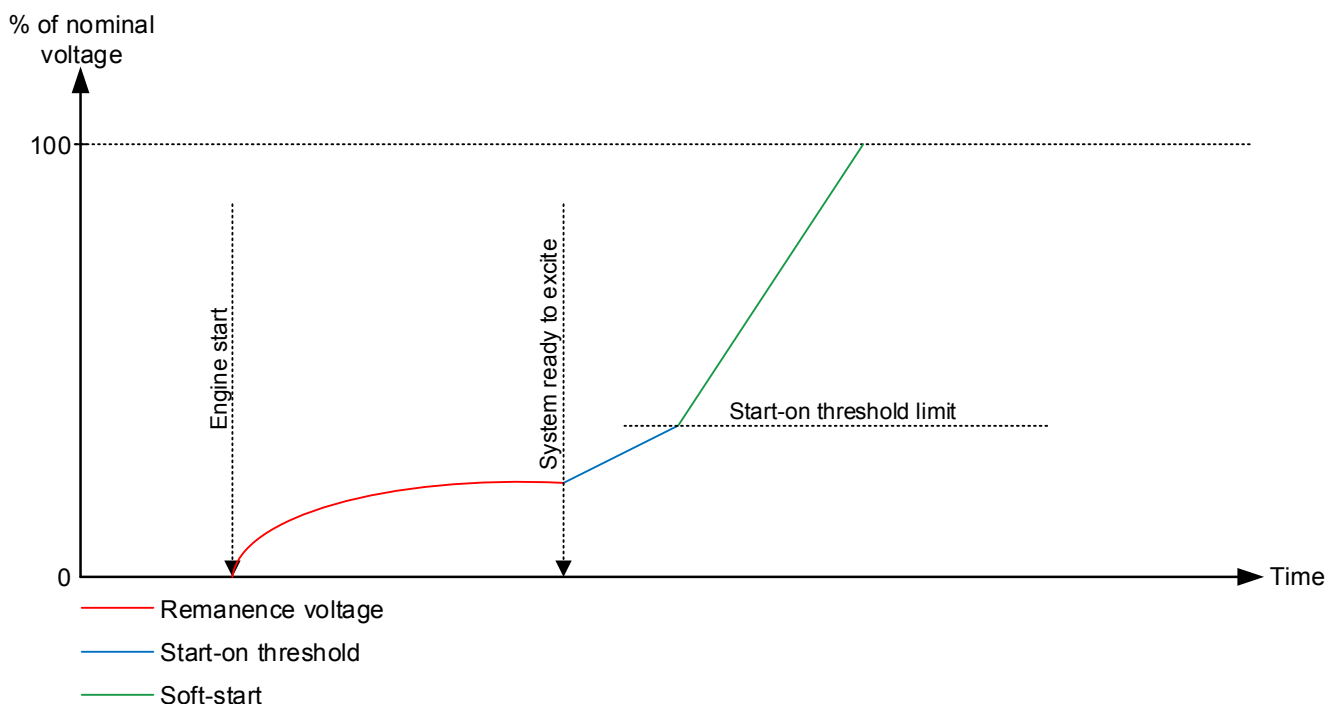

The soft-start timer in CBE is not the same as the soft-start timer in normal start, but the start-on threshold parameters are the same as in the normal start. Having different settings for the soft-start gives the possibility to have, for example, a more aggressive excitation ramp for CBE sequences. The timer for the soft-start in CBE is located in parameter 2262. Note that this timer is different from the one in normal start.

6.5 Magnetisation or inductive motor starting

6.5.1 Stator current limitation

DVC 550 provides the possibility of limiting the stator current. This can be used when applying inductive loads drawing large in-rush currents such as transformers and inductive motors. The function can be controlled through the AGC-4.

During normal operation, the DVC 550 will have the voltage as set point. When stator current limitation is active, the DVC 550 will instead keep the current as reference and let the voltage drop until the voltage reaches nominal level again.

Activate current limitation in the AGC-4 at parameter 7795:

- Off
- Magnetisation
- Inductive motor

The selection of stator current limitation type is also available through M-Logic. The M-Logic commands related to the DVC 550 can be found later in this manual.

6.5.2 Magnetisation

Use the magnetisation function when a load must be magnetised up to nominal voltage. When the function is enabled, the current will only rise to a point defined in parameter 7793.

The AGC-4 raises the voltage until nominal voltage has been reached and then closes the generator breaker. Before the breaker is closed, the AGC-4 activates the stator current limitation function in the DVC 550. When the current decreases, the stator current limitation function disables again.

The DVC 550 regulates with the current as the set point. This parameter indicates a percentage of the nominal current for the genset. The DVC 550 lets the voltage drop and keeps the current at a constant level. The voltage will then start to rise, and when it reaches its nominal voltage, the DVC 550 will instead regulate with the voltage as set point again. The current will then decrease again. When the current has decreased to a level of 5 % below the current limitation, the transformer magnetisation function is not active any more. The transformer magnetisation will not be activated again until the generator breaker has been opened. If the genset is closing the breaker towards a busbar with live voltage, the transformer magnetisation function will be deactivated as soon as the breaker is closed, because then the transformer will already be magnetised.



Example with the transformer magnetisation function:

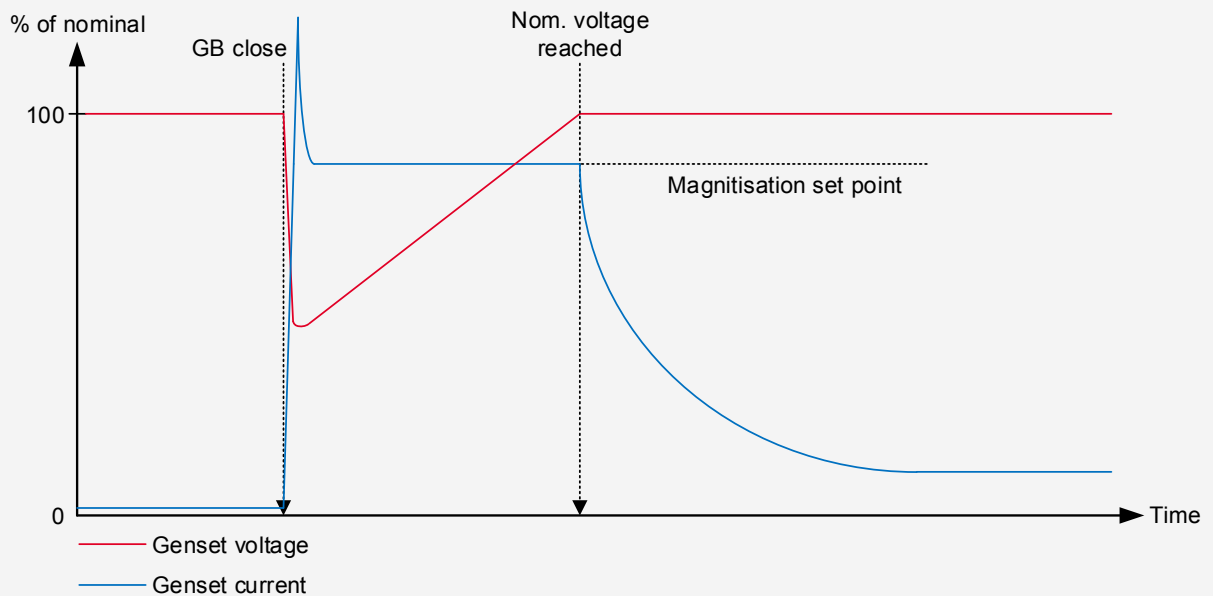

The first dotted line shows when the generator breaker (GB) closes.

The second dotted line shows when the transformer magnetisation function will be deactivated (5 % below the current limitation set point configured at parameter 7793).

Parameter	Item	Range	Default	Note
7793	Current limitation for magnetisation	0.0 % 300.0 %	100.0 %	Only in genset
7795	Enabling of current limitation function	OFF Inductive motor	OFF	Only in genset

NOTE Settings at parameters 7793 and 7795 are treated as shared set points among the AGC DG units in power management applications.

6.5.3 Inductive motor starting

NOTE The inductive motor function is not active when the generator is parallel to the mains.

The inductive motor function is very similar to the magnetisation function.

The main difference is that the magnetisation function is only active when the generator breaker has just been closed, whereas the inductive motor starting function is active all the time the genset is running and the generator breaker is closed, and the function is enabled.

If a heavy inductive load is turned on, the current from the generator will rise, which gives a risk of tripping an over-current protection. To avoid tripping the over-current protection, the DVC 550 is capable of limiting the current by dropping the voltage instead. By lowering the voltage, the power produced from the genset is also reduced, which means a lower risk of tripping from an over-power protection.

If the inductive motor function is active all the time, the genset will drop the reactive power, and the short circuit level will not be maintained during a short circuit. The inductive motor function can be enabled/disabled with M-Logic, so that it can be controlled by either a digital input or with some custom-made logic.



Example with the inductive motor function:

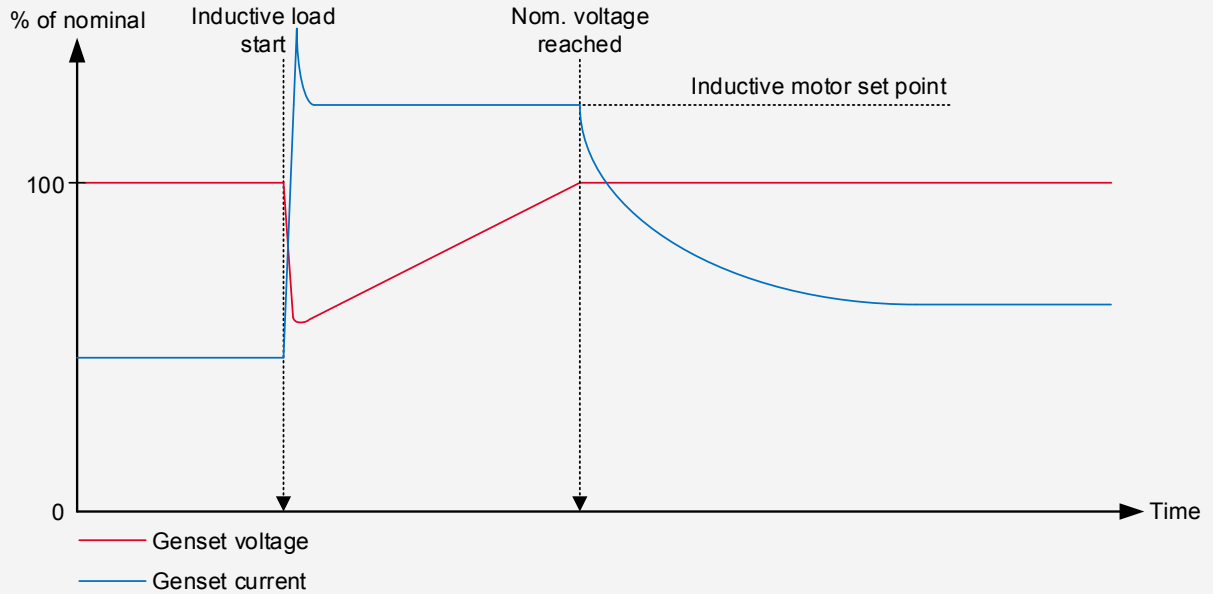

When the inductive load is turned on, the current will rise. The inductive motor function will limit the current to the pre-defined level set in parameter 7794. The DVC 550 will change to have the current as set point and let the voltage drop. When the voltage reaches the nominal value again, the DVC 550 will change to regulate with the voltage as set point again.

Parameter	Item	Range	Default	Note
7794	Current limitation for inductive motor	0.0 % 300.0 %	100.0 %	Only in genset
7795	Enabling of current limitation function	OFF ON	OFF	Only in genset

NOTE Settings at parameters 7794 and 7795 are treated as common set points among the AGC DG units in power management applications.

6.6 Operation modes

6.6.1 U/f variable slope (knee function)

NOTE This function is automatically disabled by the AGC-4 when operating parallel to mains.

The U/f variable slope (U/f law) determines the voltage reference/set point used by the DVC 550, depending on the frequency.

The U/f law is used to ensure that the genset does not reach its cutout limit. Some gensets are restricted to cut out when reaching 40 Hz, for example. This limit can be reached at heavy loads. If the dip in frequency is below the genset's cutout limit, the genset will be forced to stop. The U/f law allows the voltage to droop and by this reduce the torque on the engine, so the frequency can be kept above the cutout limit. This function will not work with load that determines constant power, such as frequency converters and UPS installations. But it will work with, for example, electrical motors and electrical heaters where the voltage can be reduced.

The U/f law determines how much the DVC 550 should droop the voltage compared to the frequency drop at big loads. It is possible to configure at which frequency the knee set point should be, and this is set in parameter 7771. Below the knee set point, the DVC 550 will let the voltage droop. The slope of how much the voltage should droop compared to the frequency can be set in parameter 7772.

The changes on the U/f law are shown in the graph below. The knee point is held constant in all of them. The graph shows how much the DVC 550 will regulate down in nominal voltage:

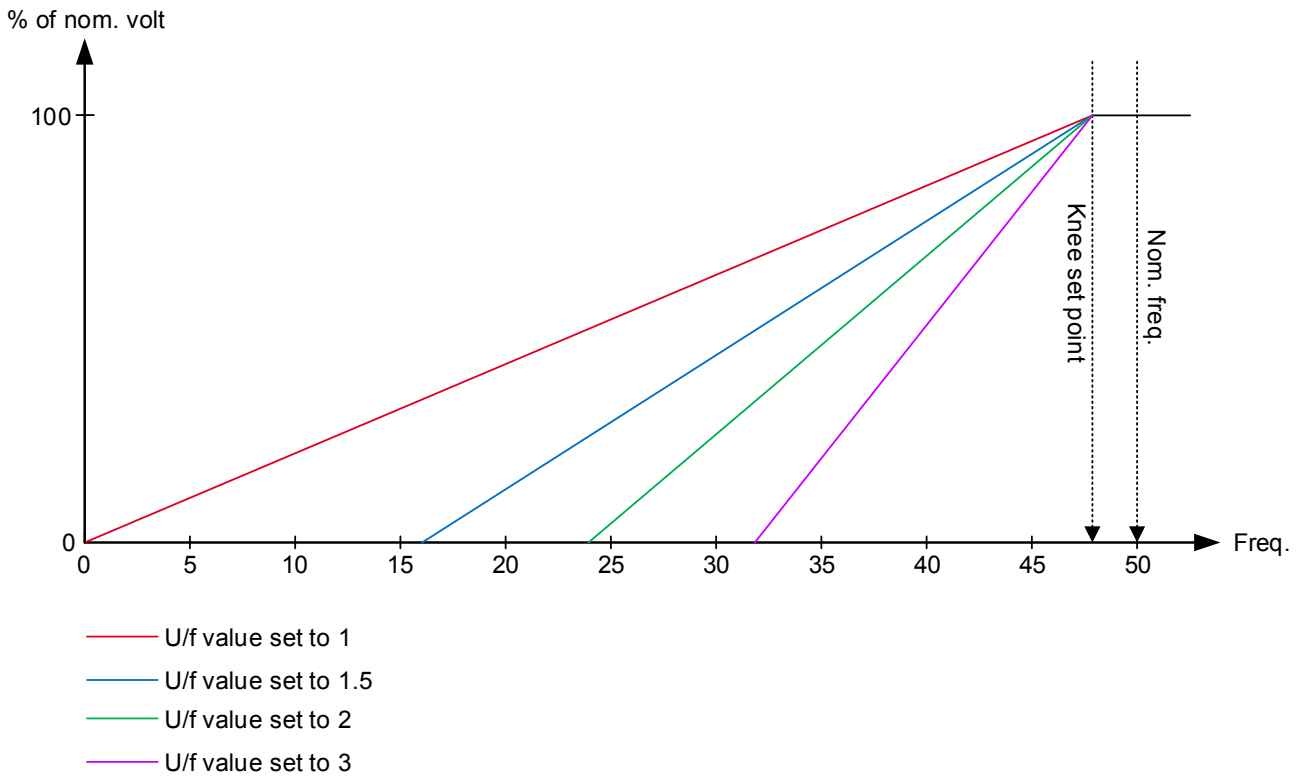

The knee set point determines when the U/f law becomes active. When the frequency goes below the knee set point, the U/f law defines a temporary voltage set point for the DVC 550.

The U/f setting can also be calculated:

$$U/f = \frac{100 - \left(\frac{\text{Minimal voltage}}{\text{Nominal voltage}} \times 100 \right)}{\text{Knee set point} - \text{Cutout limit}}$$



Example

A genset has the nominal voltage of 400 V AC, the knee set point is set to 48 Hz.

The genset will cut out at 40 Hz, and the breaker will open at 350 V AC.

$$U/f = \frac{100 - \left(\frac{350}{400} \times 100 \right)}{48 - 40} = 1.56$$

So the U/f slope can now be set to either 1.5 or 1.6.

The U/f law (knee function) is set up in the parameters shown below:

Parameter	Item	Range	Default	Note
7771	Knee set point	70.0 %	96.0 %	Only in genset

Parameter	Item	Range	Default	Note
		100.0 %		
7772	U/f variable slope	0.5 5.0	1.0	Only in genset

The voltage regulator of the AGC-4 is inhibited in case the frequency drops below knee set point.

Voltage reference is limited by U/f law at any time.

6.6.2 Load acceptance module (LAM)

NOTE This function is automatically disabled by the AGC-4 when operating parallel to mains.

The DVC 550 supports LAM, which is a functionality to optimise transient performance of frequency when high load steps are applied.

The LAM function is only used together with the Soft voltage recovery (SVR), see parameter 7774.

This is achieved by dropping the voltage reference momentarily when the frequency drops below the knee point. In this way, the torque demand on the engine is reduced momentarily. Afterwards, the voltage is raised slowly (according to the soft voltage recovery setting) towards the voltage reference defined by the U/f law. The LAM function can be used to gain more stability in the regulation when a big load impact has been experienced. The percentage set in the LAM function defines how many percent the voltage is allowed to drop, as soon as the knee point is reached.

A comparison of U/f and LAM system performance is shown below:

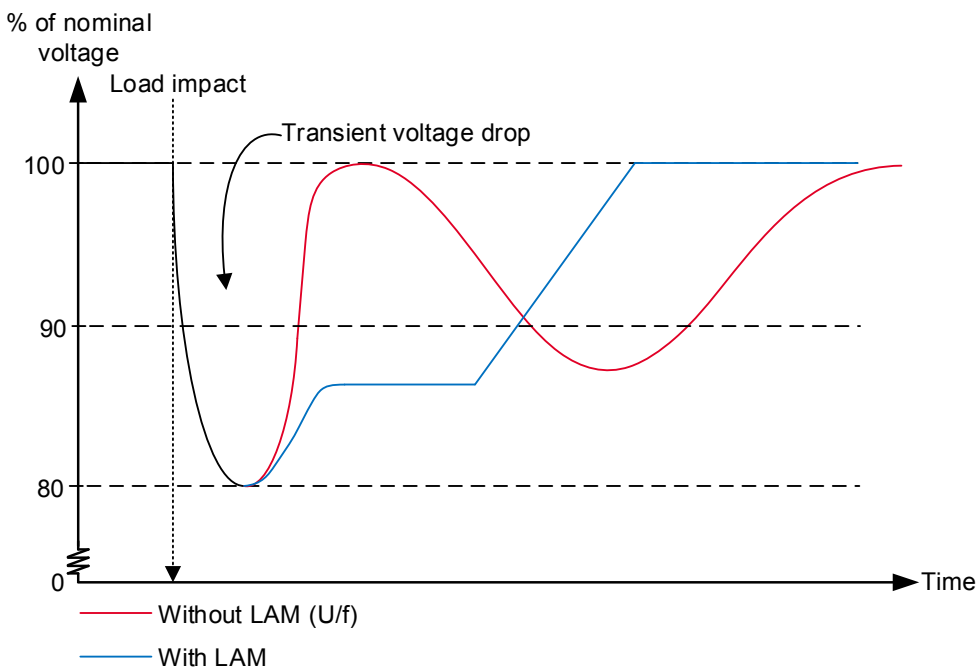

In the graph above, a comparison is made with and without the LAM function. Without the LAM function, the voltage may get unstable at load impacts. Here it is only the U/f law from the knee set point function that determines the voltage set point. With the LAM function, it is allowed to drop the voltage for a short time. The LAM function will start to ramp up the voltage when the frequency is starting to ramp up again. The slope of the ramp-up of the voltage is controlled by the soft voltage recovery function, which will be described later.

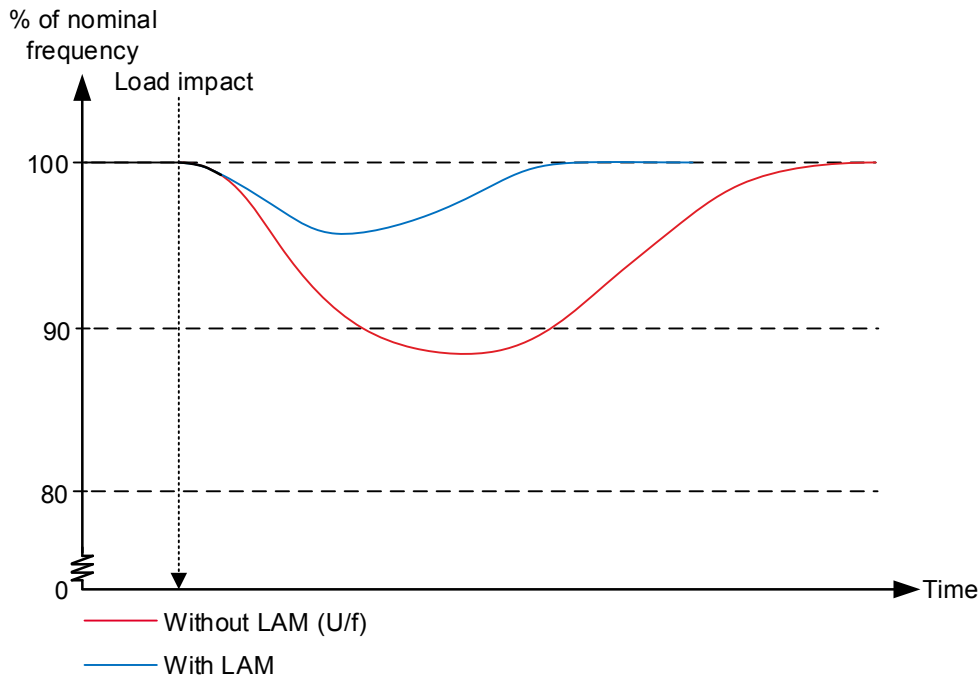

The graph above shows that with the LAM function, the frequency will rise and stabilise faster after a big load impact. This is because the LAM function will drop the voltage and by this lower the torque on the engine.

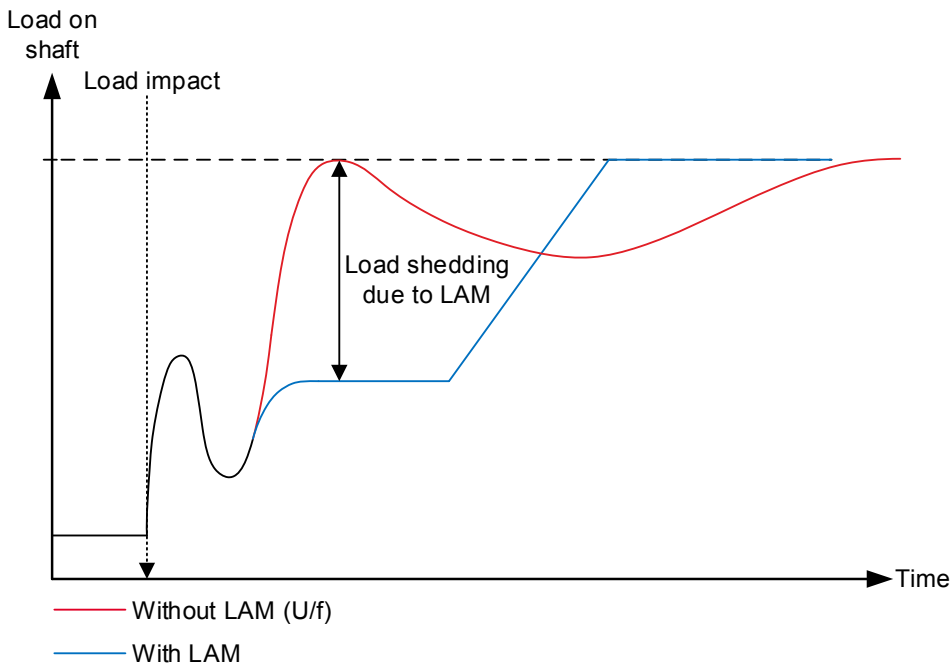

The graph above shows a comparison of the load on the shaft of the engine, with the LAM function enabled and disabled. When the LAM function drops the voltage, the torque on the shaft is lightened, which makes it possible for the engine to rise faster in RPM after a load impact. This also gives the possibility to steadily reach nominal values faster after the load impact, since the LAM function will increase system stability.

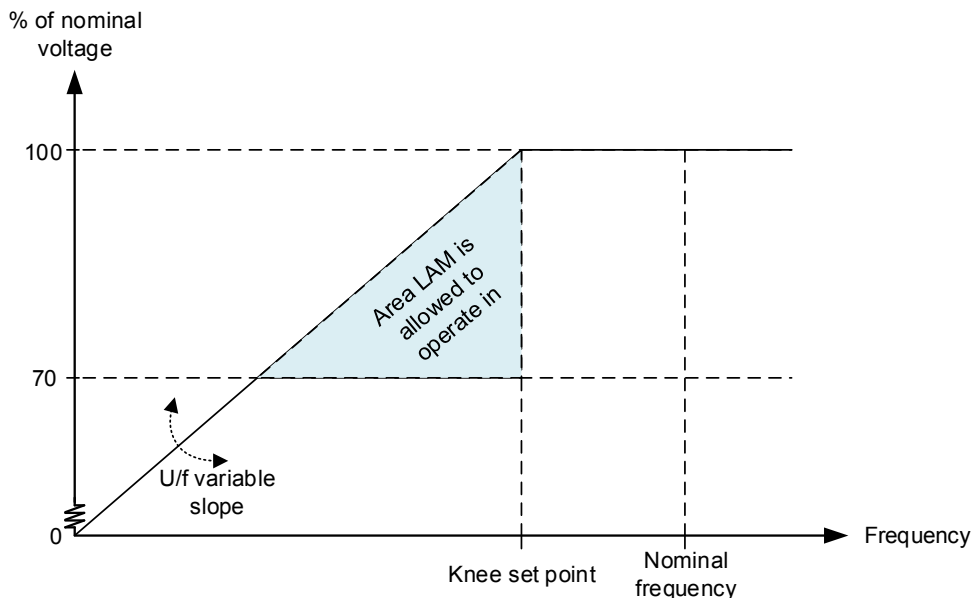

The graph above is very similar to the U/f law graph. The difference is that a triangle is marked here. When the LAM function is enabled, the genset is allowed to be inside the marked area. When having the U/f law, the DVC 550 will never cross the U/f law line in the graph, but will always seek to be near it. When the genset is above the knee set point, the DVC 550 will regulate up to the nominal voltage instead. But as long as it is in the marked area (triangle), the DVC 550 will have the U/f law to determine the voltage set point.

The LAM set point in the DVC 550 is set in percentage of how much it should drop the voltage compared to nominal. So if a set point of 10 % is made, the voltage will drop to 90 % of nominal when the LAM function is active. In the AGC-4, the LAM function is set on how much it should drop to when LAM is active. So, if the LAM function in the AGC-4 is set to 90 %, the DVC 550 will drop the voltage to 90 % of the nominal voltage when LAM is active.

Parameter	Item	Range	Default	Note
7774	Activation of LAM function	OFF SVR + LAM	OFF	Only in genset. Set to SVR + LAM to enable.
7775	LAM set point	70 % 100 %	90 %	Only in genset. Defines the voltage level to which the voltage is dropped when the knee set point is reached.
7776	LAM duration	0.0 ms 10000.0 ms	1000.0 ms	Only in genset.

NOTE Settings at parameters 7774, 7775 and 7776 are treated as shared set points among the AGC DG units in power management applications.

6.6.3 Soft voltage recovery (SVR)

NOTE This function is automatically disabled by the AGC-4 when operating parallel to mains.

Soft voltage recovery (SVR) helps the genset return to its rated speed after experiencing a voltage drop due to a load impact. This is done by gradually increasing the voltage towards the voltage defined by the U/f law. The SVR is activated when the frequency drops below the knee point and an increase in frequency is detected. The setting for the SVR function defines the slope for the voltage recovery after a load impact. The SVR setting in parameter 7773 defines how many seconds the voltage should take to recover to nominal voltage from a percentage drop of voltage due to load impact.



Example

Different SVR settings are shown at 5 % voltage drop due to a load impact:

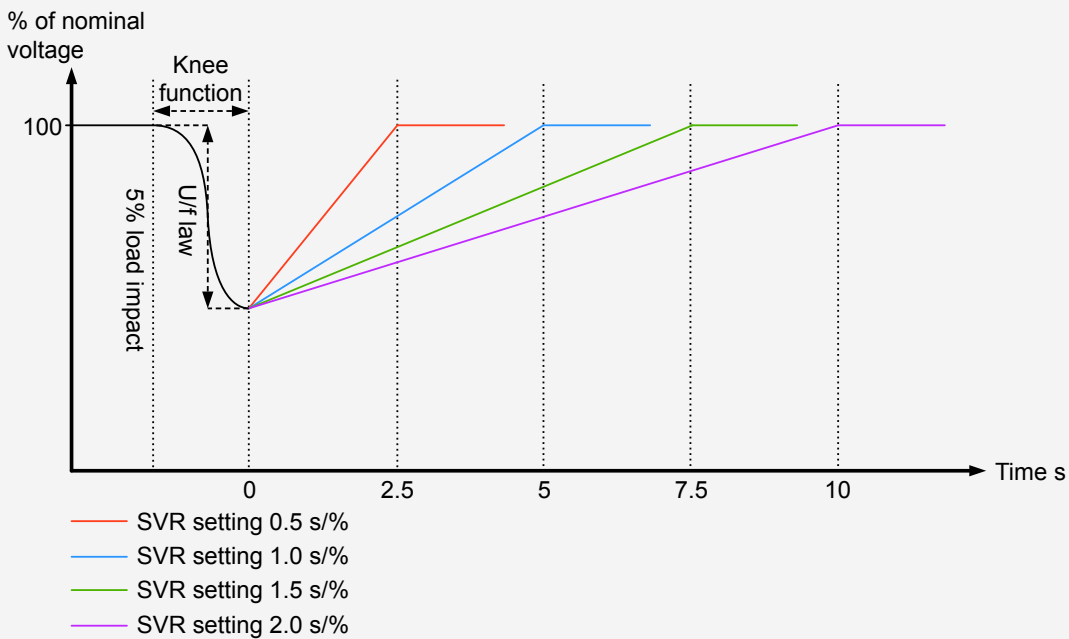

The dotted line at time point 0 represents where the frequency is starting to recover again. When the frequency starts to recover, the SVR function will be activated. When the genset is exposed to a 5 % voltage drop due to a load impact and the SVR setting is 1.0 s/%, the voltage will be recovered in 5 seconds. But the U/f law can still not be passed, which can make the SVR longer than for example 5 seconds. This can happen if the engine is not fast to recover in RPM from a load impact.

The voltage regulator of the AGC-4 is inhibited in case the SVR functionality is active. Regulation is activated again when the SVR timer runs out.

Parameter	Item	Range	Default	Note
7773	Soft voltage recovery timer	0.0 s/% 10.0 s/%	0.2 s/%	Only in genset
7774	Activation of soft voltage recovery function	OFF SVR + LAM	OFF	Only in genset

NOTE Parameter 7774 is treated as a shared set point among the AGC DG units in power management applications.

6.6.4 Droop compensation

NOTE This function is automatically disabled by the AGC-4 when operating parallel to mains.

Two types of droop compensation are supported by the DVC 550:

- Reactive droop.
- Voltage line droop.

They can be controlled with the AGC-4.

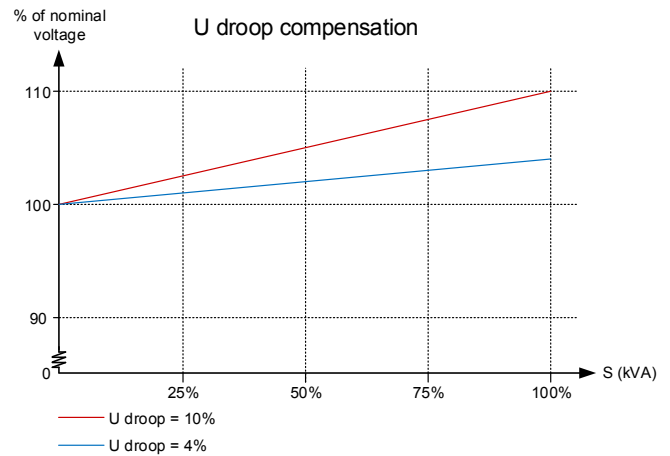
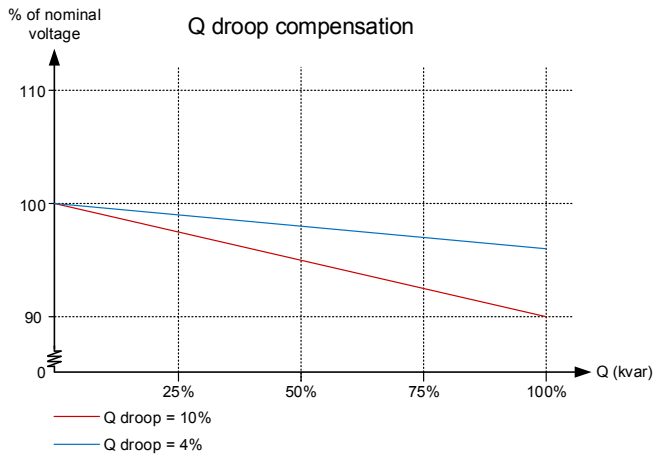

The droop compensation decides how much the voltage is allowed to droop if the regulation is turned off in the AGC-4. The regulation can be turned off by setting the AGC-4 to MANUAL. The regulation can also be off if the CAN bus cables should break. With the droop, it is possible to give the DVC 550 a set point for the voltage if an error in the CAN bus lines should occur. This makes it possible for the genset to share the reactive load when no interfacing is available.

It is recommended that the U droop compensation is not turned on when interfacing the DVC 550 with a AGC-4. These functions will try to work in opposite directions, which may cause instability.

All settings for droop are found in menu 7780 - Droop compensation.

Parameter	Item	Range	Default	Note
7781	Q droop compensation set point	0.0 % 10.0 %	2.0 %	Only in genset
7782	U droop compensation set point	0.0 % 10.0 %	2.0 %	Only in genset
7783	Activate droop compensation type	Q droop compensation OFF	Q droop compensation	Only in genset

NOTE All settings at menu 7780 are treated as common set points among the AGC DG units in power management applications.

NOTE Only one of the droop functions can be active.

6.7 Genset modes

6.7.1 Genset modes

The AGC-4 with the DVC 550 give two new genset modes.

These are available at parameter 6070 - Genset mode:

- Dry alternator
- Ventilation

6.7.2 Genset mode : Dry alternator

The purpose of the dry alternator mode is to dry the windings in the generator before use. If the genset has been standing outside there could be moisture on the windings. The reason for drying the windings is to prevent the winding insulation from being degraded due to moisture in the generator and to prevent arc-over in the windings. External heat sources can be used to vaporise the moisture, but the DVC 550 provides the possibility of using the alternator to dry the windings instead.

We need to create a short circuit of the busbar, so when the GB closes, the generator will supply an intentional short circuit:

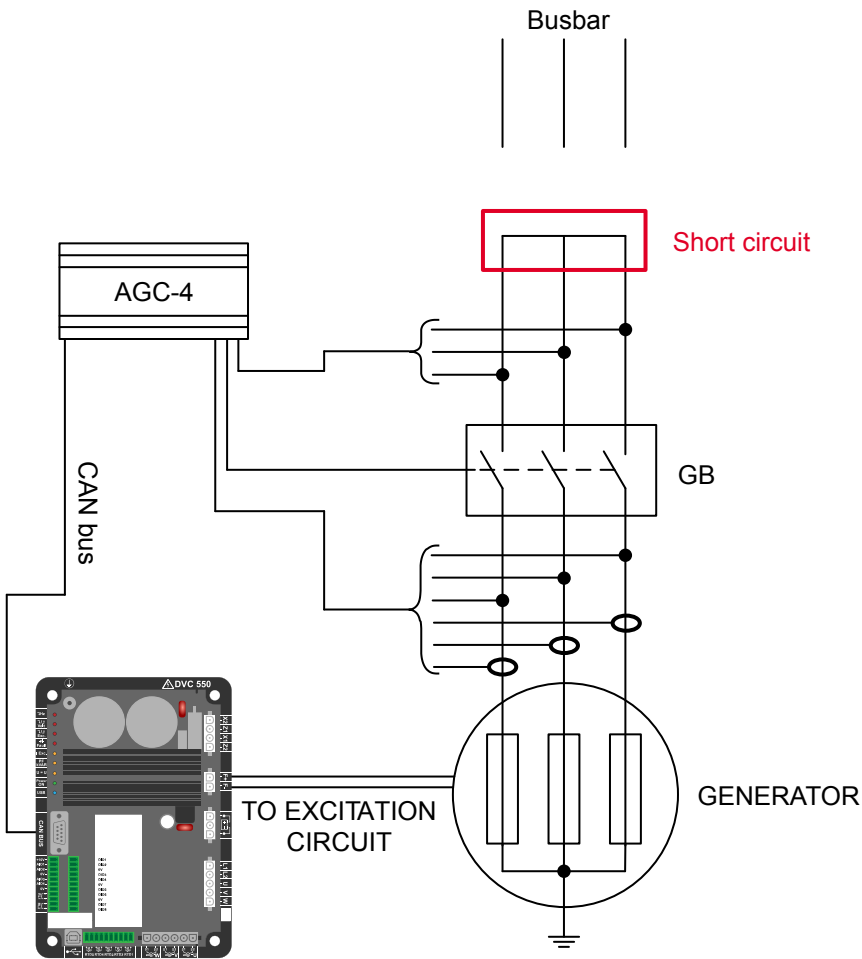

1. Configure parameter 7791 to a set point of 0.1 A.
 - If the set point is set to 0.1 A, the DVC 550 will supply 0.1 A excitation current.
 - This will result in much higher current in the stator, and the heating from the stator current will dry the windings.
2. Configure parameter 6070 (Genset mode) to **Dry alternator**.
3. Start the genset in semi-auto mode and close the GB.
4. When the windings are dried out, open the GB and stop the genset.
5. Configure parameter 6070 (Genset mode) back to your original genset mode.
6. Start the generator again and close the GB.
7. The DVC 550 will slowly raise the excitation current.
8. If the voltage is not raised, the AGC-4 will make a shutdown, because it means that the short circuit is not removed.

Parameter	Item	Range	Default	Note
7791	Excitation reference for dry alternator	0.0 A 20.0 A	1.5 A	Only in genset

NOTICE

Excitation supply

If the excitation supply for the DVC 550 comes from AREP or shunt, an external supply is needed when running dry alternator mode. Only a PMG does not require external supply.

6.7.3 Genset mode : Ventilation

The purpose of ventilation is to remove humidity before use.

1. Configure parameter 6070 (Genset mode) to **Ventilation**.
2. Start the genset in semi-auto mode with open GB.
 - The generator will be ventilated by fan air.
 - The excitation current will be 0 A.
3. Configure parameter 6070 (Genset mode) back to your original genset mode.

6.8 Protections

6.8.1 Introduction

The DVC 550 provides many configurable protection functions. These must be configured with the DEIF EasyReg Advanced software.



More information

See **Protections** in the chapter **About the DVC 550** for more information about all of the available protections.

The AGC-4 can be configured to display and log alarms created from the DVC 550.

The alarms logged can then be viewed:

- On an AGC-4 display by using the jump menu 9090.
- In the event log for the AGC-4.

6.8.2 Alarm logging from DVC 550 to AGC-4

Two additional parameters need to be enabled, that will activate when alarms are created by the DVC 550.

Parameter	Description
7761 DAVR Warning	Activates if a protection is activated by the DVC 550 where <i>Action after fault</i> : <ul style="list-style-type: none"> • 0 : No action
7763 DAVR Trip	Activates if a protection is activated by the DVC 550 where <i>Action after fault</i> is either: <ul style="list-style-type: none"> • 1 : Stop regulation • 2 : Shutdown current • 3 : Field current before fault

The log entry for either parameter includes a fault value, which provides information on which fault was created.

Example AGC-4 event log

Text	Timestamp	Active	Ack status	Ack action
GB Pos. fail	2019-10-24 13:35:58,189	Active	Not ack.	Acknowledge
Emergency STOP	2019-10-24 13:35:58,189	Active	Not ack.	Acknowledge

In this example, the **DAVR Trip** and **DAVR Warning** have these values:

108	Tacho	Alarm value
0	0	38
0	0	39

- DAVR Trip - value 38
- DAVR Warning - value 39

DAVR Trip shows that **AIN1 Wirebreak fault** was detected.

DAVR Warning shows that **AIN2 Wirebreak fault** was detected.

Table 6.2 List of AGC-4 alarm values from DVC 550

Alarm value	Description
1	Over-voltage
2	Under-voltage
3	Over-frequency
4	Under-frequency
5	Open diode
6	Shorted diode
7	Reverse active power
8	Reverse reactive power
9	Pt100 1 alarm
10	Pt100 1 fault
11	Pt100 2 alarm
12	Pt100 2 fault
13	Pt100 3 alarm
14	Pt100 3 fault
15	Pt100 4 alarm
16	Pt100 4 fault
17	Pt100 5 alarm
18	Pt100 5 fault
19	PTC 1 fault
20	PTC 2 fault
21	PTC 3 fault
22	PTC 4 fault
23	PTC 5 fault
24	Loss of AC voltage sensing
25	Unbalanced voltage
26	Unbalanced current
27	Short circuit
28	Excitation chain fault
29	Motor start
30	Power bridge overload

Alarm value	Description
31	Battery supply low
32	CAN supply low
33	Pt100 1 open/short
34	Pt100 2 open/short
35	Pt100 3 open/short
36	Pt100 4 open/short
37	Pt100 5 open/short
38	AIN1 wirebreak fault
39	AIN2 wirebreak fault
40	AIN3 wirebreak fault
41	AIN4 wirebreak fault
42	AOUT1 overload/wirebreak
43	AOUT2 overload/wirebreak
44	AOUT3 overload/wirebreak
45	AOUT4 overload/wirebreak
46	DOUT overload fault

6.9 DVC 550 options

6.9.1 IN, IN/2, IN/3 or IN/4 sensing

On some alternators, the current transformers (CT) can be mounted inside the alternators. The DVC 550 needs to be configured for this type of CT.

The DVC 550 can be set to IN, IN/2, IN/3 or IN/4 sensing from the wiring configuration page for the CT. Use the calculator option



on the CT configuration:

CT
CT connection
2: GEN_V

Generator CT

Primary (A)	Secondary (A)	Phase shift (°)
<input type="text" value="100.0"/>	<input type="text" value="1.0"/>	<input type="text" value="0.0"/>

Main CT

A new window displays the configuration options:

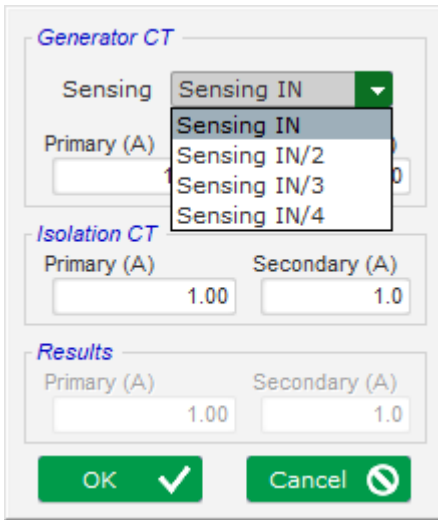

Under **Sensing**, then select:

- **Sensing IN**
 - This is the default setting.
 - When IN is selected, it means that the CT measures the full current.
- **Sensing IN/2**
 - When IN/2 is selected, it means that the CT measures half of the full current.
- **Sensing IN/3**
 - When IN/3 is selected, it means that the CT measures one third of the full current.
- **Sensing IN/4**
 - When IN/4 is selected, it means that the CT measures one fourth of the full current.

6.9.2 Negative forcing

The negative forcing function enables the DVC 550 to reverse the excitation voltage because of the principle with two transistors instead of one.

It allows to have reversed voltage at the output (field excitation), because the two transistors are in parallel and upside down. This function can be useful if the DVC 550 is placed in an application where big loads are turning off. When shutting off a big load, the voltage may increase.

By reversing the excitation for a moment, the nominal voltage will be recovered faster.

In the graph below, it is shown with the negative forcing function enabled and disabled.

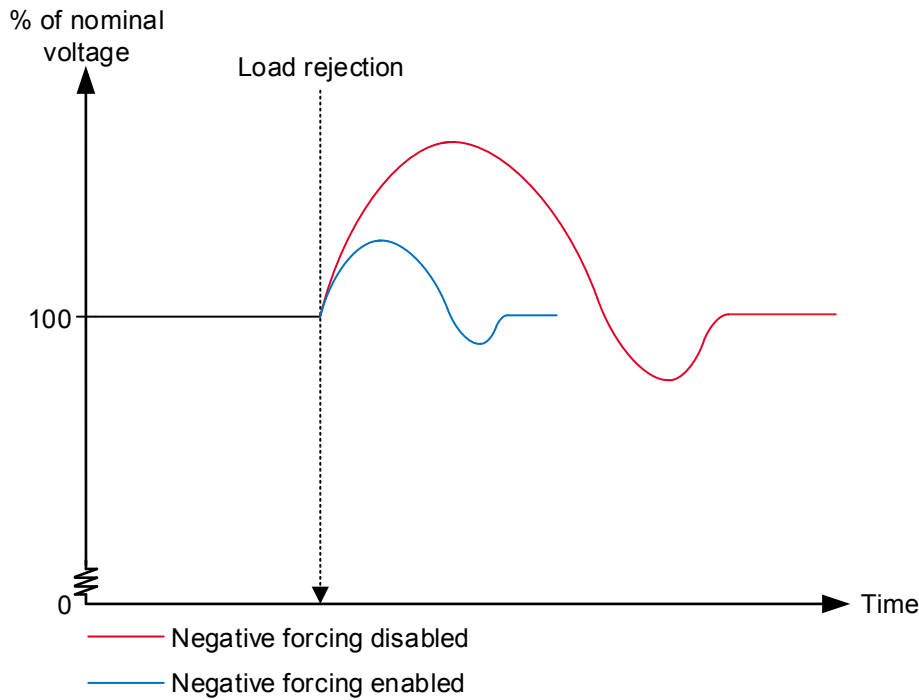

More information

See **PID settings** in the **Configure the DVC 550** for more information about Negative forcing.

6.9.3 VBus compensation

This function is used to compensate for the deviations in voltage, to which the excitation circuit can be exposed.

If the excitation circuit's supply voltage is lower for a moment, the excitation current will also be lower at this time. The PID controller must then be slightly more aggressive to raise the excitation current again.

Alternatively, if the excitation circuit's supply voltage is higher than normal, the PID controller must be less aggressive to make sure that the excitation will match the nominal voltage.



More information

See **PID settings** in the **Configure the DVC 550** for more information about DC Bus voltage compensation (VBus).

6.10 Regulation of DVC 550

6.10.1 PID settings

Configure the PID settings for the AGC-4 under menu 7800.

Parameter	Description	Comment
7801	PID Gain	This is a gain for the PID regulator in the DVC 550
7803	Wr All settings	This parameter sends all settings to the DVC 550. <ul style="list-style-type: none"> This is a pulse command. By default the parameter returns to OFF state after use.

The PID regulators can only be changed with DEIF EasyReg Advanced software.



More information

See **PID settings** in the **Configure the DVC 550** for more information about PID configuration.

When the AGC-4 has the control (parameter 7805 is enabled) only the voltage regulators are used. The gain for voltage regulator is set from the AGC-4 at parameter 7801.



More information

See **DAVR control** in **Bias and control** for more information about the AGC-4 control settings.

With parameter 7803, the AGC-4 writes the settings as the settings are made. The user can apply this parameter to ensure that all the settings regarding the DVC 550 in the AGC-4 are written once more.

The ranges and defaults for the parameters are shown below:

Parameter	Item	Range	Default	Note
7801	PID gain in DVC 550	1 100	20	Only in genset
7803	Write all settings to DVC 550	OFF ON	OFF	Only in genset. When set to ON, it will automatically reset to OFF.

6.10.2 Bias and control

Bias range

Parameter 7804, the AGC-4 can control how wide the bias range should allow the AGC-4 to control the voltage in the DVC 550.

By default, it is set to +/- 10 %, which means that the AGC-4 is allowed to regulate the voltage on a 400 V genset from 360 V to 440 V. The bias range should be wide enough to ensure that the gensets can load-share the reactive power in both capacitive and inductive situations. By making the bias range wider, the resolution for load sharing between the AGC-4s will be harder, since a small step gives a bigger response. By experience, the +/- 10 % bias range covers most applications.

The bias range is for CAN bus based bias signal or for analogue bias and CAN bus based bias signal.

Bias for analogue regulation

Parameter 7796 can be set with the type of input the DVC 550 should expect to receive if parameter 2783 is set to analogue.

To ensure that the DVC 550 is regulated from the AGC-4, parameter 5990 must be set to the correct transducer output that must give the bias to the DVC 550.

DAVR control

Parameter 7805 controls whether the AGC-4 should send commands and information in the CAN bus. This could, for example, be controlling the DVC 550 in switching regulation mode, and sets the knee set point and other settings/commands to the DVC 550.

It does not matter if **DAVR control** is set to ON or OFF as regards the bias signal. The AGC-4 is still able to regulate on the CAN bus based bias to the DVC 550. Parameter 2783 must then still be set to **EIC**, and the engine interface 7561 must be set to a J1939-based protocol.

If the AGC-4 has the control and the communication is up and running, it can be seen in the DEIF EasyReg Advanced software.

Settings controlled by the AGC-4 are shown greyed out, so these settings can only be changed from the AGC-4.



More information

See **Common DVC 550 settings** in this chapter for more information about the common settings for DVC 550.

The table below shows the parameters that are described above:

Parameter	Item	Range	Default	Note
7804	DVC 550 bias range for CAN bus-based regulation	0.1 % 30.0 %	10.0 %	Only in genset.
7805	Allow the AGC-4 to control DVC 550	OFF ON	ON	Only in genset.
7796	DVC 550 analogue bias input type	4 to 20 mA 0 to 10 V DC	0 to 10 V DC	Only in genset.

6.11 AGC-4 and DVC 550 cooperation

6.11.1 Nominal settings

When the CAN bus communication is established and the parameter 7805 for **DAVR control** is enabled, the AGC-4 controls the nominal settings in the DVC 550.

For rental customers, this can be helpful in cases where the gensets are exposed to different scenarios where different nominal settings can be required. By shifting the nominal settings in the DVC 550, it makes sure that the bias range is still the same even though the nominal voltage is either higher or lower.

The nominal settings that are sent automatically from the AGC-4 are active nominal voltage and frequency. So if the nominal setting is shifted between the four possible nominal settings, the active nominal settings will be sent automatically to the DVC 550.

6.11.2 Auto-view

If the CAN bus communication between the AGC-4 and the DVC 550 is established, the AGC-4 is able to display some values that it receives via the CAN bus. These values will be added to the 20 views that are already present in the AGC-4, so the total number of views will be expanded. It will still only be possible to configure the first 20 views.

The extra lines will be displayed if parameter 7564 is enabled and the CAN bus is active. Parameter 7564 will automatically switch to OFF again.

NOTE If the DVC 550 is mounted on a genset that also has an ECU, and the ECU also gives information via the CAN bus, then the ECU data might not be required to start the genset before toggling the auto-view to ON, because some ECUs only give information when the engine is running.

The parameter for auto-view:

Parameter	Item	Range	Default	Note
7564	Auto-view - enable	OFF ON	OFF	Only in genset. Note that it automatically switches to OFF again.

6.11.3 Communication error

When the settings regarding communication to the DVC 550 have been set, the AGC-4 has an alarm for checking the communication lines. If the communication between the AGC-4 and the DVC 550 suddenly stops, the AGC-4 creates the alarm **DAVR Comm. Err.**

The alarm is configured on parameter 7830, where it is also possible to set a fail class to activate if the **DAVR Comm. Err** alarm occurs.

The parameters used for the communication alarm error:

Parameter	Item	Range	Default	Note
7831	Digital AVR communication error - delay	0.0 s 100.0 s	0.0 s	Only in genset.
7832	Digital AVR communication error - output A	Not used Option-dependent	Not used	Only in genset.
7833	Digital AVR communication error - output B	Not used Option-dependent	Not used	Only in genset.
7834	Digital AVR communication error - enable	OFF ON	OFF	Only in genset.
7835	Digital AVR communication error - fail class	Block Trip MB/GB	Warning	Only in genset.

6.11.4 DVC 550 alarms on AGC-4

The DVC 550 can give two different levels of alarms:

- **DAVR Warning**
- **DAVR Trip**

This is enabled in menu 7760, in which it is also possible to set a fail class.

Parameter	Item	Range	Default	Note
7761	DAVR Warning	Block Trip GB Warning Trip+stop Shutdown Trip MB Safety stop	Warning	Only in genset.
7763	DAVR Trip	Block Trip GB Warning Trip+stop Shutdown Trip MB Safety stop	Warning	Only in genset.

6.11.5 DAVR info menu (jump 9090)

Jump menu 9090 shows information about DAVR software version and see any active alarms in the DAVR.

Parameter 9093 acknowledges any current active alarms and clears any alarms if they are no longer active.

Parameter	Item	Note
9091	DAVR SW version	Display of DAVR software version
9092	DAVR alarms	Display of all active alarms
9093	DAVR trip alarms	Display of active trip alarms (select to acknowledge alarms from the DAVR)

6.12 M-Logic related to DVC 550

6.12.1 M-Logic events, outputs and commands

M-Logic has many DVC 550 related events, outputs, and commands available for use.

Events

These are grouped under **DVC 550 events**:

▼ DVC 550 events

..... Stator current limitation off
..... Stator current limitation TM
..... Stator current limitation IM
..... Stator current limitation Active
..... LED: USB
..... LED: Power ON
..... LED: U=U
..... LED: PF kVAR
..... LED: I Exc.
..... LED: Diode fault
..... LED: Exc.
..... LED: Volt
..... LED: Hz
..... Any D550 warning alarms present
..... Any D550 trip alarms present
..... Alarm(Warning): Over voltage
..... Alarm(Warning): Under voltage
..... Alarm(Warning): Over frequency
..... Alarm(Warning): Under freq.
..... Alarm(Warning): Open diode
..... Alarm(Warning): Shorted diode
..... Alarm(Warning): Reverse P
..... Alarm(Warning): Reverse Q
..... Alarm(Warning): PT100 1 alarm
..... Alarm(Warning): PT100 1 fault
..... Alarm(Warning): PT100 2 alarm
..... Alarm(Warning): PT100 2 fault
..... Alarm(Warning): PT100 3 alarm
..... Alarm(Warning): PT100 3 fault
..... Alarm(Warning): PT100 4 alarm
..... Alarm(Warning): PT100 4 fault
..... Alarm(Warning): PT100 5 alarm
..... Alarm(Warning): PT100 5 fault
..... Alarm(Warning): PTC 1 fault
..... Alarm(Warning): PTC 2 fault
..... Alarm(Warning): PTC 3 fault
..... Alarm(Warning): PTC 4 fault
..... Alarm(Warning): PTC 5 fault
..... Alarm(Warning): Sensing lost
..... Alarm(Warning): Unbalanced U
..... Alarm(Warning): Unbalanced I
..... Alarm(Warning): Short circuit
..... Alarm(Warning): Excitat. chain
..... Alarm(Warning): Motor start
..... Alarm(Warning): Power bridge
..... Alarm(Warning): Batt supply low
..... Alarm(Warning): CAN supply low
..... Alarm(Warning): PT100 1 open/short
..... Alarm(Warning): PT100 2 open/short
..... Alarm(Warning): PT100 3 open/short
..... Alarm(Warning): PT100 4 open/short
..... Alarm(Warning): PT100 5 open/short
..... Alarm(Warning): AIN1 wirebreak

..... Alarm(Warning): AIN2 wirebreak
..... Alarm(Warning): AIN3 wirebreak
..... Alarm(Warning): AIN4 wirebreak
..... Alarm(Warning): AOUT1 overload/wirebreak
..... Alarm(Warning): AOUT2 overload/wirebreak
..... Alarm(Warning): AOUT3 overload/wirebreak
..... Alarm(Warning): AOUT4 overload/wirebreak
..... Alarm(Warning): DOUT overload
..... Alarm(Trip): Over voltage
..... Alarm(Trip): Under voltage
..... Alarm(Trip): Over frequency
..... Alarm(Trip): Under freq.
..... Alarm(Trip): Open diode
..... Alarm(Trip): Shorted diode
..... Alarm(Trip): Reverse P
..... Alarm(Trip): Reverse Q
..... Alarm(Trip): PT100 1 alarm
..... Alarm(Trip): PT100 1 fault
..... Alarm(Trip): PT100 2 alarm
..... Alarm(Trip): PT100 2 fault
..... Alarm(Trip): PT100 3 alarm
..... Alarm(Trip): PT100 3 fault
..... Alarm(Trip): PT100 4 alarm
..... Alarm(Trip): PT100 4 fault
..... Alarm(Trip): PT100 5 alarm
..... Alarm(Trip): PT100 5 fault
..... Alarm(Trip): PTC 1 fault
..... Alarm(Trip): PTC 2 fault
..... Alarm(Trip): PTC 3 fault
..... Alarm(Trip): PTC 4 fault
..... Alarm(Trip): PTC 5 fault
..... Alarm(Trip): Sensing lost
..... Alarm(Trip): Unbalanced U
..... Alarm(Trip): Unbalanced I
..... Alarm(Trip): Short circuit
..... Alarm(Trip): Excitat. chain
..... Alarm(Trip): Motor start
..... Alarm(Trip): Power bridge
..... Alarm(Trip): Batt supply low
..... Alarm(Trip): CAN supply low
..... Alarm(Trip): PT100 1 open/short
..... Alarm(Trip): PT100 2 open/short
..... Alarm(Trip): PT100 3 open/short
..... Alarm(Trip): PT100 4 open/short
..... Alarm(Trip): PT100 5 open/short
..... Alarm(Trip): AIN1 wirebreak
..... Alarm(Trip): AIN2 wirebreak
..... Alarm(Trip): AIN3 wirebreak
..... Alarm(Trip): AIN4 wirebreak
..... Alarm(Trip): AOUT1 overload/wirebreak
..... Alarm(Trip): AOUT2 overload/wirebreak
..... Alarm(Trip): AOUT3 overload/wirebreak
..... Alarm(Trip): AOUT4 overload/wirebreak
..... Alarm(Trip): DOUT overload

Outputs

▲ DAVR commands

..... Set stator current limitation off
..... Set stator current limitation TM
..... Set stator current limitation IM
..... Reset trip alarms

Commands

Two additional commands in M-Logic: Dry alternator and Ventilation.

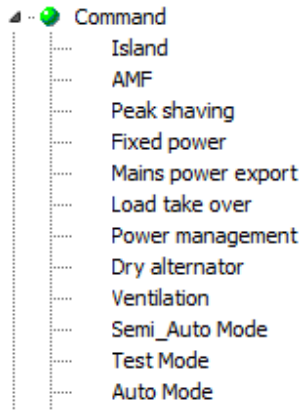

6.13 Common DVC 550 settings

6.13.1 Mixed applications

What is a mixed application?

A mixed application includes both AGC-4s and DVC 550s together with AGC-4s and DVC 310s in the same complete application. This could, for example, be a rental application.

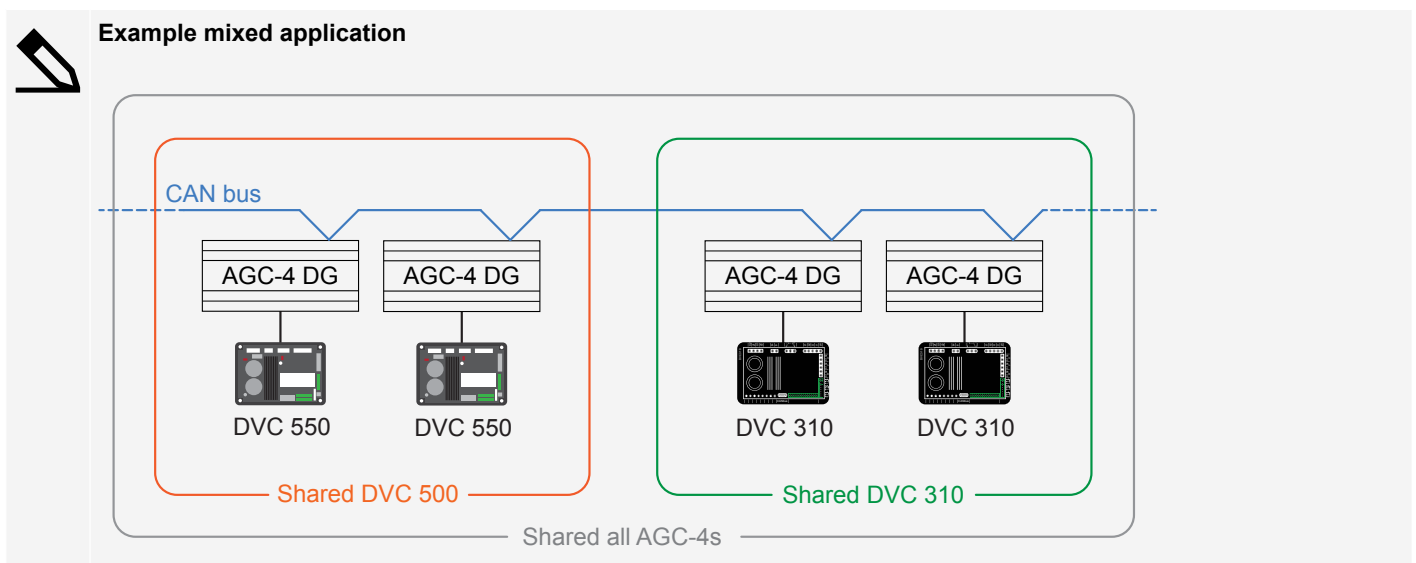

- These parameters are only shared between AGC-4s and DVC550s.
- These parameters are only shared between AGC-4s and DVC310s.
- These parameters are shared between all AGC-4s.

Shared parameters mean that if you change a parameter setting on one AGC-4 this setting is sent to all other AGC-4s in the system. The AGC-4s have the same setting when it is a shared parameter.

In mixed applications some parameters (shown in orange and green) are no longer shared between all the AGC-4s (shown in grey).

Table 6.3 Parameters not shared between DVC 550 and DVC 310 applications

Parameter	Parameter no.
U/f law slope	7772
Soft voltage recovery timer	7773
LAM + SVR Conf	7774
LAM set point	7775

These parameters must be configured for each group of controllers (shown in orange and green). That is to say, the parameters for AGC-4s with DVC 550s must be configured separately to the parameters for AGC-4s with DVC 310s. These parameters are no longer shared (shown in grey) between all AGC-4 DG units.

6.13.2 Shared parameters

The following parameters are shared between the AGC-4 controllers and between an AGC-4 and a DVC 550.



More information

For applications that include both AGC-4s with DVC 550s and AGC-4s with DVC 310s, see **Mixed applications** for more information about parameters that are not shared.

Parameter	Parameter no.	AGC DG to AGC DG	AGC-4 to DVC 550
CBE set point	2251	X	
CBE delay	2252	X	
CBE enable	2254	X	
CBE breaker sequence	2261	X	
CBE soft-start timer	2262	X	X
CBE RPM excite	2263	X	
Generator nominal voltage - nominal set 1	6004		X
Generator nominal voltage - nominal set 2	6014		X
Generator nominal voltage - nominal set 3	6024		X
Generator nominal voltage - nominal set 4	6034		X
Generator voltage transformer primary side	6041		X
Generator voltage transformer secondary side	6042		X
Busbar voltage transformer primary side - busbar nominal set 1	6051		X
Busbar voltage transformer secondary side - busbar nominal set 1	6052		X
Busbar voltage transformer primary side - busbar nominal set 2	6061		X
Busbar voltage transformer secondary side - busbar nominal set 2	6062		X
DVC 550 generator primary voltage	7741		X
DVC 550 generator secondary voltage	7742		X
DVC 550 busbar primary voltage	7743		X
DVC 550 busbar secondary voltage	7744		X

Parameter	Parameter no.	AGC DG to AGC DG	AGC-4 to DVC 550
DVC 550 voltage transformer enable	7745		X
Start-on threshold PWM	7751		X
Start-on threshold voltage limit	7752		X
Soft-start timer (Normal start)	7753		X
Minimum frequency threshold	7754		X
Minimum Vbus threshold	7755		X
Knee set point	7771	X	X
U/f law slope	7772		X
Soft voltage recovery timer	7773		X
SVR + LAM conf	7774		X
LAM set point	7775		X
LAM duration	7776		X
Q droop compensation set point	7781	X	X
U droop compensation set point	7782	X	X
Droop compensation type	7783	X	X
Excitation current for dry alternator mode	7791		X
Transformer excitation set point for current	7793		X
Inductive motor starting set point for current	7794		X
Stator current limitations enable	7795		X
Bias analogue	7796		X
PID Gain	7801		X
Write all settings to DVC 550	7803		X
DVC 550 bias range	7804		X
DVC 550 controls	7805		X

6.14 Modbus communication

6.14.1 Modbus communication

This chapter is additional information for option H2/N (Modbus RS-485 RTU).

If option H2/N is installed, the data can be transmitted to a PLC, a computer, the alarm-and-monitoring system or a Scada system.



More information

Please refer to the technical documentation for **Option H2 and H9 Modbus communication** and **Option N Modbus TCP IP** available on the DEIF homepage : <https://www.deif.com/products/agc-4#documentation>

The data readable by the Modbus communication are converted into the chosen unit in menu 10970.

6.14.2 Modbus table

Function code 4			
Address	Bit	Content	Note
916		AVR generator AC Voltage [V]	
917		AVR generator frequency [Hz] 1/10	
918		AVR generator AC current [A]	
919		AVR field excitation current [A] 1/10	
920		<i>Not used</i>	
921		AVR generator reactive power	
922		AVR generator Power Factor [] 1/100	
923		AVR generator Power Factor lagging	00= lagging 01= leading
924		<i>Not used</i>	
925		Total Power	
926		<i>Not used</i>	
927		AVR generator apparent power	
928		AVR Pt100 1 temperature [deg C/F]	
929		AVR Pt100 2 temperature [deg C/F]	
930		AVR Pt100 3 temperature [deg C/F]	
1056	0	AVR comm. error	
	1	AVR Warning	
	2	AVR Trip	
	3-15	<i>Not used</i>	
1365	0	USB LED	
	1	POWER LED	Function code 4
	2	U = U	
	3	PF kVAR	
	4	I Exc.	
	5	Diode fault	
	6	Exc. fault	
	7	Voltage fault	
	8	Frequency fault	
	9-15	<i>Not used</i>	

Function code 4

Address	Bit	Content	Note
1366	0	Over voltage	
	1	Under voltage	
	2	Over frequency	
	3	Under frequency	
	4	Open diode	
	5	Shorted diode	
	6	Reverse P	
	7	Reverse Q	
	8	PT100 1 alarm	
	9	PT100 1 fault	
	10	PT100 2 alarm	
	11	PT100 2 fault	
	12	PT100 3 alarm	
	13	PT100 3 fault	
	14	PT100 4 alarm	
	15	PT100 4 fault	
1367	0	PT100 5 alarm	
	1	PT100 4 fault	
	2	PTC 1 fault	
	3	PTC 2 fault	
	4	PTC 3 fault	
	5	PTC 4 fault	
	6	PTC 5 fault	
	7	Sensing lost	
	8	Unbalanced U	
	9	Unbalanced I	
	10	Short circuit	
	11	Excitat. chain	
	12	Motor start	
	13	Pwr bridge	
	14	Batt supply lo	
	15	CAN supply low	

Function code 4

Address	Bit	Content	Note
1368	0	PT100 1 op/sho	
	1	PT100 2 op/sho	
	2	PT100 3 op/sho	
	3	PT100 4 op/sho	
	4	PT100 5 op/sho	
	5	AIN1 wirebreak	
	6	AIN2 wirebreak	
	7	AIN3 wirebreak	
	8	AIN4 wirebreak	
	9	AOUT1 ol/wb	
	10	AOUT2 ol/wb	
	11	AOUT3 ol/wb	
	12	AOUT4 ol/wb	
	13	DOUT overload	
14-15	<i>Not used</i>		

7. Troubleshooting

7.1 Preventive maintenance instructions





During a downtime period for the alternator, it is recommended to:

- Check the wires are tight in the connectors.
 - Torque setting between 0.6 Nm and 0.8 Nm.
- Blow dry air through to get rid of any dust that may have settled on or around the DVC 550.
- Check there is free circulation of air around the aluminum heatsink at the front of the device.
- Check the running time counter.
 - If this exceeds 40,000 hours, consider changing the AVR.

7.2 Troubleshooting

Issues can occur on the AVR which may lead to its replacement.

The main faults are listed below:

Fault	Cause(s)	Solution	Restart action(s)
Voltage sensing fault.	Alternator sensing VT broken.	Replace faulty VT.	<ol style="list-style-type: none"> 1. Stop the alternator. 2. Replace faulty VT. 3. Restart the alternator.
	Internal measurement broken.	Replace the AVR.	 More information See Replace AVR for how to replace.
Excitation fault.	<ul style="list-style-type: none"> • Faulty component. • Opening of the field excitation circuit which caused a voltage surge on the transistor. 	Replace the AVR.	 More information See Replace AVR for how to replace.
24 V DC auxiliary supply fault.	External supply fault.	Replace the 24 V DC power supply.	<ol style="list-style-type: none"> 1. Stop the alternator. 2. Replace faulty power supply. 3. Restart the alternator.
	Voltage converter fault.	Replace the AVR.	 More information See Replace AVR for how to replace.
The AVR is not responding (display frozen, no communication).	Microcontroller fault.	Replace the AVR.	 More information See Replace AVR for how to replace.
The regulation mode controlled by an input is not active.	Faulty input.	Switch control of the regulation mode to another input	<ol style="list-style-type: none"> 1. Stop the alternator. 2. Configure new settings. 3. Restart the alternator.
		Replace the AVR.	 More information See Replace AVR for how to replace.
	The wiring is faulty	Check that the input has been enabled by shunting the 0 V and the local input and checking the input state on the HMI.	Restart the alternator.

Fault	Cause(s)	Solution	Restart action(s)
The field excitation does not start.	Faulty starting input	Switch control of starting to another input	1. Stop the alternator. 2. Configure new settings. 3. Restart the alternator.
	The AVR power is not switched on.	Check the VBus voltage on the HMI.	Restart the alternator.
	The 24 V DC power supply is faulty	Check that the AVR is powered up by looking at the HMI LEDs. Power ON ●	Restart the alternator.
Regulation of the power factor is unstable.	The active power is too low to have a correct power factor measurement.	Use kVAr mode for low load regulation (less than 10% of rated load)	1. Stop the alternator. 2. Configure new settings. 3. Restart the alternator.
	The stator current measurement is incorrect.	Check the CT wiring on the current measurement input and the CT.	Restart the alternator.
		Replace the AVR if the wiring is correct.	 More information See Replace AVR for how to replace.

7.3 Replace a faulty DVC 550

DANGER!

Hazardous live currents and voltages



Risk of electrical shock and/or damage

While the AVR is in operation, do not unplug any connectors or make any wiring modifications. This may lead to electric shock and/or destruction of the AVR and/or damage to the alternator.

NOTICE

Configuration changes during operation

Possible damage to equipment

Modifications to the main alternator settings, such as: machine data, voltage and current measurement transformer wiring, upper or lower reference limits, or starting control, must be made when the alternator stopped.

NOTICE

Operating range

Possible damage to equipment

The operating ranges must always be adhered to. Changing the settings to inappropriate voltages or currents may cause partial or total destruction of the AVR and/or alternator.

NOTICE

Power input protection

Possible damage to equipment

The power input must be protected by a circuit-breaker or fuses in order to avoid irreparable damage to the AVR in the event of short-circuit or voltage surge.

NOTICE

Installation/Replacement

The installation/replacement must only be carried out by authorised personnel who understand the risks involved in working with electrical equipment.

To replace a faulty DVC 550 AVR:

1. Stop the alternator (if not already done).
2. Switch off and electrically isolate the auxiliary supply and power supply.
3. Check that no voltage is present.
4. Carefully remove all the AVR connectors, noting their positions.
5. Undo all the AVR mounting brackets so it can be removed from the installed location.
6. Using DEIF EasyReg Advanced upload your configuration project to the new DVC 550 AVR.
7. Disconnect the DVC 550 USB cable.
8. Fix the new DVC 550 in place of the faulty AVR.
9. Reconnect all the connectors on the new AVR.
10. Power up the auxiliary supply and check that the AVR is energized.
11. Start up the alternator drive system.
12. Power up the power supply without exciting the machine.
13. Before exciting the alternator, check the alternator voltage measurement and power supply voltage (VBus).
14. Switch on the alternator excitation.
15. Check all the AVR measurements and regulation modes, and any controlled outputs.

8. End-of-life

8.1 Disposal of waste electrical and electronic equipment

WEEE symbol

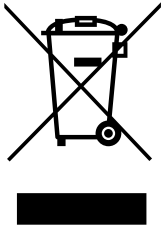

All products that are marked with the crossed-out wheeled bin (the WEEE symbol) are electrical and electronic equipment (EEE). EEE contains materials, components and substances that can be dangerous and harmful to people's health and to the environment. Waste electrical and electronic equipment (WEEE) must therefore be disposed of properly. In Europe, the disposal of WEEE is governed by the WEEE directive issued by the European Parliament. DEIF complies with this directive.

You must not dispose of WEEE as unsorted municipal waste. Instead, WEEE must be collected separately, to minimise the load on the environment, and to improve the opportunities to recycle, reuse and/or recover the WEEE. In Europe, local governments are responsible for facilities to receive WEEE. If you need more information on how to dispose of DEIF WEEE, please contact DEIF.

9. Glossary

9.1 Terms and abbreviations

Term	Abbreviation	Explanation
Alternating current	AC	
Analogue input	AI	Terminals on a controller hardware module that the controller uses to measure an analogue input. The analogue input type and range are typically selected during commissioning from a list of pre-configured voltage, current, and resistance measurement input ranges. A pre-configured analogue input function or alarm can also be assigned to the input.
Analogue input or output	AIO	
Analogue output	AO	Terminals on a controller hardware module that the controller uses to send an analogue output. The analogue output type and range are typically selected during commissioning from a list of pre-configured voltage and current output ranges. A pre-configured analogue output function can also be assigned to the output.
Auxiliary winding regulation excitation principle	AREP	Auxiliary windings installed in the machine which are used to supply the AVR with power. They often consist of 2 windings: the first "H1" which is affected by voltage variations, the second "H3" which is affected by current variations.
Configuration		Assigning input and output functions to terminals, and setting parameters, so that the controller is suitable for the application where it is installed.
Current transformer	CT	A transformer for the current measurements.
Insulated gate bi-polar transistor	IGBT	A three terminal power semiconductor device, primarily used as an electronic switch for high efficiency and fast switching.
Digital input	DI	Terminals on a controller hardware module that the controller uses to measure a digital input. A pre-configured digital input function or alarm can be assigned to the input.
Digital input or output	DIO	
Direct current	DC	
Digital output	DO	
Earth		A connection between the equipment and earth. For marine applications, a earth is a connection to the ship's frame.
Neutral	N	The neutral line in a three-phase electrical system.
Parameter		A value, or set point, used to determine the controller's operation. Parameters include nominal values, the configuration options for the configurable inputs and outputs, and alarm settings. The same set of parameters can be uploaded to several controllers.
Phase U	U	The power line for one phase of a three-phase electrical system. Corresponds to R in Germany, Red in the UK and Pacific, Red in New Zealand, Black in the USA, and U on electrical machine terminals. The above colour codes are for guidance only. If uncertain perform a phase measurement.
Phase V	V	The power line for one phase of a three-phase electrical system. Corresponds to S in Germany, Yellow in the UK and Pacific, White in New Zealand, Red in the USA, and V on electrical machine terminals. The above colour codes are for guidance only. If uncertain perform a phase measurement.
Phase W	W	The power line for one phase of a three-phase electrical system. Corresponds to T in Germany, Blue in the UK and Pacific, Blue in New Zealand, Blue in the USA, and W on electrical machine terminals. The above colour codes are for guidance only. If uncertain perform a phase measurement.

Term	Abbreviation	Explanation
Permanent magnet generator	PMG	
Pt100		Platinum temperature sensor
Pulse width modulation	PWM	Terminals with an output that uses variable pulse widths, and behaves as an analogue output.
Single-phase		A system where the load is connected between one of the phases and the neutral. Note: Single-phase does NOT mean a 3-wire single-phase distribution system, where the waveforms are offset by a half-cycle (180 degrees) from the neutral wire.
Voltage	V	Electrical potential difference. U is used as an abbreviation for voltage in most of Europe, Russia and China.
Voltage transformer	VT	A transformer for the voltage measurements, so that the voltage at the controller is within the controller's specifications.

9.2 Vector permutations

If only one stator current measurement CT is wired up, the vector permutations can compensate for voltage measurement and current measurement transformer layouts which generate incorrect power and power factor (cos phi) calculations.

The DVC 550 must be wired according to the position of the stator current measurement if only one stator current measurement CT is used. The table below gives the possible permutations according to the phase used for the stator current measurement CT.

Table 9.1 Single CT wiring guidelines for DVC 550

Position of stator current measurement CT	Alternator direction of rotation (a/c IEC 60034-1)	Alternator voltage measurement			
		AVR terminals	U	V	W
Phase V (standard)	Clockwise	Alternator phases (three-phase measurement)	U	V	W
		Alternator phases (phase/phase single-phase measurement)	U	-	W
	Anti-clockwise	Alternator phases (three-phase measurement)	W	V	U
		Alternator phases (phase/phase single-phase measurement)	W	-	U
Phase U	Clockwise	Alternator phases (three-phase measurement)	W	U	V
		Alternator phases (phase/phase single-phase measurement)	W	-	V
	Anti-clockwise	Alternator phases (three-phase measurement)	V	U	W
		Alternator phases (phase/phase single-phase measurement)	V	-	W
Phase W	Clockwise	Alternator phases (three-phase measurement)	V	W	U
		Alternator phases (phase/phase single-phase measurement)	V	-	U
	Anti-clockwise	Alternator phases (three-phase measurement)	U	W	V
		Alternator phases (phase/phase single-phase measurement)	U	-	V